

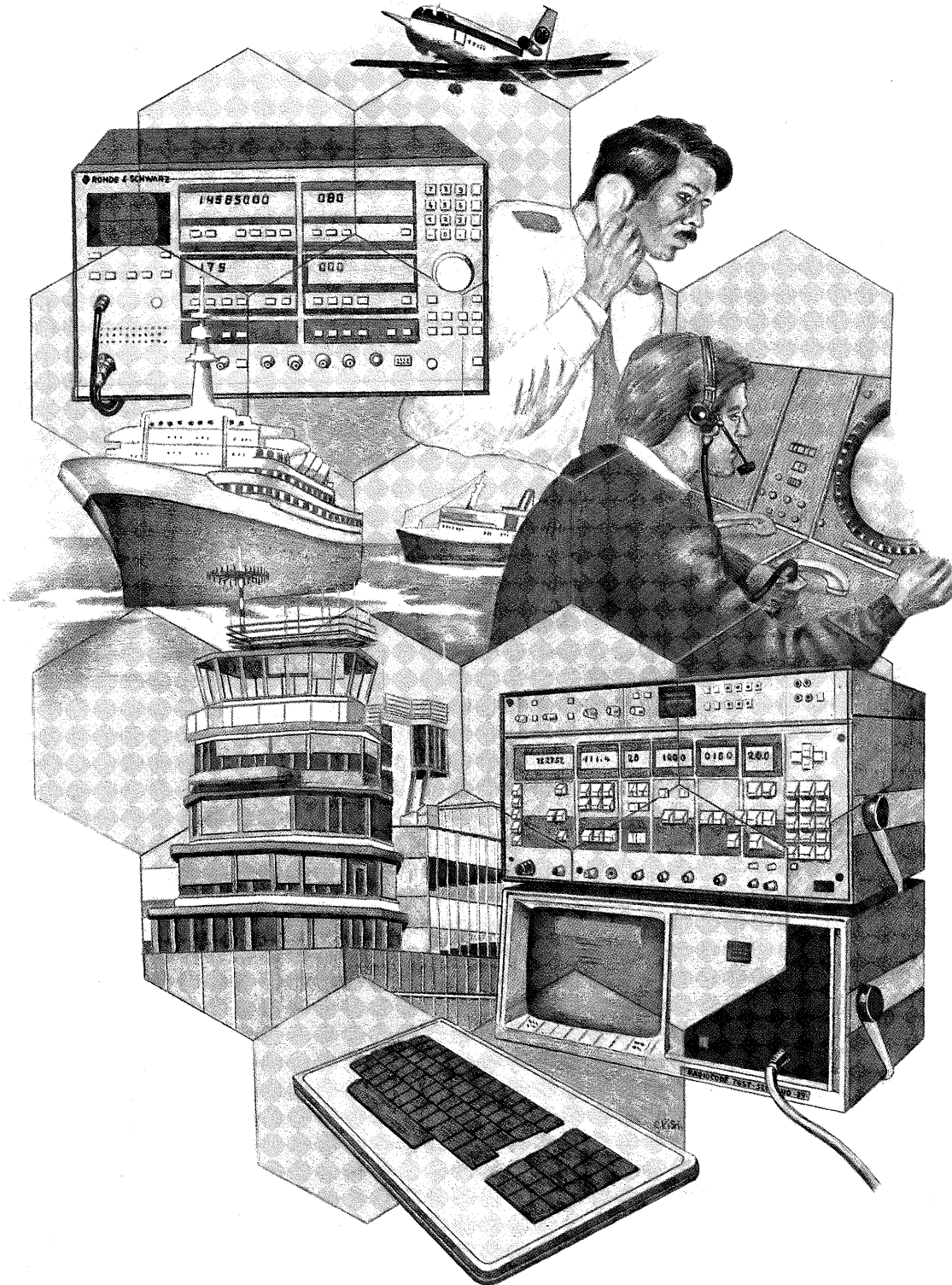

ROHDE & SCHWARZ

NEWS
FROM
ROHDE & SCHWARZ
special 2



Radiotelephone measurements

Radiotelephone measurements

special 2

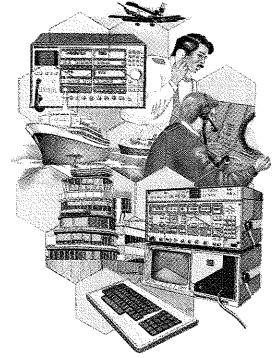

Radiotelephone measurements

All about measuring and testing radiotelephones: the design and operation of radiotelephone test assemblies from Rohde & Schwarz, permit regulations and relevant technical specifications, cellular radio, measurements on radiotelephones for cellular-radio networks such as AMPS, TACS, NMT or Network C, selective call and radio data, the PCA computer concept in transceiver testing, modulation analysis, power and VSWR measurements, signal generators for two- and multi-signal measurements, automatic assemblies for laboratory and acceptance measurements, solutions for user-specific measuring tasks.

Introduction

David Picken

The world of mobile radio 6

Articles

Gert Lehning

Permit regulations and technical specifications for radio installations. 9

Michael Vohrer

Radiocommunication Tester CMT – intelligent radiotelephone allrounder from 0.1 to 1000 MHz. 13

Michael Vohrer

Duplex radiotelephone test sets Mobile Testers SMFP 2 and SMFS 2. 28

Manfred Großmann

From selective call through radio data to cellular radio 41

Michael Vohrer

Radiocode Test Set SCUD for selective calling, radio data and cellular radio. 49

Michael Vohrer

Cellular-radio test assembly for AMPS, TACS and NMT 58

Thomas Maucksch

Measurements on network-C radiotelephones using Radiocommunication Tester CMT 63

Franz Lüttich

Four for any occasion 68

Franz Dosch

The PCA computer concept in transceiver testing. 78

Philip McDouall

Modulation analysis from 55 kHz to 1360 MHz with FAM 83

Klaus Thomé

Power and VSWR measurements in radiotelephony. 86

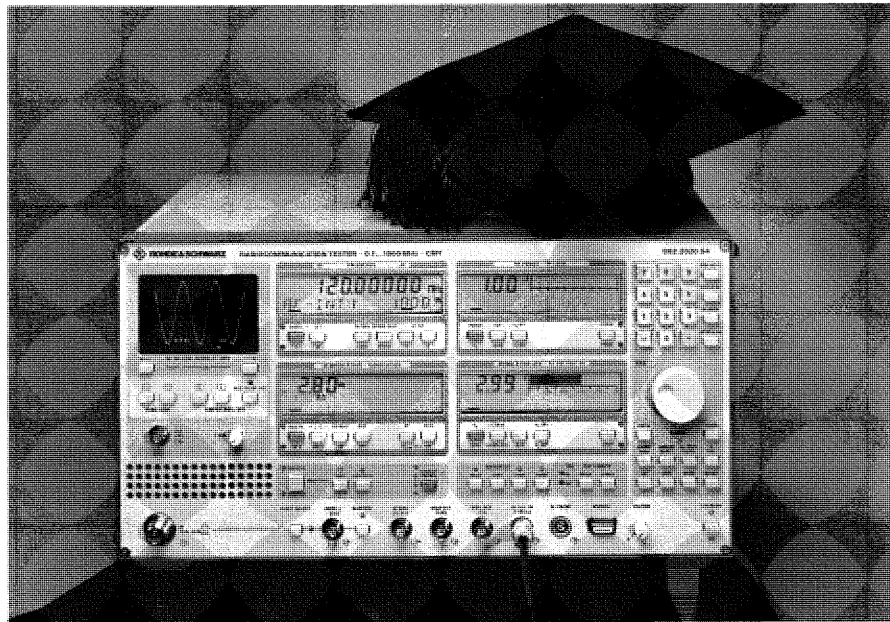

Radiocommunication Tester CMT, a compact and low-cost radiotelephone test set, can handle all measurements even on ultramodern AM, FM and ϕ M transceivers and is obsolescence-proof to a high degree thanks to its broad choice of options for extension. Its low weight makes it ideally suited for mobile use.

Mobile Testers SMFP 2 and SMFS 2 for manual or automatic operation incorporate ultramodern transceiver measurement features for all applications associated with servicing, development, quality assurance and production. The systems can be matched to special measuring problems in an economical manner by using suitable options. New measuring devices and a full-duplex deviation meter satisfy exacting measuring demands, especially with mobile stations of cellular-radio networks.

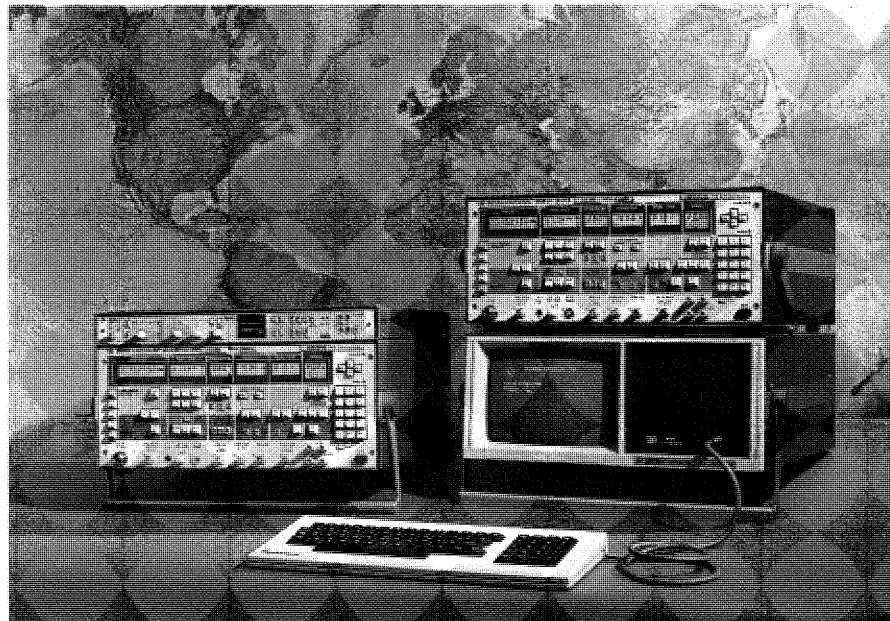

Signal Generators SMG, SMK, SMPC and SMPD are four universal signal sources for radiotelephone measuring applications. Combined with other measuring instruments, these signal generators are an alternative to complete radiotelephone test assemblies. Their balanced graduation according to the different focal points of application and their price make them an optimum instrumentation range.



Interviews: Thirteen users in administrations and industry were asked about their experience with radio test equipment from Rohde & Schwarz. But first there is a look at the production of radio test assemblies at the R&S plant in Memmingen (Allgäu), showing how strongly production is influenced by quality assurance and certification.

Alfred Weinberger
RF, AF and DC voltmeters
from Rohde & Schwarz 89

David Picken
Multi-function test set or
discrete instrumentation? 92

Application notes

Hans-Joachim Jonas
Automatic test assemblies for
laboratory and acceptance testing . . . 95

Interviews

Production of radio test assemblies . . .	100
Simulating complex radio systems . . .	102
Professional sets for professional customers	103
Customized adaptation and speedy service	104
Radiocommunications in service to the public	105
In-house testing guarantees the lead	107
Test system proven under rough conditions	108
Of AMPS, NMT, TACS and Co.	110
World fame starts in development . . .	111
A lot to do in the test-shop	112
A firm grip on complex signalling	113
Putting equipment to the acid test . . .	114
Storno calling – over	116
Measuring when the day is done	117

The world of mobile radio

Mobile-radio services are experiencing tremendous growth throughout the world. **Two-figure growth rates** have characterized radio services in almost every country in recent years, making radiocommunications one of the giants in the electronics sector together with entertainment and data processing. The driving forces behind this upward trend are new technologies, extended frequency bands and a general **rise in the public interest in communication**. What are these radio services, and what is the role of measurement engineering in the construction, commissioning and maintenance of such radio networks?

Leaving aside amateur radio and the specialized field of sound and television broadcasting, we are still confronted by a vast spectrum of services both for civil and military applications. The distinction usually made by the postal authorities in classifying services as "public" or "private" gives little indication of the technical background. For a test-equipment manufacturer it is of only secondary interest to know whether the radio service is linked to the "public" telephone network or to a "private" communications system.

Much more important for those involved in the technical side of things are the **type of traffic**, the form of **modulation** used, the **frequencies** occupied and the **signalling procedures**. We shall now take a closer look at the more important radio services based on these criteria.

The first distinction in the **type of traffic** must be made between **one-way** and **two-way** communications. The first case permits communication in a single direction only while the second case makes **information exchange** possible.

A typical example of one-way communication is the paging system, in which users carrying a small, portable receiver may be reached at any time within a certain coverage area. The area covered may be as small as the precincts of a hospital but could also be extended to cover whole countries, as is the case in the **Europaging Service** which presently ranges over West Germany, France and Switzerland. As a contrasting example to the paging systems, in which relatively few transmitters serve a large number of receivers, we may consider **emergency-call systems** as used in forestry. Here a small number of very sensitive receivers listen continuously for signals from low-power transmitters carried by the foresters for use only in emergencies (FIG 1).

In both these examples of one-way communication the reaction of the person at the receiving end must be fixed in advance. A pager user will normally go to the nearest public phone to call an agreed number in order to find out the reason for the page call. The reception of a signal in an alarm system will automatically lead to localization and rescue procedures being put into action. Thus both are situations in which **signalling** takes place, **without any special need for information exchange**.

FIG 1 Examples of one-way communication are a paging system in a hospital or the emergency-call system of forestry workers.

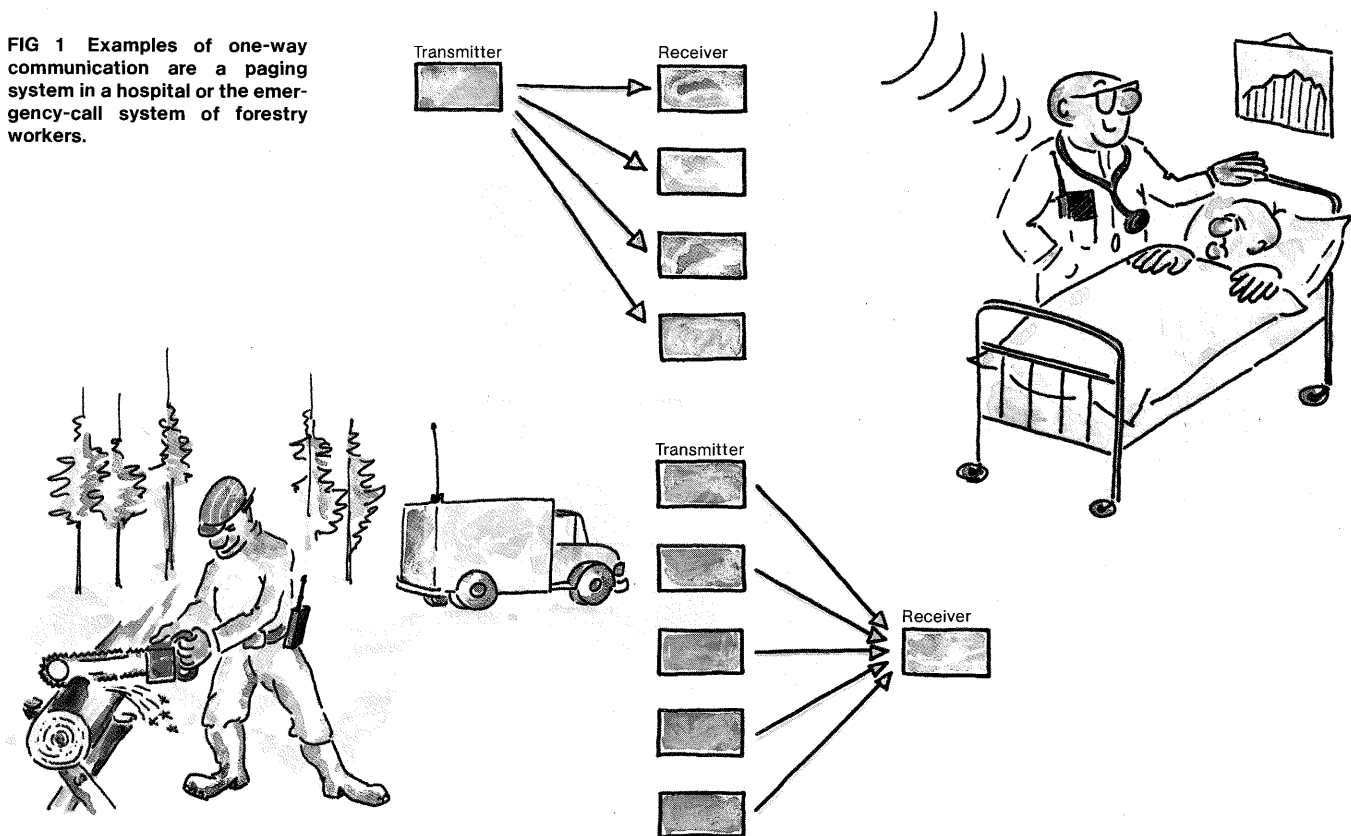

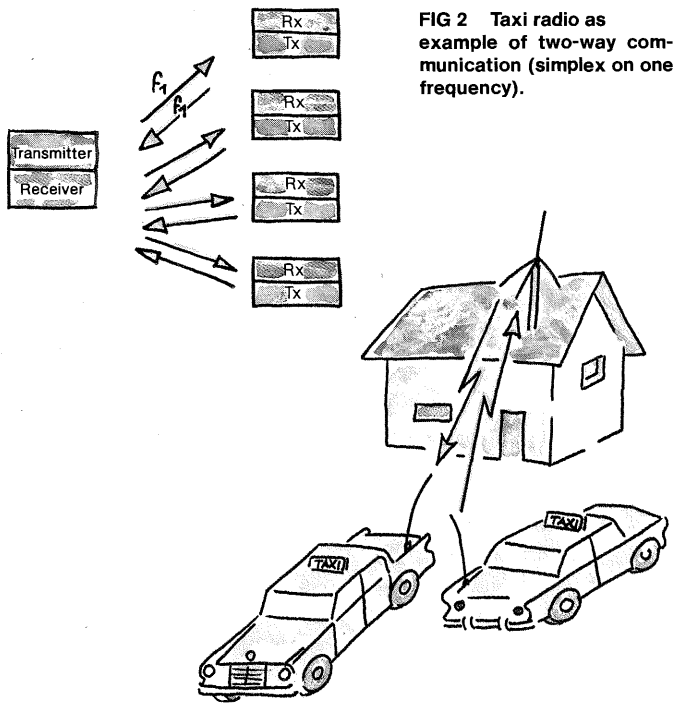

FIG 2 Taxi radio as example of two-way communication (simplex on one frequency).

Whenever such an exchange of information becomes necessary **two-way communication** comes into its own. To economize on the use of the frequency spectrum and to keep the complexity of the radios down to a minimum, many services do without the luxury of simultaneous transmission and reception. These two basic elements of communication then take place consecutively – the technical term used is **simplex** (FIG 2).

This mode of working is very common where time is not a critical factor. It calls for a certain degree of discipline on the part of the users and is not quite as comfortable as using an ordinary telephone.

To be able to talk and listen simultaneously over the airwaves a separate frequency must be provided for each direction. This traf-

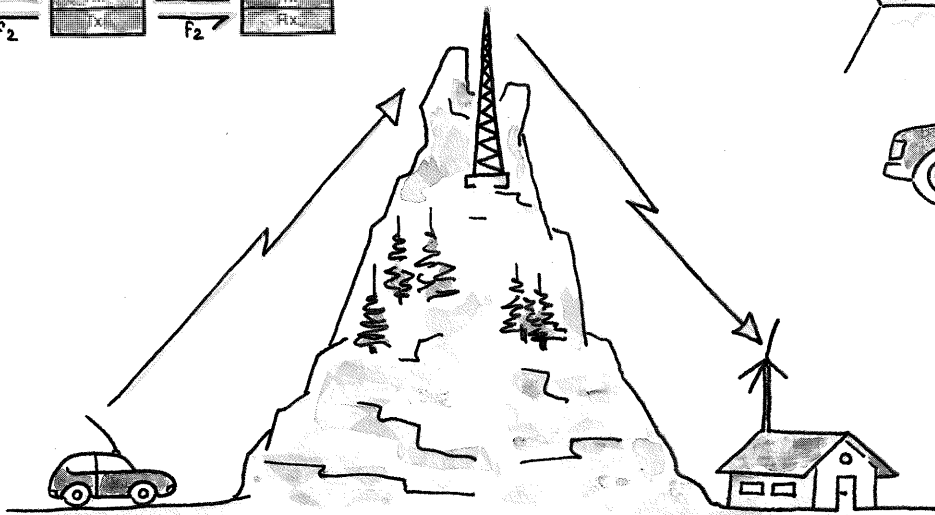
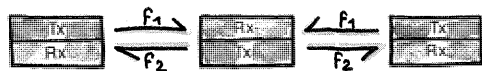

FIG 4 Repeater station increases radio coverage. Traffic is handled on two frequencies.

fic mode, known as **full-duplex**, has proved to be essential when radio systems are linked to the public telephone service as in the car telephone. Full-duplex working is also desirable in other situations, such as in security and rescue organizations, where fast reactions are called for and the occasional need to interrupt the flow of conversation may well arise (FIG 3).

Between full-duplex and simplex working we also encounter the **semi-duplex** mode in which each channel occupies two frequencies – one for each direction – although **simultaneous transmission and reception are not possible**. This technique makes for better coverage and intelligibility in applications which do not call for direct links between mobile users but rely mainly on communication between a fixed base station and a number of mobiles. Typical users are taxis and public transport authorities.

Repeater stations can be used to extend the range of coverage. These are usually unattended stations which convert the received signal to a new frequency before retransmitting it. In a simplex system, a repeater or relay station requires two frequencies per channel. For duplex working a total of four frequencies will be needed.

FIG 3 The car telephone typifies full-duplex traffic on two frequencies.

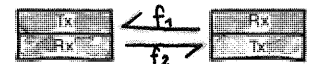

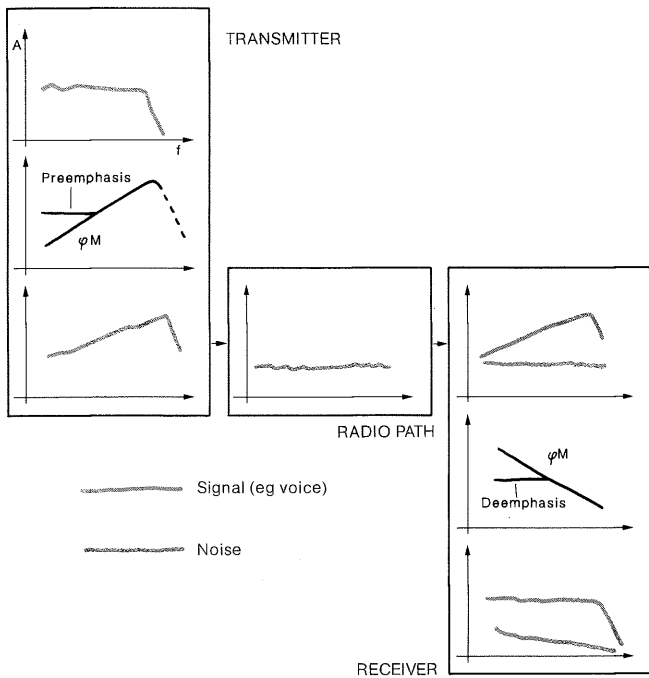
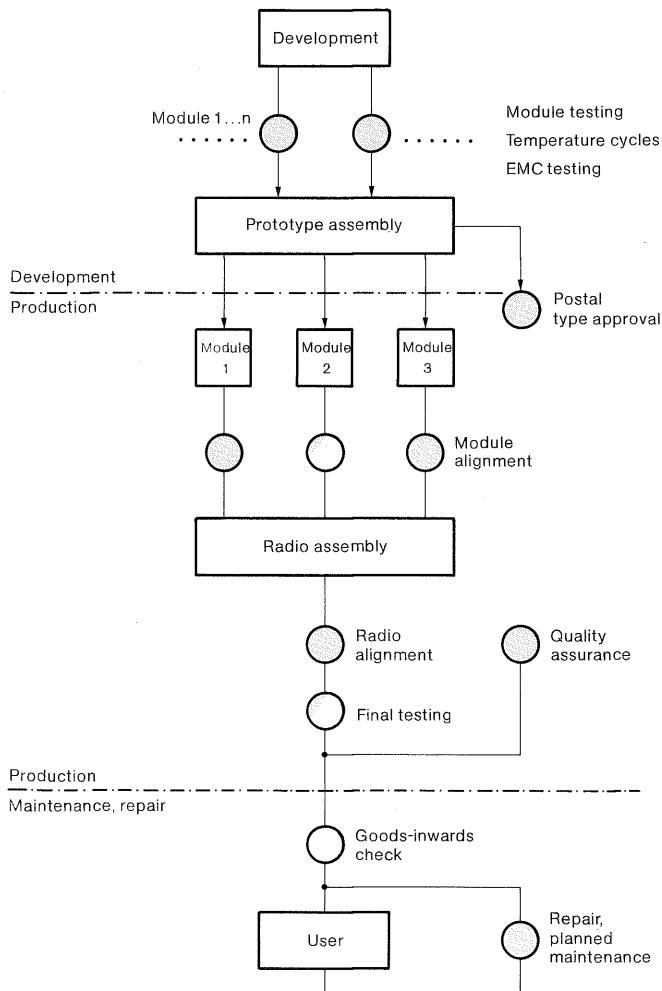

FIG 5 Use of phase modulation or preemphasis (in transmitter) and deemphasis (in receiver) reduces effect of noise in transmission path.



Most mobile-radio services today use **frequency modulation**. In some cases **phase modulation** or FM with preemphasis is used to improve the received signal/noise ratio (FIG 5). One major exception is the air-traffic control service, in which **amplitude modulation** is still the accepted norm. In the military sector both AM and **single-sideband (SSB) modulation** are to be found.

The available spectrum for mobile radio is so small in relation to the enormous demand that a high degree of economy is called for. Thus the past decades have seen the normal **channel spacings** reduced: from 50 kHz to 25 kHz or 20 kHz. In some countries users must even make do with only 12.5 or 10 kHz.

Although many radios still use individual quartz crystals to determine the working frequency, the number of radios based on **frequency synthesis** is increasing rapidly. For the radio manufacturer this means the advantages of digital electronics, permitting circuits for the generation of any frequency to be miniaturized to a great extent. The user also benefits from added **flexibility**, because his radios can now be modified for use at **any allocated frequency** in a very short time.

The ever increasing density of users has motivated engineers to search for new ways of improving the efficiency of spectrum use. The various **calling techniques** are the result of this endeavour, starting with simple, single-tone codes and fixed pilot tones and continuing through five-tone selective calls to complex digital call telegrams. The basic aim of all these methods is one and the same: to allow **several users to work on a single carrier frequency** without interfering with one another. In the most modern networks signalling procedures even take over the selection of working frequency and radiated power as a means of optimizing reception quality.

Each of the parameters discussed above – traffic type, modulation, channel spacing, frequency and signalling – has a specific effect on the required performance of suitable test and measurement instrumentation. The aim of this special issue will be to put Rohde & Schwarz's current program of mobile-radio test equipment in the correct perspective relative to the requirements of everyday working. Test and measurement accompany a mobile radio from its conception in the development laboratory through all the various stages of production and postal type approval up to and including the necessary maintenance and repair (FIG 6).

Radiocommunication is inconceivable without the corresponding measurements, since it is only possible to communicate on the basis of agreed and reproducible parameters.

David Picken

FIG 6 Test stations in the life of a typical radio.

Anyone who installs and operates radio equipment will usually require a permit from a national post and telecommunications administration (except military applications). It does not matter whether the equipment is used for the remote control of toys, for sound broadcasting, for radio-relay systems or for any other transmitting or receiving purposes. In the Federal Republic of Germany the permit is required under the Law concerning Telecommunication Installations, which also specifies that the right to install and operate telecommunication systems, ie radio equipment, lies exclusively with federal authorities. This right can be, but need not be granted to others. It is conferred in the form of a permit for the installation and operation of telecommunication systems. The permit conditions are laid down by the Federal-German Post and Telecommunications Administration in consideration of national interests as well as international contracts and recommendations.

Permit regulations and technical specifications for radio installations

Only persons or organizations complying with the legal, operational and technical requirements for the field of application concerned and proving a need for communication that cannot be satisfied by wired telecommunication systems or the public telephone network or would then involve unreasonable expenditure will be granted a permit. If radio services are concerned that are expected to be of wide public interest, details of the permit will be published in the official gazette of the Federal-German Ministry for Post and Telecommunications. Frequently the technical requirements which are part of the permit regulations are issued separately in the form of **specifications of the FTZ** (Telecommunications Engineering Centre).

In most cases – especially with regard to mass-produced radio equipment – the permit is subject to official tests and approval carried out by the **Central Approval Authority for Telecommunications Equipment**, which also publishes the approval procedure. The technical prerequisite for approval is compliance with FTZ specifications.

There is a large variety of radio services (FIG 1) and a correspondingly large number of permit regulations and technical specifications. Therefore this article cannot go into details, but instead will review the general principles, objectives and the background.

First, there is the question of the necessity of checking demand and of applying restrictive operational and technical permit regulations. Because of the great and ever increasing need for communi-

cation the frequency spectrum must be utilized in the best possible manner. Restriction to absolutely necessary radio applica-

tions, systematic frequency-utilization planning, international coordination and use of spectrum-efficient techniques are a must.

In addition, radio installations are not only sources or sinks of information but also potential sources of interference for other radio services and radio stations, as they might impair distant common channels or produce interference on frequencies other than the useful one. The keyword in this connection is **electromagnetic compatibility** (EMC), which is becoming ever more important because of the increasingly dense network of potential sources and sinks of interference. To achieve electromagnetic compatibility RFI radiation and conducted interference must be suppressed to a degree sufficient for the particular field of application, and furthermore guidelines for the **immunity** of radio installations to interfering fields have to be observed.

It is evident that access limitations, systematic planning, coordination, extensive EMC analyses and the resulting technical and operational specifications must be established to ensure optimal utilization of the frequency spectrum, to satisfy the great demand for wireless communication and to maintain interference-free radio traffic on a national and international level. Therefore **binding regulations** are required.

Anyone who develops, imports or purchases radio equipment on the market must abide by these regulations and make sure in good time that the equipment is **capable of being licensed**. For the development and testing of radio equipment, the testing of new operating techniques as well as for research and training regi-

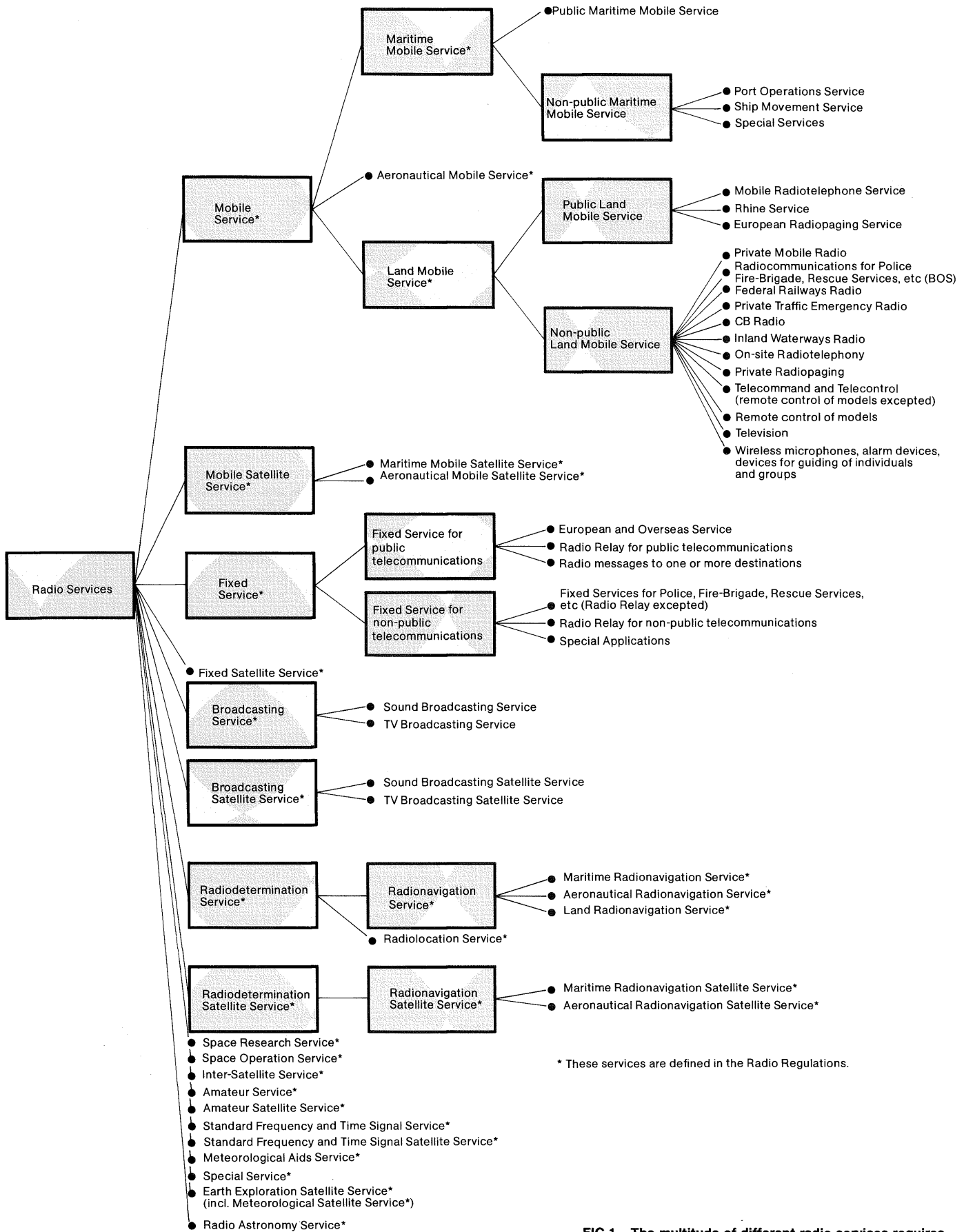

FIG 1 The multitude of different radio services requires binding regulations to ensure optimum utilization of the available frequency spectrum.

onal PTT directorates can grant test permits on request. In the absence of specific regulations for the case under consideration, an application stating all technical and operational aspects should be filed with the FTZ of the Federal-German Post and Telecommunications Administration, which will check the data in respect of radio compatibility and permit regulations and submit them to the Federal-German Ministry of Post and Telecommunications for a decision.

In most cases, however, regulations and technical specifications exist. It is necessary to distinguish between

- general permits and
- individual permits.

Individual permit means that in each case the future user needs a permit for the installation and operation of the radio equipment or system. The permit is usually subject to a fee and has to be applied for from the regionally competent telecommunications authority. The Federal-German Post and Telecommunications Administration thus knows the holder of the permit and the place or zone of use. With **general permits** the situation is quite different. Radio installations that meet the valid technical specifications of the Federal-German Post and Telecommunications Administration, are approved by it and operated according to permit regulations do not require an individual permit. In the past the permits always referred to **installation and operation**. As regards radio systems for land-mobile services, new methods have now been applied. Under certain conditions installation is subject to a general permit, whereas in many cases operation still requires an individual permit.

Generally speaking, the Federal-German Post and Telecommunications Administration endeavours to issue general permits as widely as possible, as this is not only in the interests of the users but also simplifies administrative procedures and reduces costs. **Individual permits**, however, will still be required whenever a transmitter network has to be planned systematically, when local conditions (eg topography, vegetation, buildings, vicinity to frontiers) have to be taken into consideration for the permit and when the radio installations have high radio-interference potential, which must be known to the Federal-German Post and Telecommunications Administration in view of local EMC analysis and interference handling.

In individual cases it may even be necessary to carry out **local EMC measurements** prior to licensing a system. But this must not become the rule because of the difficulties and expenditure involved. A test at the installation site is superfluous if technical testing of mass-produced samples and approval of the type under consideration by the Central Approval Authority for Telecommunications Equipment guarantee that technical specifications are complied with. Nevertheless, there may sometimes be radio interference, since the limit values defined always represent compromises that take into account not only EMC but also technological and economic aspects such as production costs and market conditions. The limit values do not allow for rare, extremely unfavourable decoupling conditions between interference source and interference sink.

In addition to their main purpose of promoting wireless communications, the technical specifications serve other purposes like

- optimum spectrum utilization,
- minimization of electromagnetic incompatibility between radio services,
- elimination of trade barriers by international harmonization.

Consequently the technical specifications are divided into system and planning values, parameters causing reception degradation in other radio installations, parameters for the suppression of interference caused by stray fields, and parameters for satisfying transmission characteristics. All of the parameters are subject to measurements and tests in the course of development, production, approval procedure and service.

The **system and planning values** include the allocated frequency range, assigned channel, type of modulation, necessary and occupied bandwidth, transmitting power, effective antenna height, directional characteristics of the antenna, necessary protection ratio and to some extent receiver sensitivity.

Parameters that can degrade radio reception are spurious emissions (harmonics, spurious frequencies, intermodulation products), out-of-band emissions, which are often also expressed as adjacent-channel power, as well as receiver radiation.

Among the **parameters dealing with susceptibility to interference from stray fields** number spurious response, co-channel rejection, adjacent-channel selectivity and blocking.

Examples of parameters describing **transmission characteristics** are AF response of transmitter and receiver, distortion and AF output power. Transmission characteristics indirectly influence spectrum utilization, since bad transmission characteristics reduce comprehensibility and increase error rates, which can only be compensated for by prolonged or repeated channel occupancy.

In the following some of the parameters and criteria involved in defining limit values are explained in greater detail.

Frequency allocation

The **allocation of frequency ranges** to radio services is given in the national table of frequency allocations, which is based on the **Radio Regulations**. These represent an annex to the International Telecommunications Treaty prepared by the **International Telecommunication Union (ITU)** in the course of administrative radio conferences. The Treaty has furnished the prerequisites for radio traffic across borders and mutual compatibility of radio services on an international level. The Radio Regulations are **binding** on the contracting partners. However, the various national tables of frequency allocations differ because of regional differences already allowed for in the Radio Regulations and multiple allocations (with different protection rights) in numerous frequency ranges which allow the administrations a choice.

Necessary bandwidth

The **necessary bandwidth** is defined as the width of the frequency band which is just sufficient to ensure in a given class of emission the transmission of information at the rate and with the quality required under specified conditions. The **occupied bandwidth** is understood to mean the frequency bandwidth at which the mean powers emitted below and above the frequency limits are equal to a specified percentage $\beta/2$ (in most cases 0.5%) of the total mean power of a given emission. The **assigned frequency band** comprises the necessary bandwidth plus twice the absolute value of the frequency tolerance. The necessary bandwidth depends on the bandwidth of the message (AF bandwidth, transmission rate), the type of modulation and indirectly on the necessary S/N ratio at the receiver output. In consideration of the transmission quality and rate specifications it should be as small as possible to comply with the need for optimum spectrum utilization. However, several parameters partially counteract each other, so compromises have to be made. An example of this is the frequency deviation or modulation index in the case of frequency or phase modulation. The S/N ratio at the demodulator output rises proportionally to the frequency deviation, but at the same time the necessary bandwidth increases as well. The **co-channel rejection**, however, improves as the modulation index increases.

The ability to suppress spurious signals in the useful channel also depends on the type of modulation. **CCIR** for example, a **radio consultative committee of ITU**, recommends a ratio between wanted and unwanted signal of 18 dB for amplitude-modulated mobile radio services, but of only 8 dB for frequency- and phase-modulated radio services. In the case of FM or PM the same channel can be reassigned at a considerably smaller distance away than in the case of AM. Under certain conditions the advantages offered by AM in respect of bandwidth are completely eliminated.

Transmitting power, antenna height and receiver sensitivity are parameters which influence each other. With higher receiver sensitivity transmitting power or antenna height can be lower than with receivers of inferior sensitivity. Any reduction of the transmitting power will reduce the interference range. On the other hand, sensitive receivers are easily disturbed by **man-made noise**, which may be very high in industrial conurbations. This problem will become even more urgent with the increase in digital data processing and digitization of communications networks because of the wide interference spectra associated with high pulse repetition frequencies and steep pulse edges. It is also critical if, in radio networks of land-mobile services, receivers are used that are much more sensitive than those provided for in planning. With increasing useful range mobile radio stations approach distant common-channel ranges more than intended, thus causing interference. For more forceful advertising the manufacturers unfortunately often show a tendency to promote receiver sensitivity at the expense of other important parameters such as attenuation of intermodulation products.

To ensure EMC between radio services it is particularly important to limit **spurious emissions** and **radiation from receivers**. At present the limit values for spurious emissions in the broadcast ranges are usually stricter than in other frequency ranges, since broadcast-reception disturbance is quite frequent due to the large number of interference sinks and the vicinity of potential interference sources. In the past, relatively strict values were therefore required to limit interference. Considerable problems in respect of other

radio services have so far not occurred. This means that less strict limit values are applicable to the corresponding frequency ranges. With the increase in the density of radio stations and in the number of potential interference sources this situation will have to change. An example for clarification: As a rule, the limit value for spurious emissions beyond the broadcast ranges presently amounts to $0.25 \mu\text{W}$. Referred to a $\lambda/2$ dipole the interference field strength at a distance of 300 m from the interference source is still over $20 \mu\text{V/m}$. It is only a question of probability whether such interference field strength will disturb occupied channels in this range.

If an increase in interference probability is to be expected as a consequence of changing boundary conditions, the limit values must be adapted in good time, like other technical specifications on account of continued development.

For quite some time now, the technical specifications have ceased to be a purely national matter. Mainly with regard to economic aims such as opening up of markets and elimination of trade barriers, but also in the interest of international telecommunications the limit values and test methods are discussed in international bodies. ITU and CCIR have already been mentioned; other important bodies working in the field of radiocommunications are the **International Electrotechnical Commission (IEC)** and the **Conference of European Post and Telecommunications Authorities (CEPT)**.

Gert Lehning*

* Gert Lehning is a section leader at the Telecommunications Engineering Centre (FTZ) of the Federal-German Post and Telecommunications Administration and responsible for matters of RFI suppression.

Easy operation, a wide variety of possible measurements and an exceptionally favourable cost/performance ratio are the major features of a new radiotelephone test set from Rohde & Schwarz. This is the Radiocommunication Tester CMT, which has been specially developed as a service test set. Its compact design, low weight and battery powering mean that it is particularly suitable for mobile use; its high measuring quality and comprehensive range of features also enable universal stationary operation.

Radiocommunication Tester CMT – intelligent radiotelephone allrounder from 0.1 to 1000 MHz

FIG 1 High intelligence of Radiocommunication Tester CMT results from large storage capacity, ability to automatically carry out complex test routines and learning ability for large number of test sequences.

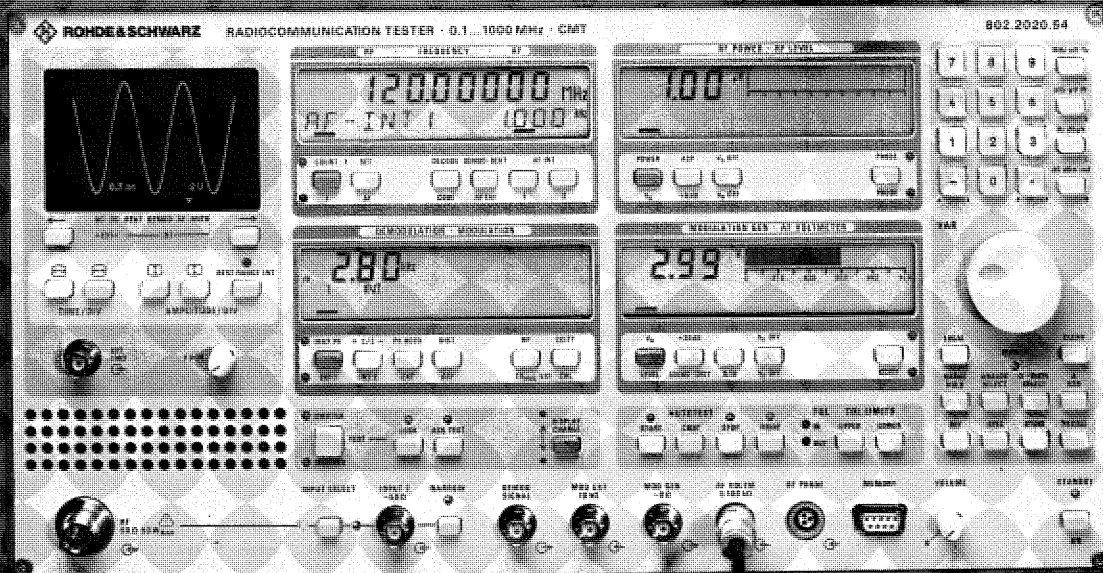

Radiocommunication Tester CMT is a system for many applications in the field of radiotelephone measurements. Manual and automatic operation, mobile and stationary use, universal measuring capabilities and a fast measuring rate, together with the high technical specification, allow versatile application of the instrument in all radiotelephone fields (FIG 1). Thanks to its small, compact design, low weight and battery powering the CMT is particularly suitable for all mobile and stationary servicing tasks.

The broad choice of options, numerous special functions for particular settings and measurements, semi-automatic test procedures and the nonvolatile memory with additional storage facility for complete front-panel settings, frequencies and special functions are the prerequisites for its wide range of use.

In spite of its low price, the CMT contains all the facilities required for precise measurements on AM, FM and ϕ M transceivers, featuring a high dynamic range and fast measuring rate. The tester can be controlled manually, fully automatically via the built-in autorun control including printout facility (no external controller required) or via the IEC/IEEE bus using an external controller.

The basic version of the CMT contains no oscilloscope (FIG 2). An alternative model is available with an oscilloscope perfectly matched to the requirements of transceiver testing. This is not

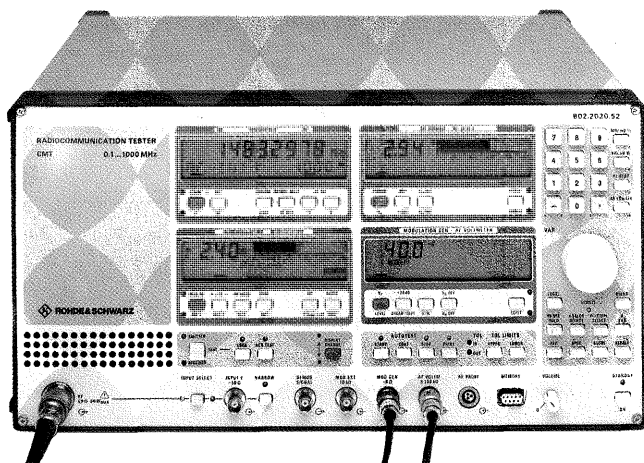

FIG 2 Radiocommunication Tester CMT model 52 without oscilloscope.

only valuable for mobile use; thanks to its automatic settings and many special functions it is also a valuable aid for stationary measurements.

Due to the CMT's compatibility with practically all transmission and coding techniques in modern radio networks and those expected in the future, as well as specific extension facilities, it is obsolescence-proof to an optimum degree.

Operation

The front-panel controls and displays of the CMT are arranged in different sections according to type of measurement, instrument setting and measurements to be carried out. Different colour codes used for marking the keys and LEDs provide clear front-panel layout by using red for transmitter and green for receiver tests.

The logically organized front panel guarantees errorfree operation with no learn phase and extremely fast access to the measuring facilities, the automatic test routines and test-parameter setting or variation. Automatic settings for certain operating modes free the user from repetitive routine settings and are the basis for efficient measurement of all radio-specific parameters.

The CMT also offers test routines for results which are derived from several settings and measurements. These routines can be called up either by a single key (eg S/N or adjacent-channel power measurement) or via the keypad as special functions. For instance the CMT determines receiver sensitivity for a user-defined S/N or SINAD value by varying the RF level. The bandwidth of a receiver is determined in line with the relevant standard by searching for the 6-dB noise limits and deriving the receiver centre frequency together with its offset from the nominal value. The CMT also includes an automatic test routine for squelch response level and hysteresis.

The execution of even complex routines remains transparent since test parameters and measured values are continually displayed and the alphanumeric display provides information on the individual steps of a sequence (FIG 3).

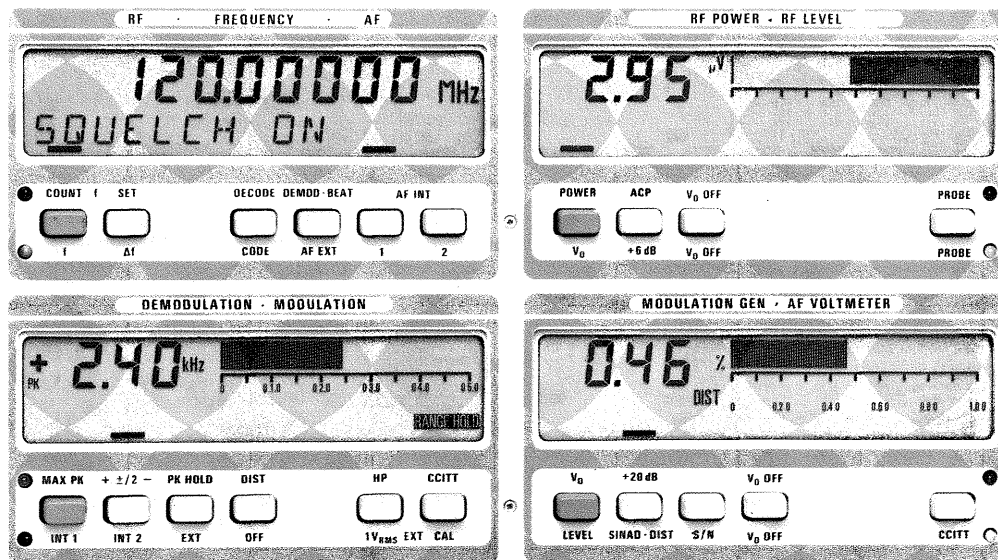

FIG 3 Displays on CMT with multicolour key inscriptions, red for transmitter test and green for receiver test, and measured-value displays in digital and analog form. Coloured LEDs indicate set operating mode. All controls are arranged directly below corresponding display; selected functions are indicated in plain text and/or with LCD bars/LEDs.

Switchover between transmitter and receiver tests can be triggered either automatically (by the transmitter power of the transceiver) or manually. Parts of the transmitter and receiver tests can be combined as required, each individual measuring facility being directly addressable. All test parameters and other test settings are stored when another operating mode is selected and are automatically reset when recalled.

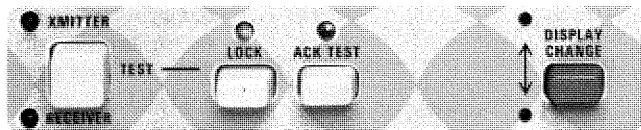

FIG 4 Keypad for transmitter/receiver switchover with LOCK function and control for acknowledge call (ACK).

For measurements on radiotelephones with acknowledge call the CMT switches to transmitter testing immediately after the radiotelephone is on the air, automatically determines call number and modulation and indicates these on the relevant displays. FIG 4 shows the corresponding keypad.

Test parameters can be entered or varied on the keypad or by means of the spinwheel. Direct input is possible in all units with conversion capabilities available on the keypad (FIG 5). For fast selection of parameters the CMT accepts inputs without a unit and

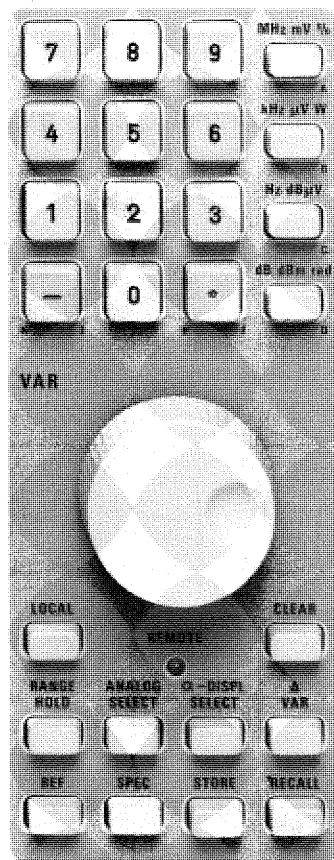

FIG 5 Universal keypad of CMT for entry of test parameters and conversion of units.

uses the unit indicated on the display. The result is displayed as an absolute value with unit or as a relative value in dB or % with the current measured value as the reference or with a reference value preset on the keypad, eg for frequency-response measurements.

Variation steps can be selected as linear or logarithmic for each parameter separately using the spinwheel. The magnetic detent of the spinwheel allows particularly sensitive setting.

Keypad polling and display of results operate according to the firmware-controlled multitasking mode using time-division multiplex and ensure extremely fast response time of the test set to test-parameter inputs or variations as well as very short measuring times irrespective of operator control and number of current measurements. Lagging of the measured-value display while test parameters are being varied does not occur with the CMT.

The measured values are indicated clearly and simultaneously on the digital and analog displays and on the integrated oscilloscope, ensuring ergonomic operation in manual mode. The autorun control facility and printer interface to the CMT allow automatic measuring sequences to be generated and stored. The IEC/IEEE bus permits the CMT to be extended to a fully automatic, universal radiotelephone test facility with remote computer control. In both modes relays in the CMT are available for controlling a transceiver during the automatic test.

Displays

The CMT features four large illuminated LCDs with five digital displays for simultaneous indication of all measured values and setting parameters with units. Three additional analog displays with resolution of 1% and clear, automatic scaling as well as a selectable RANGE HOLD function provide ideal conditions for measurements and all kinds of adjustment. Time constants can be selected to match the displays perfectly to the various requirements.

The selected mode (eg + PK, RMS deviation, etc) and conditions (eg weighting filter switched on) are also indicated for all measurements. Additional information such as 1st modulation, 2nd modulation or fine variation of RF level contributes to a clear test-parameter display.

The full-scale values of the analog displays are optimally matched to the particular measurement. For instance a 5-kHz range is available for FM measurements and a 25-dB range for SINAD measurements. In addition to the RANGE HOLD function, the full-scale values can be directly entered using the keypad for specific alignment operations.

The simultaneous display of results in analog and digital form combines the detection of trends, the determination of variations in the measured values and the reading of precise values in an ideal manner. The simultaneous display of different but related results – for example deviation as a digital value and distortion as an analog value – greatly clarifies the relationship between the individual values (FIGs 6 and 7).

An additional alphanumeric display indicates all results which require additional explanation to enable simple interpretation, as well as the selection of special functions and the execution of automatic test routines. As a means of communication between

RADIOCOMMUNICATION TESTER CMT

Display of:
 transmitter modulation distortion (with or without 300-Hz highpass or CCITT filter)
 selected modulation (Int. 1, Int. 2, Ext.)

Display of:
 transmit frequency, nominal frequency
 RF setting
 selective call and DTMF: decoding and coding
 AF measurement: demodulated signal, beat signal, AF signal (external)
 frequency of AF generator
 operator prompts

AF oscilloscope (model CMT.54)

RF input
 RF output

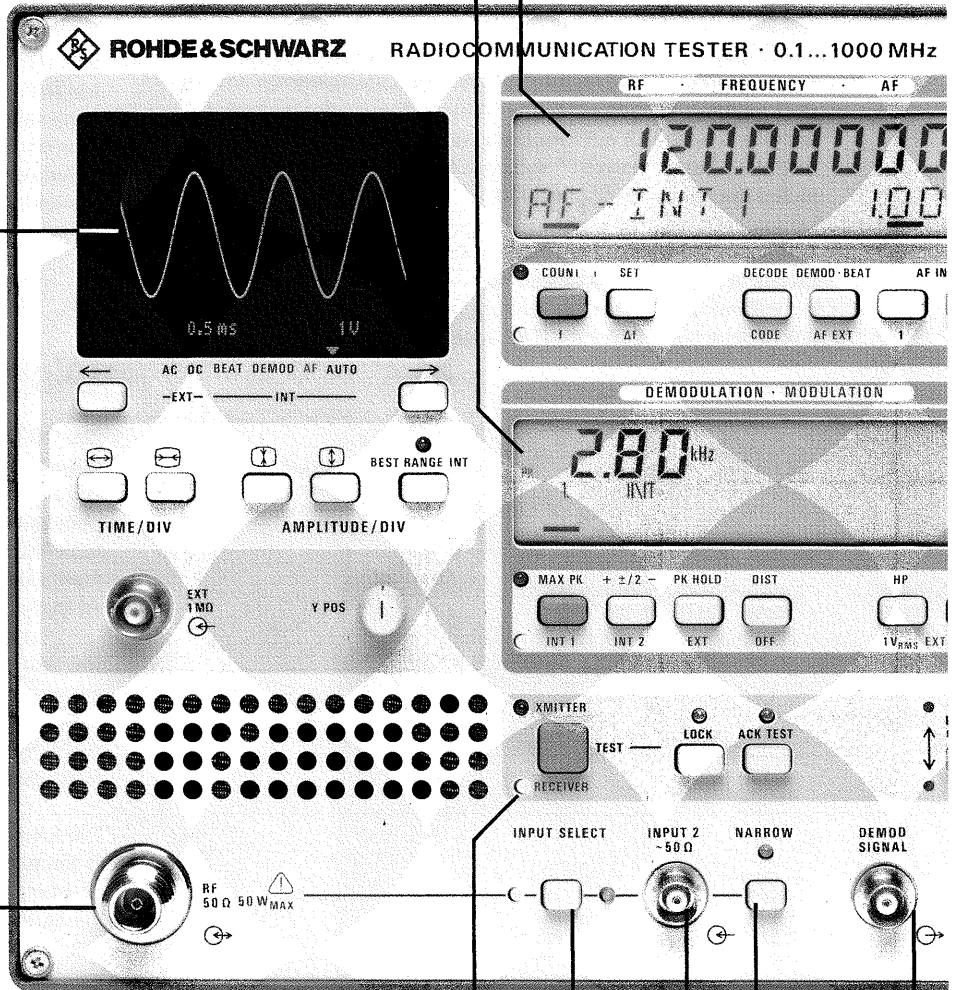

Transmitter and receiver test selector
 Acknowledge-call test
 Display switchover

Bandwidth
 RF input 2

RF-input selector

Sensitive RF input (off-air measurement)

Demodulated-signal output measurement

Red: transmitter measurement
 Green: receiver measurement
 Black: transmitter and receiver measurement

FRONT-PANEL DETAILS

Display of:

transmitter power
adjacent-channel power
RF-level setting
RF-voltage measurement with probe or insertion unit

Display of:

AF-level setting
AF-voltage measurement
distortion, S/N and
SINAD measurements (with or without CCITT filter)

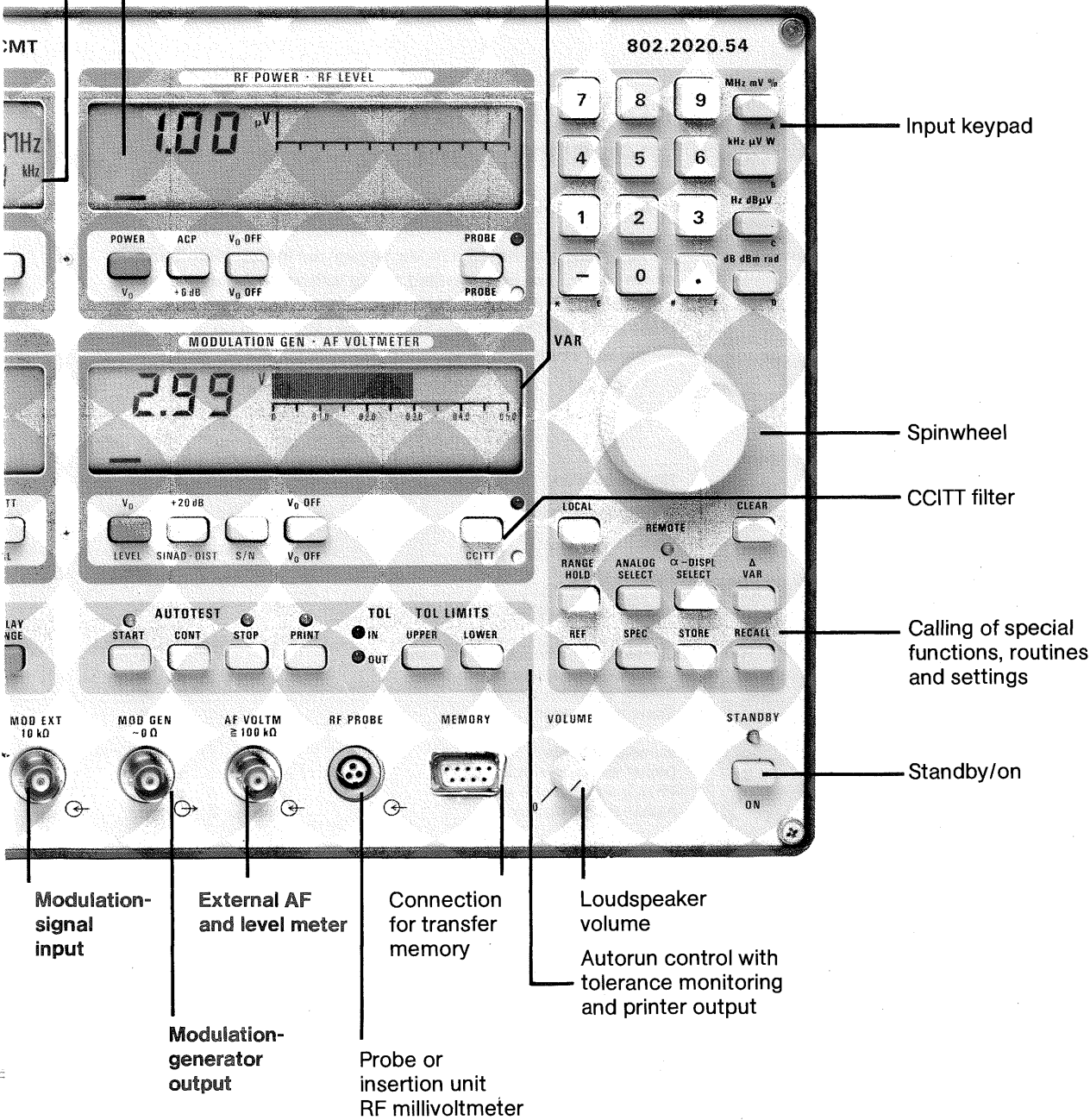

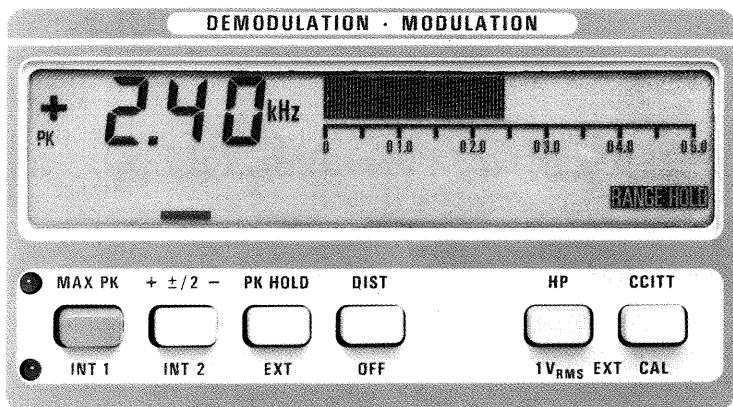

FIG 6 Indication of measured modulation in analog and digital form, here frequency modulation.

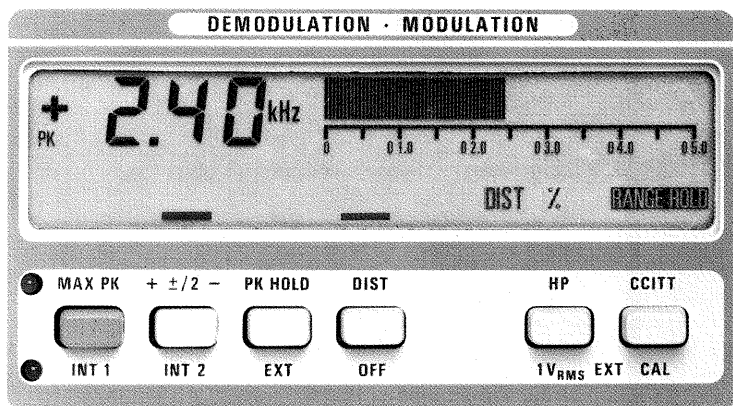

FIG 7 Two related results simultaneously shown on same display, here deviation (digital readout) and distortion (analog display).

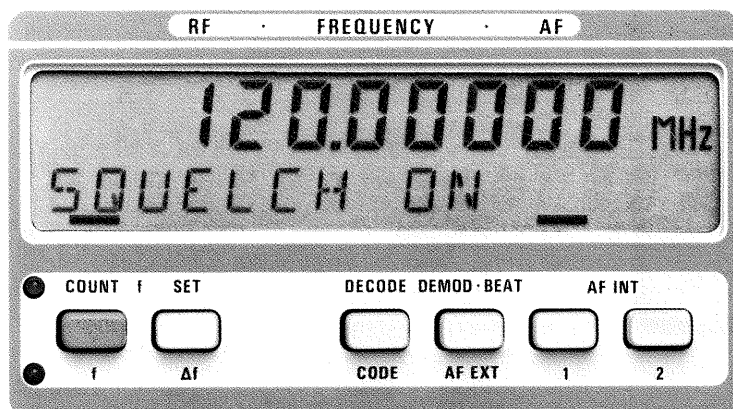

FIG 8 Alphanumeric display on CMT for special measured values, special functions and as general communication aid between user and test set.

TABLE Summary of exceptional CMT characteristics for individual fields of application.

user and test set it provides user prompts (FIG 8), is used in writing test sequences in conjunction with the autorun control facility and also outputs user prompts during the automatic test sequence.

Its general-purpose design makes the CMT suitable not only for use in servicing but also for further applications in radiotelephone measurements; the most prominent features for the individual fields of application are listed in the TABLE.

Fully automatic measurement

In addition to the automatic test routines and the IEC/IEEE-bus option, the autorun control/printer interface option is available for automation. In the learn mode, sequences for **complete transceiver testing** can be generated simply without an external controller, stored in a nonvolatile memory and recalled at any time (FIGs 9 and 10). The memory has capacity for storing up to 100 simple test sequences or up to 20 extensive transceiver tests.

Mobile service

Stationary service

Module testing

Final testing

Incoming inspection

Lightweight, compact, easy to handle
 Requiring little space
 Battery operation possible
 Standby operation

Illuminated LCDs
 Digital readouts with units
 Analog displays with scaling
 Alphanumeric display

All measuring facilities provided
 Fast measuring rate
 High accuracy
 Wide dynamic range
 Off-air measurement

Automatic test routines
 Automatic test run
 Remote-control facility
 Printer connection
 Go/Nogo test

Wide choice of options
 Designed for the future
 Integrated oscilloscope

○ = of advantage, ● = necessary

Lightweight, compact, easy to handle	●	●
Requiring little space	○	●
Battery operation possible	○	●
Standby operation	○	○
Illuminated LCDs	○	●
Digital readouts with units	○	●
Analog displays with scaling	○	●
Alphanumeric display	○	●
All measuring facilities provided	●	○
Fast measuring rate	○	●
High accuracy	○	○
Wide dynamic range	○	○
Off-air measurement	○	○
Automatic test routines	●	○
Automatic test run	●	○
Remote-control facility	●	○
Printer connection	●	○
Go/Nogo test	●	○
Wide choice of options	○	○
Designed for the future	○	○
Integrated oscilloscope	○	○

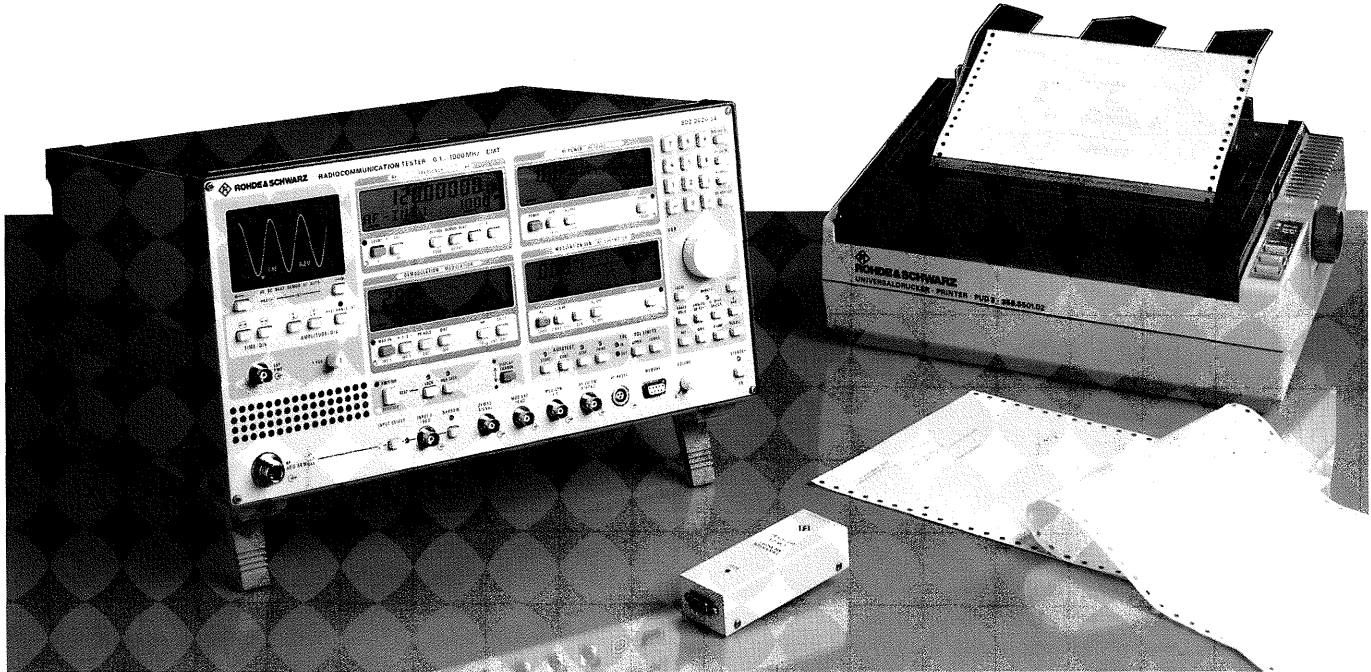

FIG 9 Radiocommunication Tester CMT with Printer PUD 2/3 forming fully automatic radiotelephone test assembly without external process controller.

A test sequence is defined as in manual mode by simply entering the desired test parameters or by calling up a particular measurement and then pressing the STORE key. All functions of the CMT, including complete instrument settings, special functions and automatic test routines, are included in this. It is additionally possible to enter upper and lower tolerance limits for the measure-

design but with different RF frequencies, or multichannel transceivers and radiotelephones differing only in their call number (Europaging receivers) without any additional effort.

For portability of test routines to other test assemblies a small, battery-buffered semiconductor memory module, which can be plugged onto the front panel, is available as a Transfer Memory (accessory CM-Z1) (FIG 12).

A large number of remarks are available for user prompts during the automatic test run which may be suitably integrated in the program. These remarks are output in plain text on the alphanumeric display at the proper time – typically in combination with stop functions – and request the operator to take corresponding actions, eg to send call tone, switch from transmitter to receiver test, switch squelch on/off or carry out adjustments.

A check is made by calling up the individual sequence steps or simply by stepping up and down with the magnetically locking

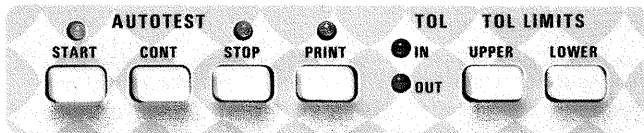

FIG 10 Keypad for automatic measurement on CMT.

ments. Each entry such as transmitter test, RF level, SINAD measurement is a sequence step. All steps are consecutively numbered and shown on the alphanumeric display. For setting the transceiver to the desired operating mode for measurement, all control relays contained in the CMT may be integrated (FIG 11).

The insertion of stop functions is particularly useful. Continuous stops and wait loops are possible. In the case of a continuous stop the CMT interrupts the automatic test sequence and enables the user to carry out manual settings such as switching from receiver to transmitter test, switching squelch on/off, starting selective call, etc (if these cannot be controlled automatically). Wait loops – set in 10-ms steps – are required to allow for transients of the transceiver (channel change, transmitter on air) in the fast automatic mode for example.

If no numerical values are stated when entering test parameters, the CMT interrupts the measurement at the corresponding point, requests the user on the alphanumeric display to enter the value and continues the measurement after entry of the value. Thus it is easy to carry out measurements on transceivers of the same

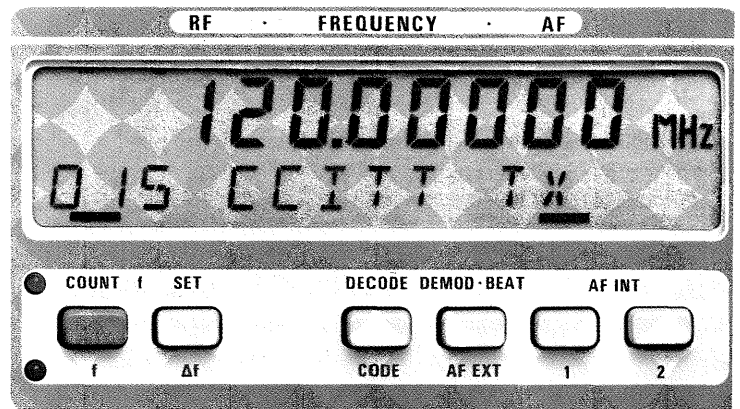

FIG 11 Indication of sequence steps on alphanumeric display while entering automatic measurements.



FIG 12 Transfer Memory CM-Z1, accessory for Radiocommunication Tester CMT with optional autorun control/printer interface.

spinwheel. A printer with **Centronics interface** – eg PUD 2 or PUD 3 from Rohde & Schwarz – **directly** connected to the CMT logs a complete test sequence in the form of explanatory text with extensive data representation and marking of measured values outside the given tolerances. The possibility of erasing unnecessary test steps or including new ones (also anywhere in existing sequences) matches the convenience of an external process controller.

In autorun mode the start is triggered by pressing a key and indicated by a LED. The CMT then executes all test steps in the entry sequence, compares each measured value with the preset limits and indicates a correct value by a green LED (measured value within tolerance) or an error by a red LED (measured value outside tolerance). In wait loops the CMT waits for a defined time before the next measurement in order to avoid wrong interpretation

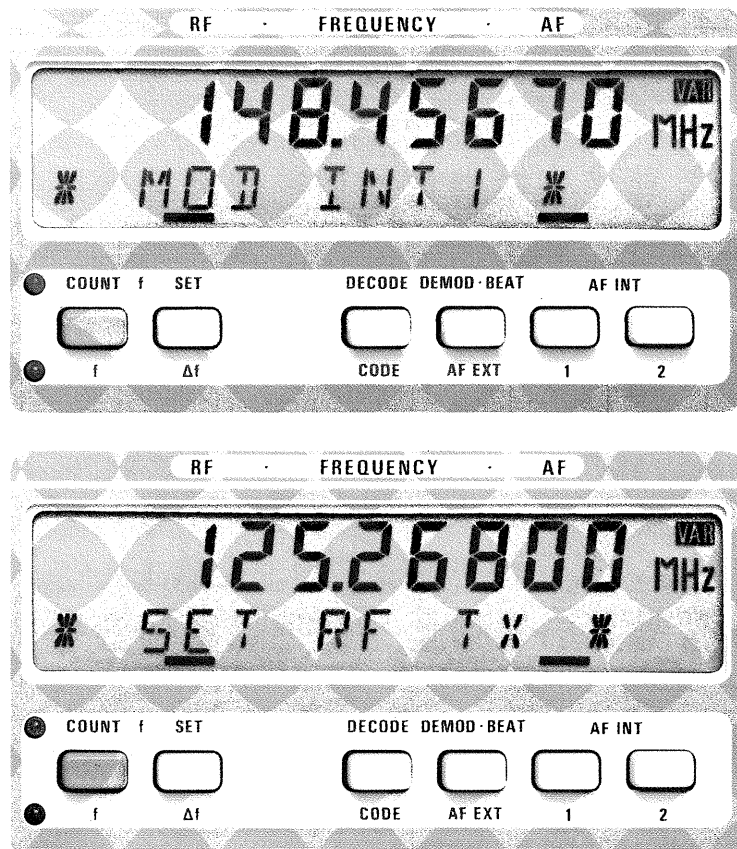

because of too early measurement. In the case of inserted continuous stops the CMT interrupts the automatic run, indicates this by a LED and requests the user by a remark on the alphanumeric display to take action (FIG 13). The CMT subsequently continues execution of the test sequence upon pressing of the **CONT** key. In addition the run can be interrupted at any time by the **STOP** key and continued with the **CONT** key. At the end of the test the complete evaluation provides a rapid summary by flashing of the red LED (at least one measured value outside tolerance) or the green LED (all measured values within tolerance).

Selftest

The selftest facilities of the CMT extend far beyond the usual RAM and ROM tests and include the **functions and accuracy** of almost all the measuring devices. For example, the signal paths for the AF-voltmeter input signal or the demodulated signal (including all functional units such as amplifier, switchover unit, filter, rectifier, A/D converter) are checked for offset voltages and gain errors cyclically, automatically and unseen by the user. The values determined are used to **generate correction factors** for the measured-value display.

The frequency modulation of the RF synthesizer is measured in a **calibration routine** by the internal, highly accurate **digital FM demodulator** throughout the frequency range. The values determined are automatically incorporated as correction factors in the FM setting. At the same time the actual functions of frequency synthesis, FM demodulator and all important control-loop voltages of the RF synthesizer are checked. A highly accurate **calibration modulator** is installed for testing the AM demodulator that detects deviations and automatically takes them into account in the measured-value display.

The selftest and self-calibration devices integrated in the CMT have been implemented in this form for the **first time** in a radiotelephone test assembly. This results in decisive advantages, especially in the following areas:

Service

- identification of faulty subunits
- module replacement without readjustment
- little stocking of modules required
- hardly any additional measuring instruments required

Maintenance

- long maintenance intervals or none at all
- hardly any additional measuring devices required when fitted with corresponding options
- readjustment only necessary on very few occasions as result of autocalibration

FIG 13 Operator prompting on alphanumeric displays during automatic test sequence.

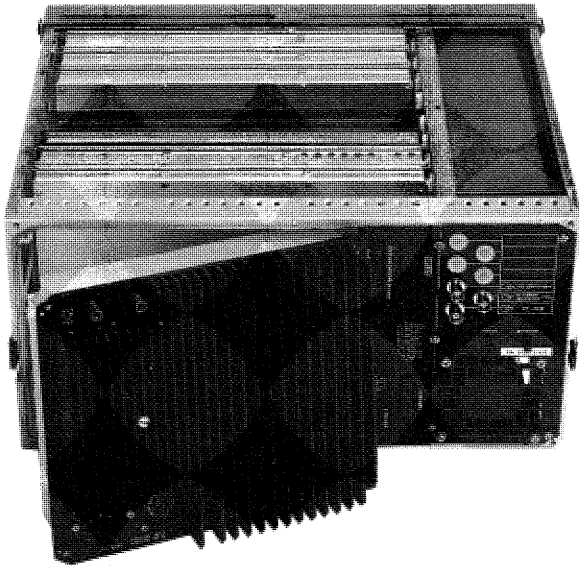

FIG 14 Easy service and maintenance design of CMT. Few and large plug-in cards are connected via common motherboard and replaceable without readjustment. Power supply can be removed after loosening few screws and can even be loaded when dismantled for service purposes.

General application

- high accuracy under all operating conditions
- high longterm stability of all measuring devices
- avoidance of faulty measurements in event of partial failures

The autorun control is of equal importance for all areas. All measuring devices in the CMT can be checked using it and appropriate options in the **shortest possible time**. The complexity of the test and the deviations permissible for the upper and lower tolerance limits can be entered by the user. FIG 14 shows that the CMT is designed for easy servicing.

CMT functional groups and measurement facilities

RF synthesizer

The RF synthesizer in the CMT provides output signals in the continuous frequency range from 0.1 to 1000 MHz with high accuracy in the **wide level range** from -137 to $+13$ dBm and **low spurious FM**. CW, FM, AM or ϕ M can be selected. An additional, electronic fine level variation over 20 dB (without carrier interrupt) enables exact determination of the squelch response threshold and hysteresis (FIG 15). The level can be entered in μ V, mV, dB μ V or dBm; **conversion of units** is also possible. A separate key is available for switching the carrier off.

Universal modulation capabilities are offered by the built-in modulation synthesizer: internal modulation, external modulation or a combination of both. If there are external modulation signals with unknown level, the CMT itself calibrates the modulation.

AF synthesizer

The AF synthesizer as a modulation generator provides crystal-controlled, highly accurate signals with low inherent distortion in the frequency range from 20 Hz to 30 kHz for internal modulation of the RF synthesizer and for modulation of the connected transceiver (FIG 16). To this end the output level can also be matched to highly sensitive microphone inputs as a result of its low internal impedance, fine resolution and high S/N ratio down to values of 10μ V. To enable fast testing of frequency response in transmitter and receiver tests, six additional **fixed frequencies** can be preprogrammed and recalled.

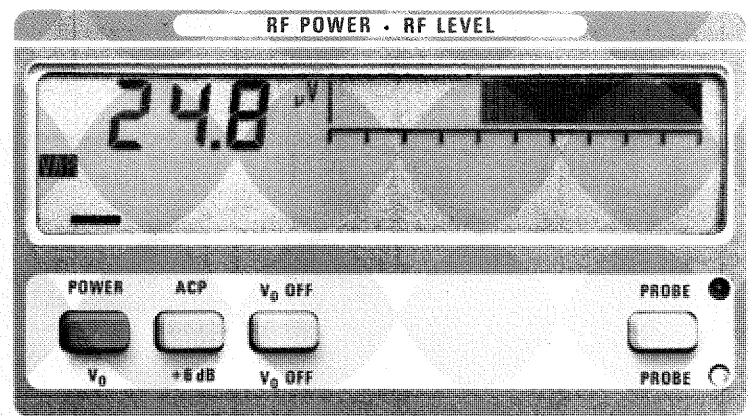
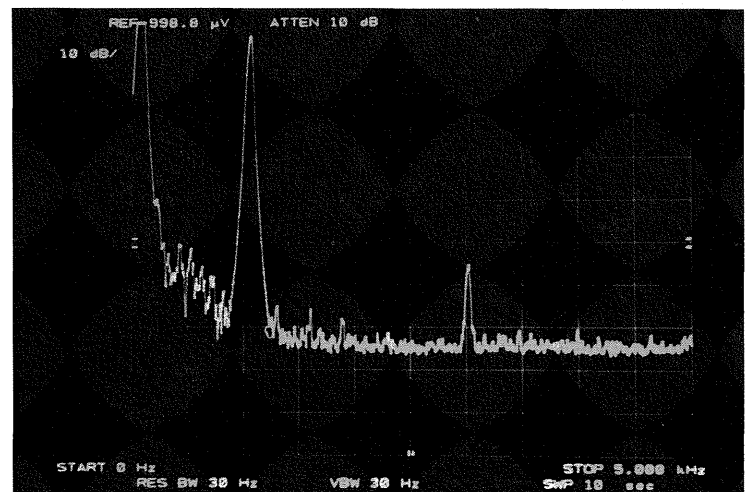

FIG 15 Display of selected RF output level with indicator for position of electronic fine tuning control (right).

A second AF synthesizer (option) allows the generation of two-tone signals with any frequencies as are required for **testing SSB transmitters** and also for the generation of **DTMF signals** or simultaneous pilot and wanted modulation (FIG 17).

FIG 16 High spectral purity of modulation-generator output signal at low output voltages (here 1 mV) as criterion for possibility of S/N-ratio and distortion measurements on transceivers with sensitive microphone input.



Demodulators

The AM, FM and ϕ M demodulators integrated in the CMT are automatically tuned to the RF signal to be measured with the aid of cyclic frequency measurements; they can also be preset to reduce transients to an absolute minimum. They measure either the positive (+PK), negative (-PK), average (\pm PK/2) or maximum modulation (whichever is the greater value of +PK or -PK). The PK HOLD function allows measurement and display of even short-term, transient peak modulation.

Spurious modulation or S/N ratio is measured automatically by switching to true RMS measurement at a meaningful threshold. It is also possible to carry out a peak or RMS measurement on its own, the type of weighting being shown on the display.

A switchable deemphasis of 750 μ s is provided for special measurements in FM mode. A highpass can be switched into circuit to suppress pilot tones so that only the useful modulation signal can be measured for all types of modulation. The switch-selectable CCITT filter allows comparative noise, SINAD and S/N measurements in line with standards worldwide (FIG 18).

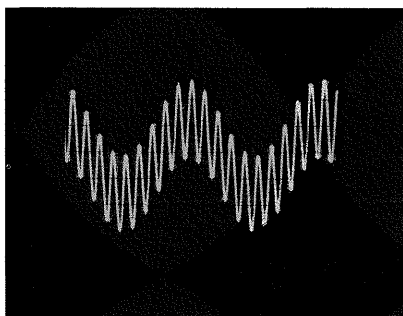

FIG 17 Two-tone modulation signal of CMT with separate setting of modulation and frequency for useful signal and pilot tone.

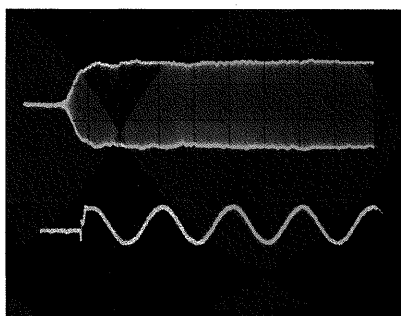

FIG 18 Extremely short settling time of deviation meter. Top: time curve of fed-in RF signal. Bottom: time curve of demodulated signal.

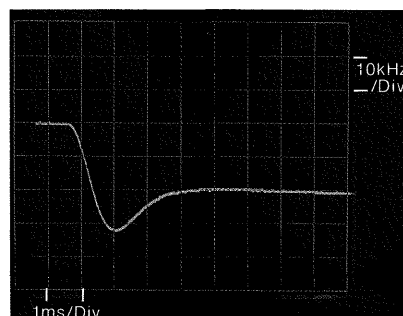

FIG 19 Voltage characteristic at demodulated signal output of CMT as measure of frequency settling of radio when changing channel.

The CMT has a second input with high sensitivity for off-air measurements via an antenna or for non-contact measurements on high-impedance or weak signals using probes. The CMT can therefore be used for all measurements on IF amplifiers, mixers and oscillators.

The demodulated signal shown on the LCD is also available at a socket on the front panel. The output is DC-coupled and has a high dynamic range corresponding to a deviation of ± 125 kHz. In conjunction with a trigger output on the rear panel (TTL High for RF signal fed into CMT), simple measurement of transmitter transients is possible with an external storage oscilloscope or a high-speed system voltmeter (FIG 19).

Distortion meter, SINAD meter

These two measuring facilities determine the distortion or SINAD value of the demodulated signal or the signal applied to the AF voltmeter. A fast measuring rate, with and without CCITT weighting, is used for optimum adjustments. A highpass can be switched into the demodulator circuit and efficiently suppresses subaudio

pilot tones to avoid wrong results. The CMT model 54 (with integrated oscilloscope) permits noise and distortion products to be directly displayed on the screen by suppressing the useful signal, thus enabling more detailed analyses.

If any SINAD value is entered on the keypad, the CMT automatically varies the RF level until the entered value is obtained. The determined RF level characterizes the sensitivity of the transceiver and is indicated directly.

AF voltmeter

Without loading the source the AF voltmeter measures AF signals from 100 μ V to 30 V either broadband or with switch-selected CCITT weighting. The lower cutoff frequency of the true RMS meter can be switch-selected to ensure optimum measuring rates and suppression of pulse noise.

S/N meter

The S/N meter determines the signal/noise ratio directly in dB at the AF output of a transceiver by cyclically switching the modulation on and off. The same measurement can also be made with the transceiver in transmitter mode; in this case the level of the modulation generator is switched cyclically.

CCITT weighting or cutoff frequencies can also be switched-selected.

The sensitivity of a receiver is determined by the CMT by way of the RF level for any preset S/N values in the same way as with SINAD measurement.

RF counter

The RF counter operates independently of the internal RF synthesizer as a direct frequency counter. It is therefore suitable for measurements on transceivers or repeater stations whose transmit and receive frequencies are in different bands and for measur-

FIG 20 Non-contact and reaction-free frequency measurement on oscillators using probe connected to sensitive RF input.

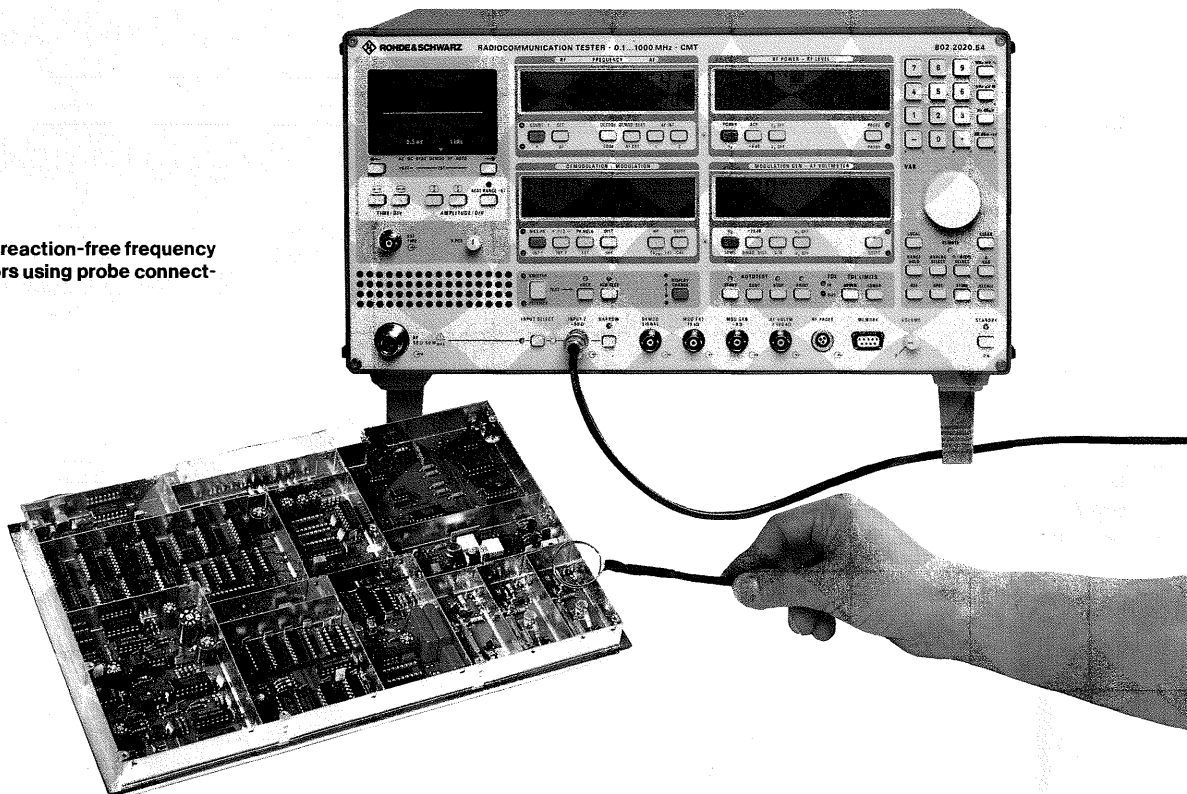

ing mixture products (eg IF signals) generated with the aid of the built-in RF synthesizer. The resolution of 10 Hz can be switched over to 1 Hz for special applications. The second, sensitive input is used for determining the frequency of low-level signals or signals from high-impedance sources (mixer oscillators, IF signals, converters, etc) (FIG 20).

AF counter, frequency-error meter

The AF counter measures the frequency either of the signal demodulated by the CMT or of the AF-voltmeter input signal. For frequencies up to 4 kHz it automatically measures the periods with resolution of 0.1 Hz (with high measuring rate for fast and simple frequency adjustment). Resolution is 1 Hz for frequencies above 4 kHz (gating-time counter). During beat-frequency measurement the frequency difference from any nominal frequency that can be preset is indicated and measured values are output at a fast rate for optimum adjustment of mixer oscillators, oscillator crystals, etc. The counter is extremely insensitive to superimposed noise so accurate determination of frequency is ensured for off-air measurements. To support this the counter can be switched to pure gating-time measurement with a high degree of freedom from noise.

RF power meter

The RF power meter measures transmitter power from 5 mW to 50 W (useful from 1 mW) at a fast rate. It is therefore suitable for everything from a low-power, cordless telephone through to a high-power transmitter output stage. For measurement of even higher powers the attenuation of external power attenuators can be entered and the CMT then automatically corrects all test para-

meters and measured values by this attenuation factor. Two-dimensional correction of systematic errors ensures the high accuracy of the power meter over the entire dynamic and frequency ranges.

Selective-call decoder

The integrated selective-call decoder uses continuous, fast period measurements and a special evaluation algorithm to determine selective calls of all standards and of three user-defined standards. The selective-call tones including special tones A to E are indicated directly on the alphanumeric display (FIG 21), inadmissible frequency variations and excessively long intervals being marked correspondingly. The bandwidth to be evaluated can be preset for tolerance investigations.

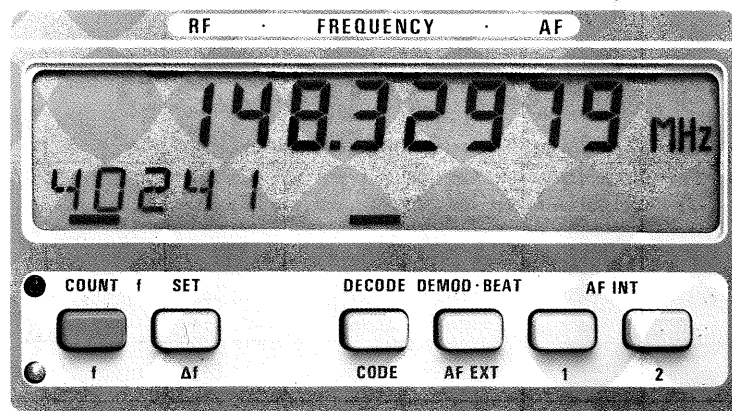

FIG 21 Indication of selective call decoded by CMT on alphanumeric display.

Selective-call encoder

The integrated selective-call encoder generates all major standards including Europaging and three user-defined standards (FIG 22). The range of application can be extended by numerous variation possibilities such as extended first tone, switch-selectable automatic repeat, adjustable intervals, etc. The selected standard and the parameter variations (eg frequency change) are clearly indicated on the alphanumeric display.

Off-air measurements

An additional input of maximum sensitivity ($5\mu\text{V}$) with a switch-selectable narrowband IF filter is available for determining modulation and frequency variations of remote transmitters via antennas or for measuring signals with an extremely low level (FIG 23). This

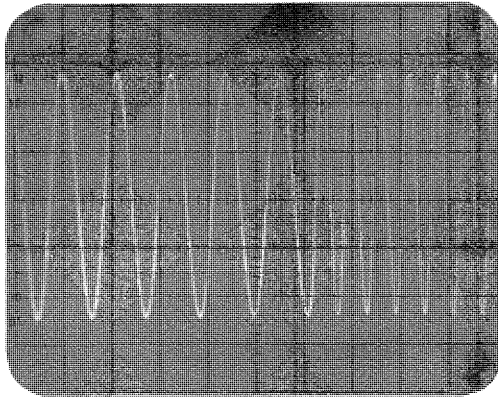

FIG 22 Details of selective call with phase continuity during frequency change.

FIG 23 High sensitivity of CMT makes it very suitable for off-air measurements with connected antenna.

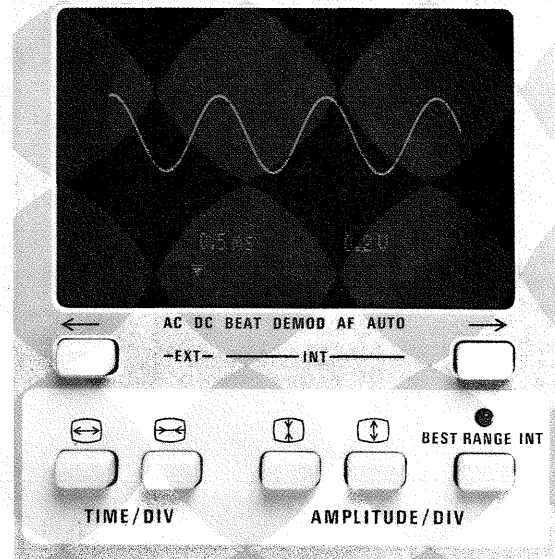
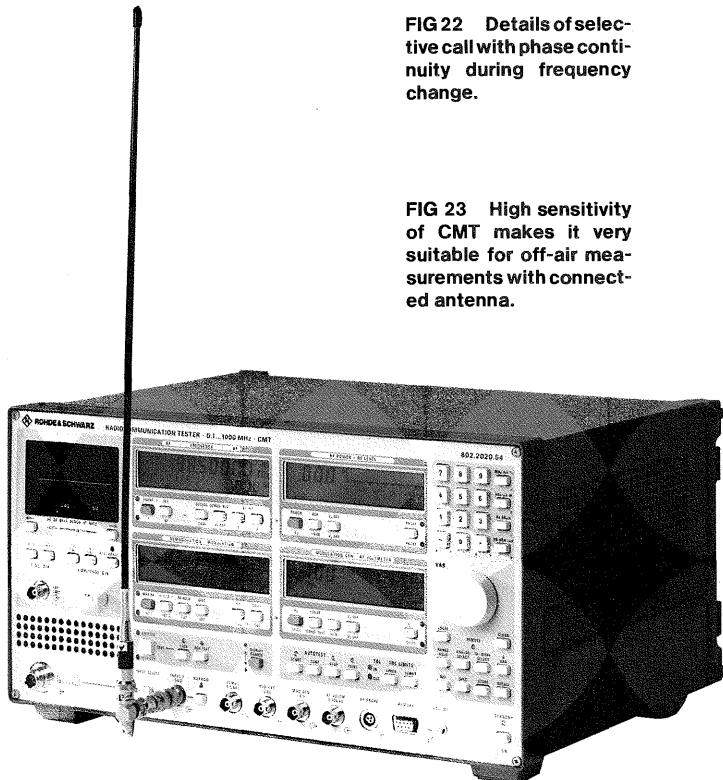

FIG 24 Oscilloscope (CMT model 54) with keypad and superimposed scale.

input enables the essential characteristics of the transmitter to be checked by a fast functional test without having to remove the transceiver or adapt it to the test assembly. Receiver characteristics can be checked in a similar way by connecting an antenna to the RF-synthesizer output.

Audio monitoring

The built-in loudspeaker reproduces all AF signals – demodulated signal, AF-voltmeter input signal and beat frequency – with adjustable volume. Sensitive dynamic compression prevents overdriving effects at high levels (loudspeaker output signal), enables detection of even very low signals (spurious FM), prevents major volume jumps when changing the operating mode and enables clear detection of level or modulation variations.

Oscilloscope

The CMT as model 54 is available with a built-in oscilloscope (FIG 24) and therefore provides an additional important monitoring and measuring facility matched to the particular needs of production testing and servicing.

The oscilloscope can operate in external mode in a conventional manner with probe. If the oscilloscope is driven by an internal source, the signal demodulated by the CMT in a transmitter test or the AF signal provided by the transceiver in a receiver test is automatically displayed on the screen with freely selectable time and amplitude resolutions. To allow correct signal evaluation the vertical scale is calibrated in V or mV for AF, in kHz or Hz for FM, in % for AM and in rad or mrad for ϕM . The best range is selected by the CMT itself, either once or continually by a keystroke, so that readjustment is unnecessary when varying test parameters or switching from transmitter to receiver test.

The beat frequency (offset of transmit frequency) can also be displayed as well as the noise and distortion components determined by the distortion and SINAD meter by suppression of the useful signal. This last facility indicates the causes of poor SINAD or distortion values (noise, discrete noise products, oscillations, d_2 , d_3 , etc), thus providing information for troubleshooting.

2nd AF synthesizer/DTMF generator

A second AF synthesizer (option) with the same properties as the AF synthesizer fitted as standard in the CMT enables universal

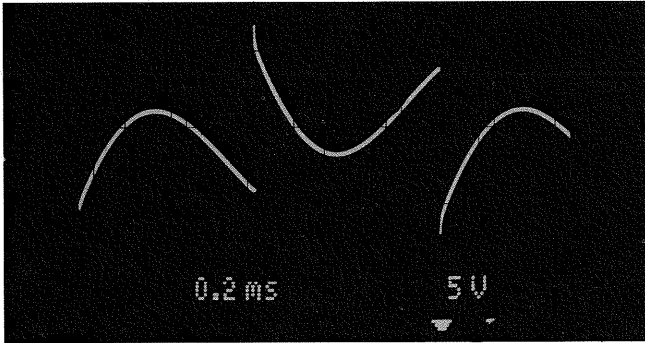

FIG 25 Noise products as cause of poor SINAD and distortion values, displayed on oscilloscope screen.

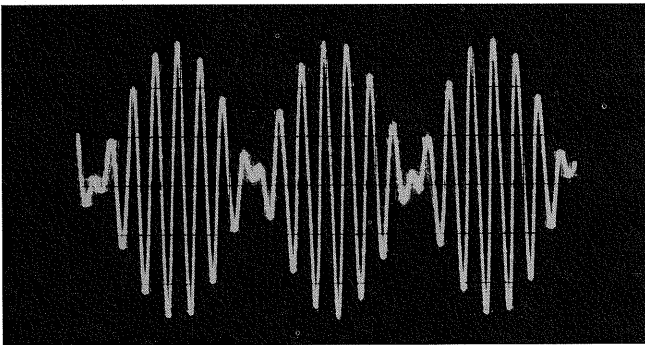

FIG 26 Details of DTMF signal generated by CMT.

two-tone modulation with separately adjustable modulation depth or deviation for **simultaneous transmission of useful and pilot tone modulation** or for an SSB transmitter test. In addition, **DTMF signals** (FIG 26) can be generated for testing touch-tone radiotelephones and their modules (eg decoders). Tolerance examinations are possible by varying the frequency offset, interval and tone durations within wide limits. Any two-tone standard can be preset for special applications. All necessary keys (0 to 9, *, #, A to F) are integrated on the keyboard of the CMT as **single keys** for fast input.

DTMF decoder

The optional DTMF decoder decodes two-tone signals from a touch-tone transceiver, checks them for agreement with the corresponding standard and displays them (FIG 27). As with the selective-call decoder deviations, for example violation of the frequency tolerance, are exactly determined and displayed.

RF millivoltmeter

The RF millivoltmeter option allows connection of **high-impedance probes** for measurement of RF voltages in amplifiers, demodulators, mixer oscillators, etc. It also enables the use of insertion units for **match-terminated measurement** of the output levels of modules or subunits in development, production and servicing for troubleshooting, calibration and maintenance. A wide choice of measuring heads and insertion units is available for **frequencies from 10 kHz to 1 GHz and voltages from 1 mV to 100 V**.

Adjacent-channel power meter

The adjacent-channel power meter (option) determines either the ratio of the power transmitted by the transceiver in the upper and lower, first or second adjacent channel in dB, referred to the useful-channel power, or the corresponding power in nW, μ W or mW. Double conversion using oscillators with particularly high spectral purity results in a **wide dynamic range of 80 dB** for measurements in radiotelephone bands. For cordless telephones (900-MHz band) the measurement limit of approx. 1 nW is far below the required 50 nW. Like all measuring facilities for transmitter testing, the adjacent-channel power meter can be used via the high-sensitivity input. In addition it can be used as a **selective voltmeter**, eg for measuring spurious signals.

OEXO reference oscillator

A heated, temperature-controlled crystal oscillator with aging of only 1×10^{-9} /day and **temperature effect of $2 \times 10^{-9}/^{\circ}\text{C}$** is available to satisfy highest demands on frequency accuracy of the RF synthesizer and RF counter. In standby mode the crystal oscillator is kept at rated temperature, thus ensuring **fast availability**.

FIG 27 Indication of touch-tone call number on alphanumeric display.

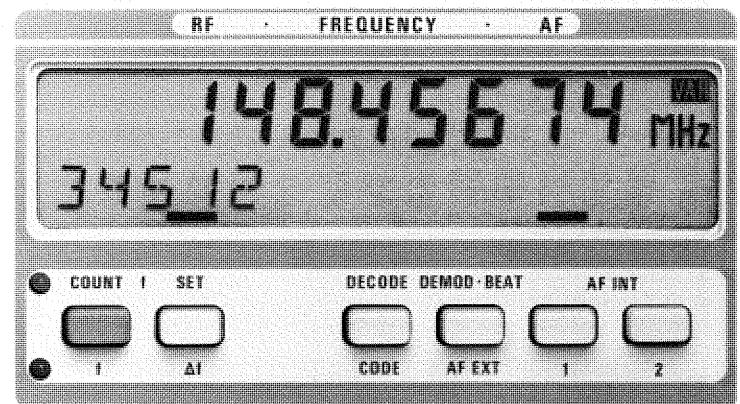

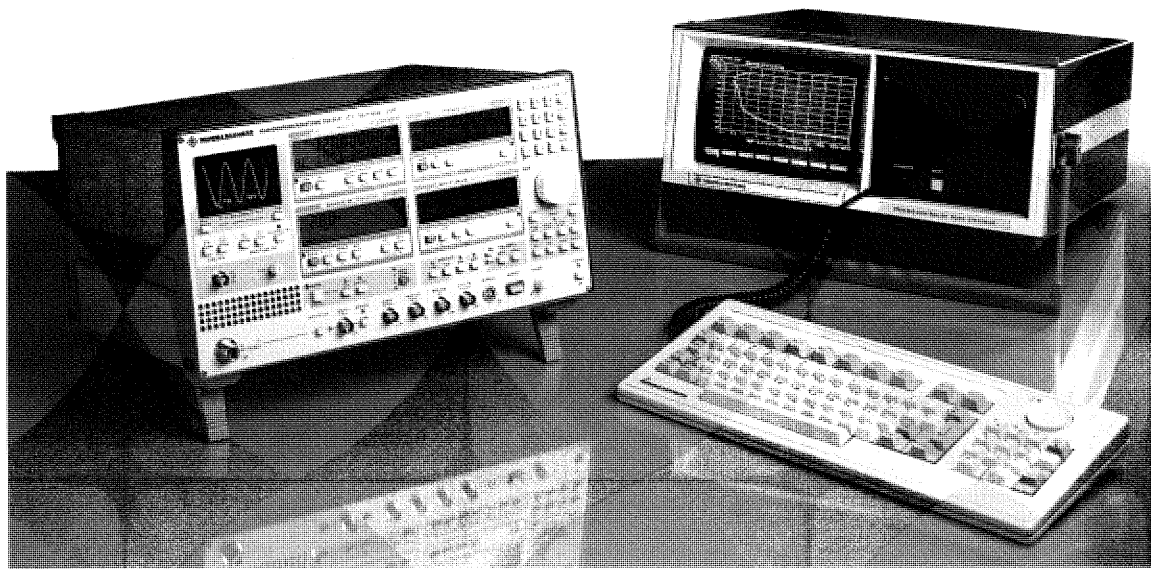

FIG 28 CMT with Process Controller PCA 5 as computer-controlled test assembly.

Duplex modulation meter

The duplex modulation meter option enables the FM, AM and ϕ M meters to operate independently of the built-in RF synthesizer. It covers the entire RF range and is therefore suitable for transceivers whose transmit and receive frequencies are in different bands.

The deviation measurement range, modulation-frequency range and low spurious FM are identical with those of the basic unit so that all transmitter measurements can be carried out without any restrictions. This is particularly interesting for measurements on repeater stations and mobile phones of modern cellular-radio networks since these can often only be held in transmit mode by the presence of a receive signal. Transmitter measurements should therefore be carried out with the duplex modulation meter.

IEC/IEEE bus

Using the IEC/IEEE-bus option the CMT can be operated in conjunction with a process controller – eg PUC or PCA from Rohde & Schwarz – to form a **fully automatic test assembly** (FIG 28). Simple IEC/IEEE-bus commands as well as the use of internal, automatic test routines ensure **easy and fast generation of test runs**.

Eight remotely controlled relays enable **automatic setting of a transceiver** to the desired test mode, control of additional devices that cannot be remotely controlled or any necessary switchover of testpoints.

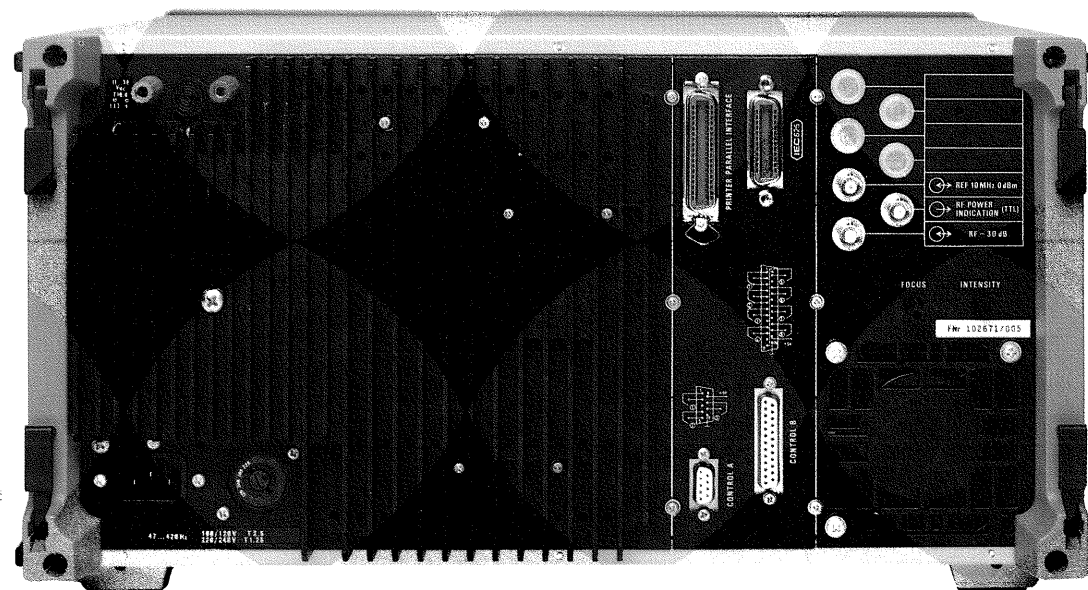

FIG 29 Connectors on rear panel of CMT.

Autorun control/printer interface

The autorun control facility (option) enables test sequences to be written, executed and stored in a **nonvolatile memory** as well as data logging on a printer **without** the use of an external process controller. FIG 29 shows the connections on the rear panel of the CMT.

Two-signal measurements

For receiver measurements requiring two RF generators the CMT is provided with an additional RF input/output on the rear panel isolated by 30 dB from the RF input/output on the front panel. A second RF signal can be applied here. **All two-signal measurements such as adjacent-channel selectivity, interchannel modulation, crossmodulation** can thus be carried out simply without requiring additional devices (attenuators, distributors, etc) (FIG 30).

For highest demands with critical two-signal measurements it is recommendable to use an extremely low-noise source as the second RF generator with low spurious content. Particularly suitable models are **SMPC or SMPD** from Rohde & Schwarz. The latter model with its wide frequency range enables measurement of spurious responses to more than 2 GHz.

Michael Vohrer

CONDENSED DATA RADIOCOMMUNICATION TESTER CMT

Generator section

RF synthesizer	0.1 to 1000 MHz, -137 to +13 dBm
Modulation	AM, FM, Φ M
Two modulation generators	20 Hz to 30 kHz, 10 μ V to 5 V
Selective-call encoder	according to 7 standards or programmable
Two-tone generator	according to DTMF or programmable

Measurement section

Frequency meter	
RF	0.4 to 1000 MHz
AF	20 Hz to 500 kHz
RF power meter	5 mW to 50 W
Modulation meter	MAX. PK, + PK, - PK, \pm PK/2, PK HOLD, RMS
Duplex modulation meter	same as modulation meter
AF voltmeter	0.1 mV to 30 V
Distortion meter	0.1 to 50%
SINAD meter	1 to 46 dB
S/N meter	1 to 46 dB
Oscilloscope	DC/AC to 100 kHz for internal and external signals
Selective-call decoder	according to 7 standards or programmable
Two-tone decoder	according to DTMF
Adjacent-channel power meter	20 to 80 dB
RF millivoltmeter	10 kHz to 1 GHz, 1 mV to 100 V
Filters	CCITT, 300-Hz highpass
Off-air measurements	sensitivity approx. 5 μ V

Control section

Remote control/control interface	IEC 625-1 (IEEE 488), 8 relays
Autorun control/printer interface	20 to 100 complete test sequences, 3 relays, parallel interface
Ordering number	802.2020...

FIG 30 Simple test setup for all two-signal measurements.

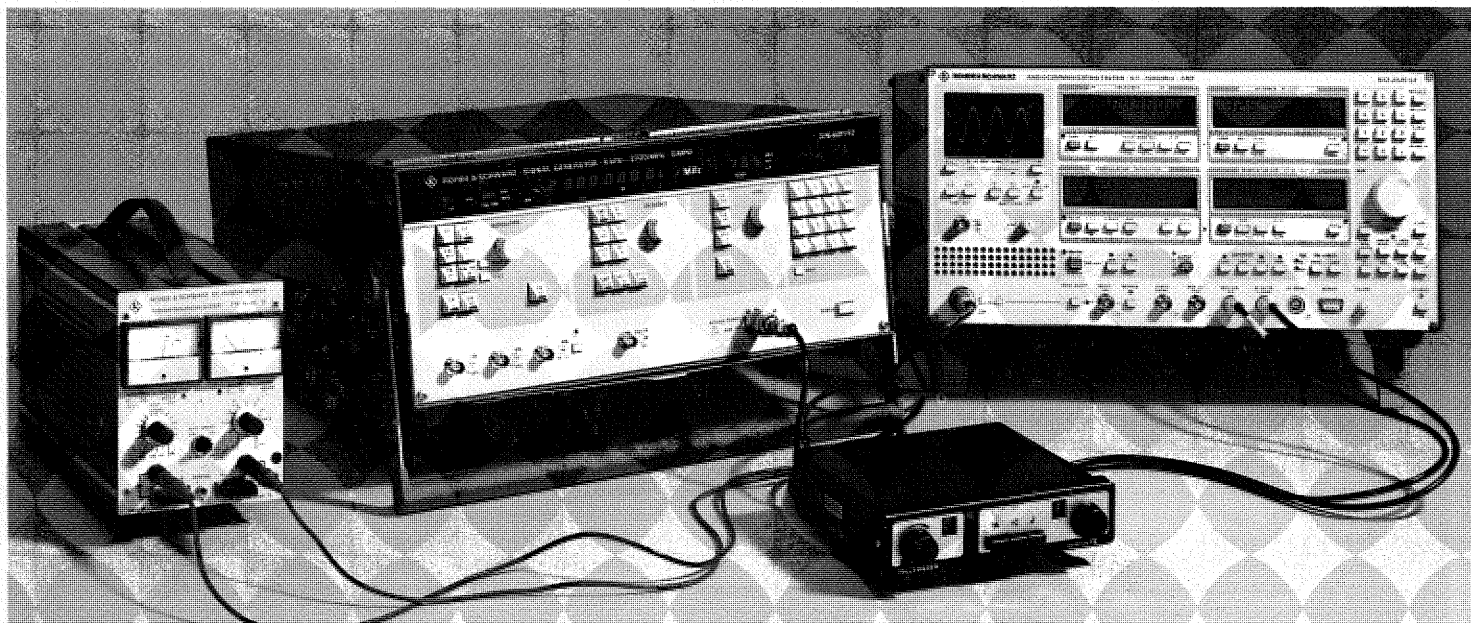

The Mobile Testers SMFP 2 and SMFS 2 for manual or automatic operation incorporate ultramodern transceiver measurement features for all applications associated with servicing, development, quality assurance and production. The system can be matched to special measuring problems in an economical manner by using meaningful options. With new measuring devices and a full-duplex deviation meter, both test sets satisfy increased measuring demands, especially with mobile stations of modern cellular-radio networks, and are obsolescence-proof to a high degree.

Duplex radiotelephone test sets Mobile Testers SMFP 2 and SMFS 2

FIG 1 Worldwide use of several thousand radiotelephone test sets SMFP/S 2 in development, production, servicing, licensing and acceptance indicates their quality and universal application possibilities.

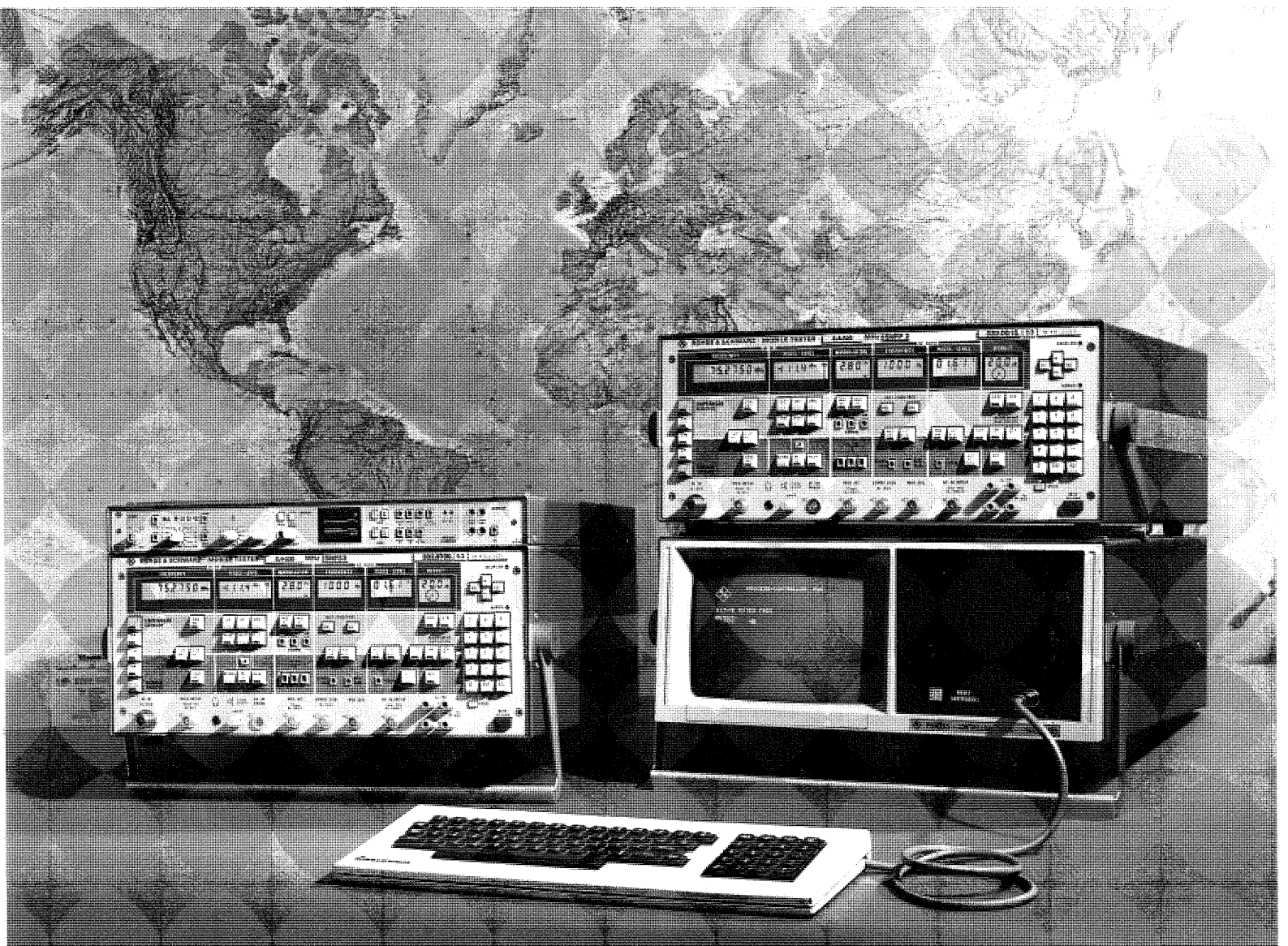

The Mobile Testers SMFP 2 and SMFS 2 are test sets for the entire range of FM, ϕ M and AM transceiver measurements (FIG 1). Manual and automatic operation, mobile and stationary use, universal measuring capabilities and high measuring speed together with excellent technical performance are just some of the advantages of these versatile systems for use in development, test departments, final testing, approval, acceptance, quality assurance and servicing. As a result of options for extending test facilities, numerous special functions for particular settings and measurements and a nonvolatile memory for **storing complete instrument settings**, frequency information and special functions, no limits are set to the applications. The design of the instruments takes into account signalling methods presently known and expected in the future. In particular, the addition of the Radiocode Test Set SCUD for the generation and analysis of selective-calling and radio-data signals ensures their use for **many years to come**. The SMFP 2 and SCUD are eminently suitable for the **simulation of fixed stations** and for measurements on mobile stations in the **cellular-radio networks AMPS, TACS and NMT**.

The SMFP 2 and SMFS 2 embody the same basic design and offer almost the same measurement capabilities (see box on page 35). Whereas the SMFS 2 is designed for manual and semi-automatic operation, with the SMFP 2 all test parameters and sequences including all special functions can additionally be called up from a process controller. Fast generation of test procedures is possible using simple IEC/IEEE-bus commands and the basic software packages which are available.

Operation

The controls of the SMFP 2 and SMFS 2 are arranged in different sections of different colours according to the measurement mode (transmitter or receiver test), instrument setting or parameter to be measured. This **logical organization of the front panel** ensures errorfree operation without training and **fast access to automatic routines**. Moreover, illuminated keys for data setting and the indication of measurements in progress prevent erroneous interpretation of results. The choice between manual operation and calling up automatic measurement routines ensures versatile use of the test set on the one hand and speedy and errorfree measurement of repetitive standard values on the other.

Six LCDs simultaneously indicate most of the test parameters and results with unit. This eliminates reading errors and enables the interdependence of individual parameters to be determined easily.

In addition to the display as an absolute value, relative values are possible in dB referred to the current measured value, or to a reference value entered via the keyboard, for example for frequency-response measurements.

Parameters are entered directly with the keyboard or can be modified quasicontinuously (FIG 2). Two keys designated with arrows shift a marker until it indicates the digit to be varied. Two other keys (+ and -) then permit this digit to be varied in steps or, if kept depressed, in a fast sequence. Since the carry of the digit varied is also considered automatically, the test set offers the user, besides digital entry via the keyboard, quasianalog tuning with the **advantage of selectable resolution**.

The two main modes of operation – transmitter test and receiver test – are engaged automatically according to the RF power arriving from the transceiver. The switchover can also be performed or inhibited by pressing a key so that parts of each test may be combined. For example, the SINAD ratio of a receiver can be checked during a transmitter test in order to determine useful-signal transfer in duplex operation.

On switching from transmitter to receiver test, the frequency of the RF generator is set automatically either

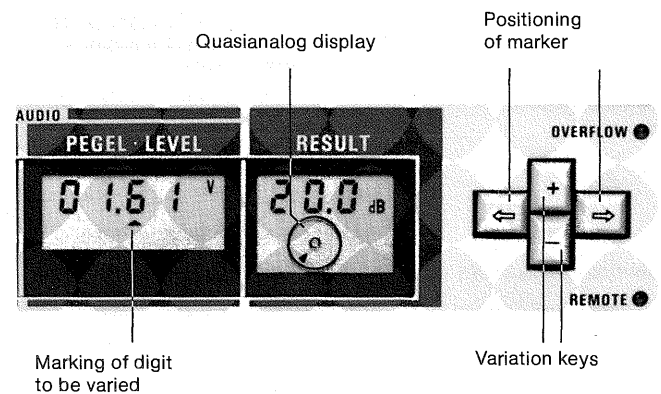

FIG 2 Keys on SMFP 2 and SMFS 2 for varying any desired digit of level and frequency of RF and AF generators as well as modulation.

- to a frequency entered on the keyboard,
- to the transmit frequency of the transceiver measured or
- to the duplex pair frequency in the upper or lower band.

When the transmit frequency of a transceiver is entered via the keyboard and the deviation meter is on, the mobile tester switches to transmitter test within a very short time so that **transceivers that send a reply call** can be measured. If the **duplex deviation meter** is fitted, the demodulated transmitter signal is present as soon as the transmitter is switched on.

All test parameters are stored when the operating mode is switched over and – provided the operator does not alter them in the meantime – reset automatically upon recall so that no new entries are required even with repeated switchover.

Automatic settings and automatic routines in the SMFP 2 and SMFS 2, assigned to particular modes for receiver and transmitter testing, spare the user the repetitive settings which are otherwise needed in day-to-day measurements. With the SMFP 2 these can also be called via the IEC/IEEE bus and enable very fast generation of routines together with the basic software (FIGs 3 and 4).

In conjunction with a controller the SMFP 2 forms a **fully automatic transceiver test assembly**. The control section in the SMFP 2 (option for SMFS 2) automatically sets the transceiver via control lines (3 x 4) programmable in BCD code and a relay matrix with eight relays – eg channel selection, transmitter/receiver switchover, squelch and loudspeaker on/off – as well as controlling non-IEC/IEEE-bus-compatible accessory equipment (FIG 5). An additional relay is coupled with the transmitter/receiver test switchover and can handle the switchover of the connected transceiver in automatic and in manual operation if required.

Setting	Function
Transmitter test	Measurement of frequency, power and modulation
Receiver test	Measurement of AF level
Transmitter/receiver test switchover	Automatic switchover by transmission with transceiver
Receiver test frequency	Use of transmit frequency as receiver test frequency (in case of duplex operation with + or - offset)
Fast deviation measurement	With transmit frequency preset, output of demodulated signal immediately upon transmitter switch-on
Acknowledgement signal test	Transient response time of deviation meter: zero with duplex deviation meter, < 70 ms after transmitter switch-on without duplex deviation meter
SINAD measurement	Setting of 1-kHz modulation frequency
Distortion measurement	Setting of appropriate AF value
Selective call	Automatic setting and evaluation of repeat tone; tone-sequence generation followed or not by useful modulation
External attenuators	Setting of parameters and display of results take into account external attenuators or cable attenuations

FIG 3 Summary of main automatic settings.

Use of the Process Controller PUC or PCA 5 with built-in floppy-disk drive is recommended to extend the instrument into a fully automatic transceiver test assembly, permitting rapid routine and data output (FIGs 6 and 7). A large screen provides good readability and a clear display of routines and measured data.

Routine	Function	Display
Sensitivity (SINAD or S/N)	Variation of RF level until entered SINAD or S/N ratio is reached	SINAD or S/N ratio and corresponding RF level
S/N ratio	Determination of S/N ratio of AF output signal (receiver test) or of demodulated signal (transmitter test) by cyclically switching modulation on and off	S/N ratio in dB
Squelch threshold and hysteresis	Determination by varying RF level	Hysteresis in dB and upper threshold
Frequency response	Measurement with instantaneous measured value or programmable value as reference	+ dB or - dB
6-dB bandwidth	Determination by variation of RF level and RF frequency	Bandwidth and centre-frequency error
Modulation sensitivity	Variation of modulation level until entered modulation is reached	Modulation and AF level
Adjacent-channel power	Determination of power in upper or lower adjacent channels	Relative in dB or absolute value in μW

FIG 4 Summary of main automatic test routines.

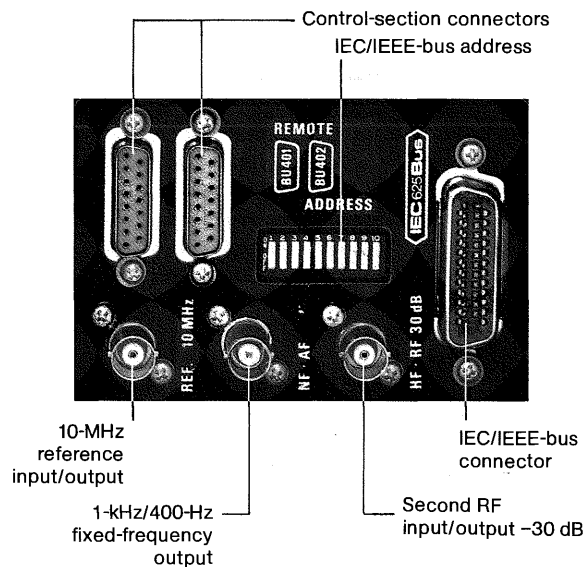

FIG 5 Connectors on rear panel of SMFP 2 and SMFS 2.

The computer-controlled, automatic transceiver test system SMFP 2 meets all requisites for rapid, exact and errorfree measurement. The preparation of the test sequences generally calls for pertinent knowledge and experience on the part of the user and requires a long time. In contrast, the use of Basic Software SMFP 2-K1 for PUC or Basic Software SMFP 2-K5 for PCA 5 provided by Rohde & Schwarz in the form of floppy disks for the process controllers has many advantages: generation of routines using the basic software involves nothing more than calling up the test routines, no programming knowledge being required (FIGs 8 and 9). In this way even complex sequences can be produced in a very short time.

Almost 100 routines contain the steps necessary for execution of the measurements: setting of the instrument, input and output of data, changing of settings on the test item and the computation of final results from several measured values. Further output routines display the results on the screen of the computer or generate a

FIG 6 Fully automatic transceiver test assembly with Mobile Tester SMFP 2, Process Controller PUC, Universal Printer PUD 2 or PUD 3 and programmable Power Supply NGPU.

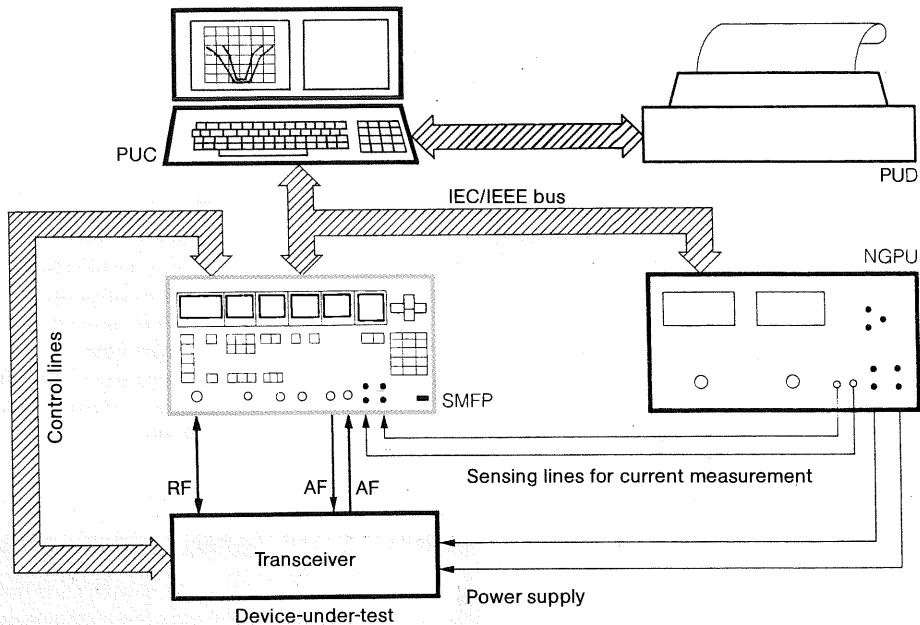

FIG 7 Mobile Tester SMFP 2 with Process Controller PUC.

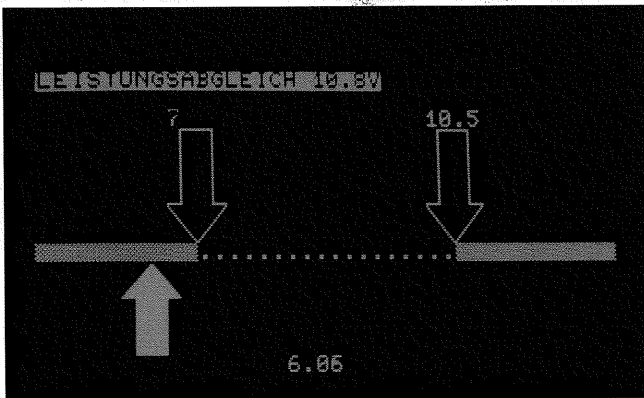
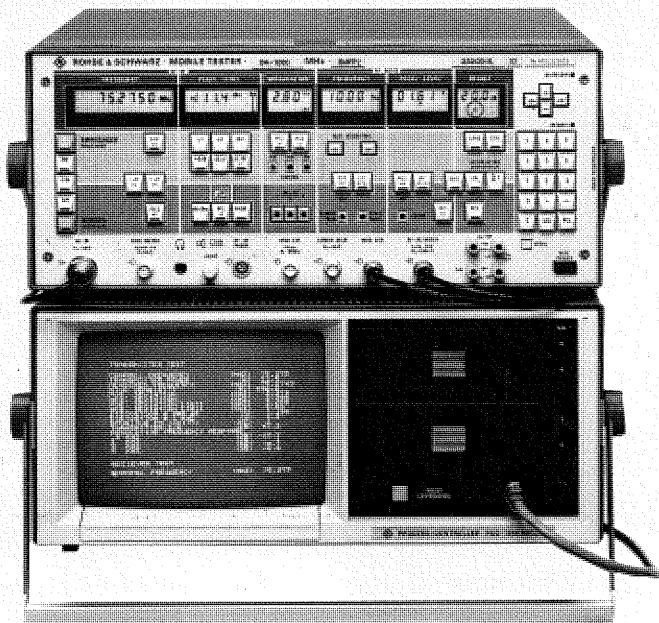

FIG 8 Example of display of transceiver adjustment on screen of Process Controller PUC (power adjustment with tolerance limits and actual value) using simple call of basic software routine.

FIG 9 Example of simple development of test routine using Basic Software SMFP 2-K1.

100 Y1\$="SMFP2"		Initialization
110 R=1:GOSUB9000		
120 Y=75.275	Receive frequency	Radio-telephone data
130 Y1=400	Channel number	
140 Y2=20	Channel spacing	
150 R=3:GOSUB9000		
160 Y=9.8	Duplex band spacing	Transmitter measurements
170 R=4:GOSUB9000	UB/LB	
180 Y=2	Modulation FM	
190 R=6:GOSUB9000		
200 Y=4	Maximum deviation	
210 R=7:GOSUB9000		
220 R=40:GOSUB9000	Transmitter test	Transmitter measurements
230 Y\$="TRANSMITTER ON"	Prompt on screen	
240 R=87:GOSUB9000		
250 R=41:GOSUB9000		
260 Y\$="RF POWER (W)"	Power measurement	Receiver measurements
270 Y1=9:Y2=11	Result on screen with tolerance monitoring	
280 R=91:GOSUB9000	Frequency-error measurement	
290 R=42:GOSUB9000		
300 Y\$="FREQUENCY ERROR (HZ)"		
310 Y1=-1500:Y2=1500		
320 R=91:GOSUB9000		
330 :		
340 :		
350 Y\$="TRANSMITTER OFF"	Prompt on screen	Receiver measurements
360 R=87:GOSUB9000		
370 R=62:GOSUB9000	Receiver test	
380 Y=100	RF level setting	
390 R=9:GOSUB9000		
400 Y=60	SINAD measurement	
410 R=65:GOSUB9000		
420 Y\$="SINAD @ 100UV RF (DB)"		
430 Y1=26:Y2=50		
440 R=91:GOSUB9000		

MOBILE TESTER

Blue: receiver measurement
Red: transmitter measurement
Italics: transmitter and receiver measurement

RF-level display
 RF-millivoltmeter display
 Level ($\mu\text{V}/\text{mV}/\text{dB}\mu\text{V}$)
 and fine adjustment,
 level with preset S/N
 or SINAD ratio
 Transmit power (W/dBm),
 adjacent-channel power
 ($\text{dB}/\mu\text{W}$)

Modulation display
 Modulation in kHz,
 % or rad
Pos./neg./average
 modulation in kHz,
 % or rad
 FM or ϕM from
 RF-meter input

RF-frequency display
 Test frequency,
 frequency error (with
 broadband measurement)
 Transmit frequency,
 nominal frequency (with
 adjacent-channel power
 measurement)
 Selective-call display
 External RF

Transfer of
 set RF frequency

Receiver test

Transceiver type,
 internal modulation,
 demodulation

Transmitter
 test

Steps in entered
 channel spacing

RF output,
 RF input

Frequency meter
 and deviation meter
 External RF (off-air measurement)

Transfer of
 set RF level
 and boosting
 by 6 dB

RF-signal
 blanking

Adjacent-
 channel
 power
 measurement

On/off,
 loudspeaker
 volume and
 headphones
 connection

Power
 meter

RF-millivoltmeter
 probe or
 insertion unit

Measurement with
 RF millivoltmeter

Modulation-
 signal
 input

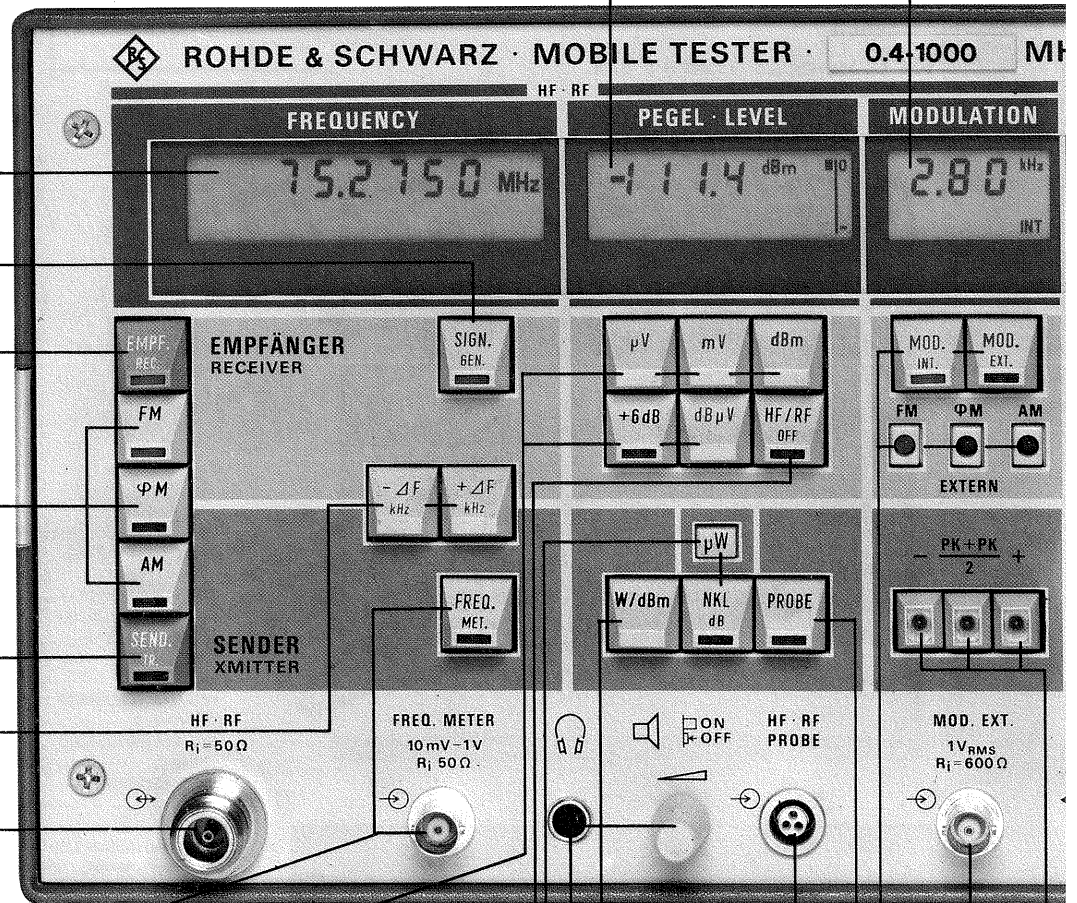

FRONT-PANEL DETAILS

AF display
Internal modulation frequency, bandwidth
AF-generator frequency, demodulated AF, beat frequency
External AF
AF-level display
AF level
Modulation-generator level
External currents and voltages

Digital display of result:
S/N or SINAD ratio, distortion
(AF-voltmeter input), AF level (in dB above reference value)
Analog (trend):
AF voltage, distortion, S/N or SINAD ratio

Digital:
distortion, S/N ratio
Analog (trend):
modulation, distortion, S/N ratio

Overflow display (incorrect input, range violation)

Variation of parameter selected by cursor

Cursor and setting

Sensitivity measurement (SINAD, S/N)

Parameter input, call of automatic routines and settings

Filters to CCITT and for distortion measurement

Call of special functions, routines and settings

DC ammeter and voltmeter

External AF and level meter

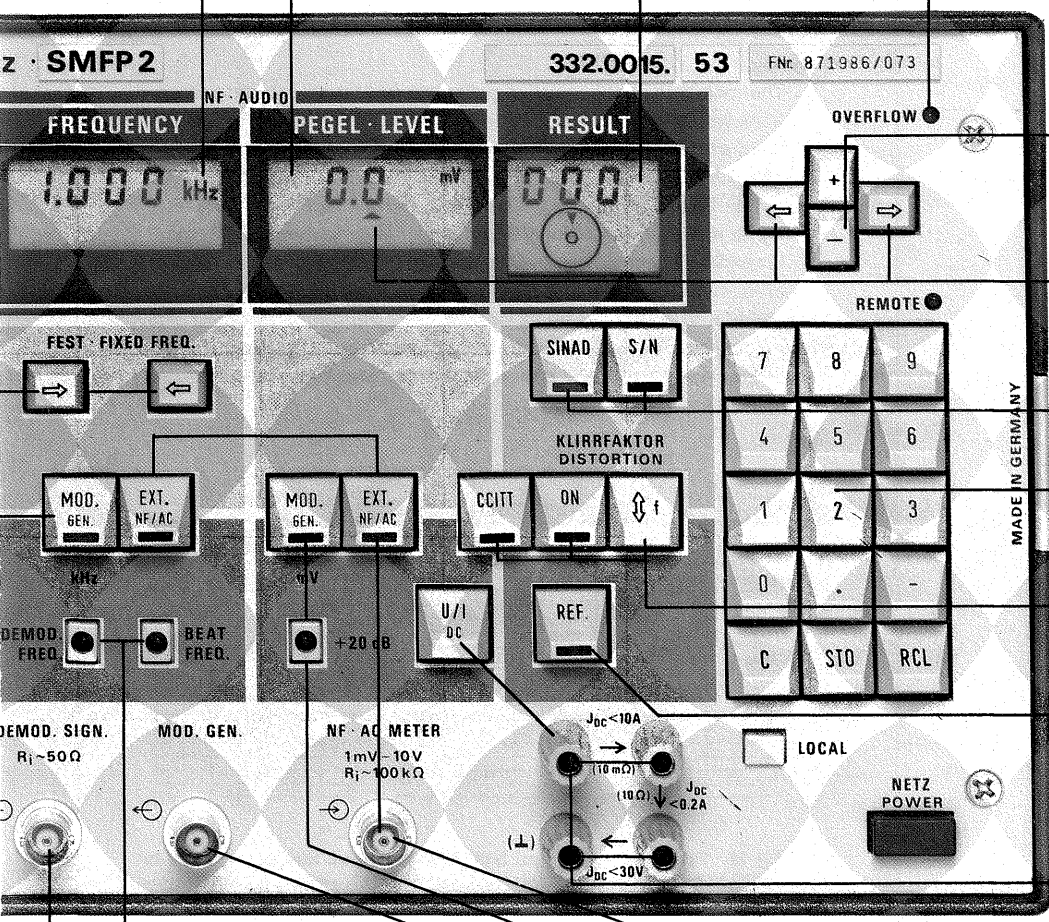

Modulation-generator output

Frequency meter for demodulated signal and beat

Demodulated-signal output

Modulation selection and transfer of entered data

Measurement of positive/negative/average modulation

Modulation frequency and transfer of fixed/entered frequencies

Transfer of modulation level and boosting by 20 dB

Routine No.	Routine
4 5 6 7	Input data Start RF = receive freq. Channel spacing Upper band/lower band spacing IF± Modulation: AM, FM, φ M Max. modulation
8 9 10 11 12 13 14 16 17 18 19 20 21 22 23 24	Instrument settings RF frequency RF level RF on/off RF level contin. variation ± 0.1 dB Mod. int. %, kHz or rad Mod. ext. Mod. int. on/off AF frequency setting AF level setting CCITT filter on/off Tone sequence to ZVEI or CCIR Control lines on/off BCD output setting Radio channel setting NGPU current-limit level setting NGPU voltage setting
27 28 30 31 32 33 34 35 36 37 39	Receiver and transmitter measurements AF frequency measurement ext. AF level measurement ext. Distortion 300 Hz, 500 Hz, 1 kHz in % RF voltage AF frequency response Tone-sequence generation Tone-sequence evaluation DC voltage measurement DC current measurement NGPU current measurement using SMFP 2 voltmeter Universal adjustment
40 41 42 43 44 47 48 49 51 53 54 55 56 58 59	Transmitter measurements Transmitter test RF power RF frequency error Pos. modulation Neg. modulation Spurious modulation Mod. sensitivity Mod. frequency response referred to 1 kHz with test-frequency input Mod. distortion 300 Hz, 500 Hz, 1 kHz S/N transmitter Freq. meter/RF input selection Frequency of demod. signal Beat frequency Adj.-channel power ratio in dB Adj.-channel power in μW
62 64 65 66 67 68 69 71 72 76 77 78	Receiver measurements Receiver test + sig. gen. frequency setting S/N measurement at 1 kHz SINAD measurement at 1 kHz Sensitivity for given S/N Sensitivity for given SINAD Quieting sensitivity 6-dB bandwidth + centre-frequency offset Modulation acceptance bandwidth Squelch upper and lower thresholds and hysteresis AF frequency response ref. to 1 kHz with test-frequency input Signal transfer in duplex operation Image-frequency rejection
86 87 88 89 90 91 92 93	Output Adjustment with analog display + call of routine Text (instruction on screen) Print out text on printer Print out result on printer Printer output with nominal/actual comparison Screen output with nominal/actual comparison Frequency chart Hardcopy
100	Internal error

FIG 10 All sequence steps for instrument settings, input and output of data and switchover of device under test required for measurements and calculation of results from several measurements are contained in almost 100 routines.

printout on a connected printer (eg PUD 2 or PUD 3). The results are also compared with preset nominal values and an indication is given if the tolerance limits are exceeded. The user can, of course, extend the basic software by adding **special routines**. This permits non-standard problems to be solved (FIG 10).

Features and measuring capabilities

The mobile testers consist of generator and measurement sections linked via a central microprocessor. The standard timebase used as a reference is a **temperature-controlled crystal oscillator** of highest accuracy, low aging and temperature dependence. This guarantees **extremely high frequency stability and accuracy** (FIG 11) for the RF synthesizer, AF synthesizer, RF counter and AF counter under all operating conditions – during mobile use with varying ambient temperatures as well as for rack mounting with a higher ambient temperature. An external 10-MHz frequency standard can be connected for even higher accuracy demands. To synchronize further instruments, the internal 10-MHz reference frequency is available at a separate socket.

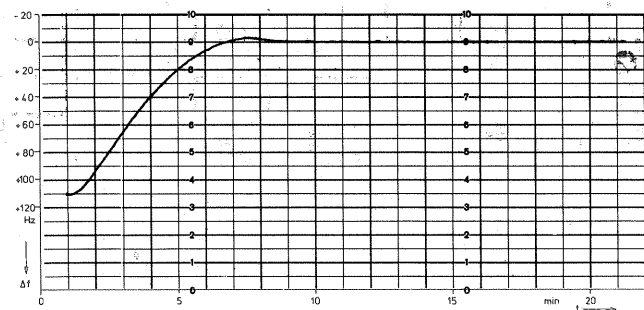

Fig 11 Fast availability and high stability of all measuring units in SMFP 2 and SMFS 2 are guaranteed by fast heating of temperature-controlled crystal oscillator.

Generator section

As the core of the generator section, the RF synthesizer provides crystal-stabilized and frequency-accurate signals from 400 kHz to 520 MHz, or with option SMFP-B2 up to 1 GHz, in the **wide output-level range** from -137 to +13 dBm and with **high resolution** of 0.1 dB. In addition to general parameter input via the keyboard and quasianalog tuning using variation keys, two additional **keys** +ΔF and -ΔF are available for varying the frequency by any preset step size.

Measuring and control devices in SMFP 2 and SMFS 2		Used for	
		receiver test	transmitter test
RF generator	0.4 to 520 MHz (to 1000 MHz with option)	●	
Modulation generator 1		●	●
– SMFP 2: continuous tuning plus 7 fixed frequencies			
– SMFS 2: 12 fixed frequencies (continuous tuning with option)			
Modulation generator 2	400 Hz/1 kHz, selectable		●
RF frequency meter	1 to 520 MHz (to 1000 MHz with option)		●
Power meter	to 30 W (to 60 W with option)		●
SINAD meter	switch-selected CCITT weighting filter	●	
S/N meter	switch-selected CCITT weighting filter	●	●
Modulation meter	for AM, FM and phase modulation		●
– with switch selection of positive, negative or average peak value			
– switch-selected CCITT weighting filter			●
Spurious-modulation meter			
– true RMS meter	switch-selected CCITT weighting filter		
AF voltmeter	switch-selected CCITT weighting filter	●	
Distortion meter	switch-selected CCITT weighting (additional)	●	●
AF meter	20 Hz to 1 MHz	●	●
Beat-frequency meter			●
– with loudspeaker and headphones connector			
DC voltmeter and ammeter		●	●
Adjacent-channel power meter (option)			●
Selective-call encoder	(option with SMFS 2)	●	
Selective-call decoder	(option)		●
RF millivoltmeter	(option)	●	●
Duplex deviation meter	(option)		●
Control device	for transceiver (optional with SMFS 2)	●	●
– 12 TTL control lines and relay matrix			
Aural monitoring	with loudspeaker and headphones	●	●
Analog display	(option)	●	●
– with oscilloscope and analog displays			

FIG 12 SMFP 2 and SMFS 2 output-level display combined with read-out of electronic, fine level variation with keys for entry and conversion of physical units.

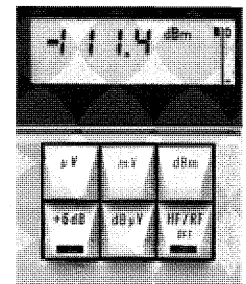

Repeated pressing of the keys offsets the frequency by a corresponding amount enabling receive channels to be selected in an easy manner.

The output voltage is specified in μV , mV , $\text{dB}\mu\text{V}$ or dBm , separate keys being available for conversion of the units (FIG 12). Starting with each RF level, the output voltage can additionally be reduced by 10 dB using an electronic attenuator as required for exact determination of the squelch hysteresis. The position of the attenuator is shown on the RF level display and reliably indicates the limits of the fine-variation range. The RF level can be varied rapidly using the two keys RF OFF and +6 dB.

Universal modulation possibilities are available: AM, FM and ϕM , internal and external modulation as well as combinations. Two integrated, separately adjustable AF generators enable two-tone modulation for simultaneous transmission of pilot and useful modulation or for SSB applications. An AF signal with a fixed level can be incorporated into the modulation via an additional socket on the rear panel; the second internal modulation attenuator can be used to set the modulation in this case.

The modulation generator in the SMFS 2 is a precise, temperature-stabilized RC generator with twelve fixed frequencies, that in the SMFP 2 an AF synthesizer with an extended frequency range and highest frequency accuracy. The latter is available for the SMFS 2 as option SMFS 2-B7. It can be used to set frequencies between 10 Hz and 25 kHz with fine resolution of 0.1 to 10 Hz. For applications such as frequency-response measurements, six important standard frequencies can be selected rapidly and directly by pressing a key and cycled in both directions.

The output signals of the AF generators are used for internal modulation and are also available for modulation of the connected transmitter via a precise AF attenuator with a high dynamic range from 100 μV to 5 V. The fine resolution even at low levels enables measurements to be made on transceivers with a sensitive microphone input. As a result of an output resistance of 0 ohms, the set output voltage corresponds to the voltage on the device-under-test and prevents faulty measurements in the case of frequency-dependent load resistances.

The SMFP 2 and SMFS 2 contain a second AF generator with selectable frequency for simultaneous generation of pilot and use-

ful modulation. In addition to the generation of subaudio frequencies for pilot purposes (private line, channel guard, controlled squelch), this is interesting for the generation of monitoring tones required in modern cellular-radio networks. The two fixed frequencies can easily be changed for applications with a fixed pilot frequency – for example 150 Hz in military applications.

The function of the selective-call encoder is based on the principle of frequency synthesis of the AF synthesizer. The frequency changes are characterized by phase continuity and excellent frequency and amplitude responses (see figure 22 on page 24). The selective-call encoder generates tone sequences with one to eight single tones according to the following standards: ZVEI 1, ZVEI 2, CCIR, CCIR (70 ms), EEA, Europaging Service. The setting to the particular standard and entry of the desired call is simply made using the keyboard; if a digit of the code is repeated, the standard repeat tone is generated automatically. The tone sequence is started by pressing a key once, pressing the key several times causes the call to be sent several times. It is also possible to select transmission of only the tone sequence or also with previous and subsequent transmission of the useful signal or free signal (Europaging).

The selective-call encoder has highly universal setting facilities and parameter variations:

- first tone with standard tone length (also 450 or 700 ms as extended first tone),
- repeat tone at first digit,
- alarm tone at first digit,
- alarm tone at last digit,
- programmable, customer-specified standards including repeat and alarm tones with single tone lengths of 33, 40, 70 and 100 ms with extension of the first tone to 450 or 700 ms.

With the SMFP 2 it is also possible to use simple IEC/IEEE-bus commands to produce tone sequences and to vary their parameters. Thus tones can be lengthened, pauses introduced and frequencies within the sequences varied to investigate tolerances. Completely new sequences can also be generated.

Measurement section, receiver test

In the receiver test the SMFP 2 and SMFS 2 use the set test parameters and the level of the AF output signal of the transceiver to measure the SINAD value or, by cyclically switching the modulation on and off, the signal/noise ratio with or without CCITT weighting. If a SINAD or S/N value is entered using the keyboard, the RF level is automatically varied by the test assembly until the specified value is reached. The RF level determined in this manner describes the sensitivity of the transceiver and is output on the RF level display. The corresponding SINAD or S/N values are output as true measured values on the result display. In addition to the automatic test routines to determine the sensitivity according to the S/N and SINAD methods, a third possibility is the quieting measurement.

Various time constants can be set with all three methods, thus enabling averaging of pulsed noise for minimum data scattering. The AF level meter is designed as a true RMS meter and retains the narrow limits required by the CEPT guidelines despite a wide frequency range.

The RF OFF key facilitates rapid testing of the squelch function; the squelch hysteresis can be determined accurately using the electronic fine level adjustment without interruption of the level. The test assemblies measure this automatically with a single keystroke and indicate the threshold and hysteresis separately. The 6-dB bandwidth of the receiver section is also measured automatically by the SMFP 2 and SMFS 2 and the bandwidth and centre-frequency offset are indicated.

The AF frequency response of the receiver can be determined by simply varying the modulation frequency or selecting several values in succession. The relative value in dB referred to the current measured value or the reference value entered on the keyboard can be output on the result display in addition to the display of the absolute value by a single keystroke.

The distortion meter determines the AF distortion of the transceiver at all frequencies prescribed by CEPT (300 Hz, 500 Hz and 1 kHz). To enable simple operation, the AF synthesizer is automatically set to the corresponding frequency when this measurement is selected.

Measurement section, transmitter test

In the transmitter test the SMFP 2 and SMFS 2 automatically measure:

- the transmit frequency of the transceiver with selectable resolution of 10 Hz or 1 Hz,
- the transmitter power up to 30 W (up to 60 W with option SMFP 2-B3) with display in watts or dBm,
- the modulation with either positive peak detection (+PK), negative peak detection (−PK) or the mean value of both (±PK/2), with high resolution and automatic switchover to RMS detection to determine spurious modulation at a meaningful limit or with pure peak or RMS detection.

The 60-W power meter (option SMFP 2-B3) extends the measurement range of the power meter built into the SMFP 2 and SMFS 2 from 30 W to 60 W (FIG 13). External power attenuators can be connected in series to extend the upper power limit even further. This attenuation value is automatically taken into account with all settings and displays once entered. Thus transceivers with any output powers can be measured exactly without relinquishing any ease of operation.

The demodulated signal is available at a separate socket for further analysis using an oscilloscope, spectrum analyzer or selective-call and radio-data decoder (eg Radiocode Test Set SCUD). The lower cutoff frequency for very small phase distortions is at <5 Hz, sufficiently low for the transmission of radio-data signals. To enable measurements on transceivers with automatic reply and/or selective call, the test assemblies can be set for a fastest possible demodulator response time by entering the transmit frequency of the transceiver (FIG 14).

The output level of the modulation generator is increased or decreased by pressing a key until a modulation set on the keyboard is reached. This then describes the modulation sensitivity for the set modulation and is displayed as a true measured value. The modulation-frequency response of the transmitter can be rapidly determined simply by further keystrokes. As with the

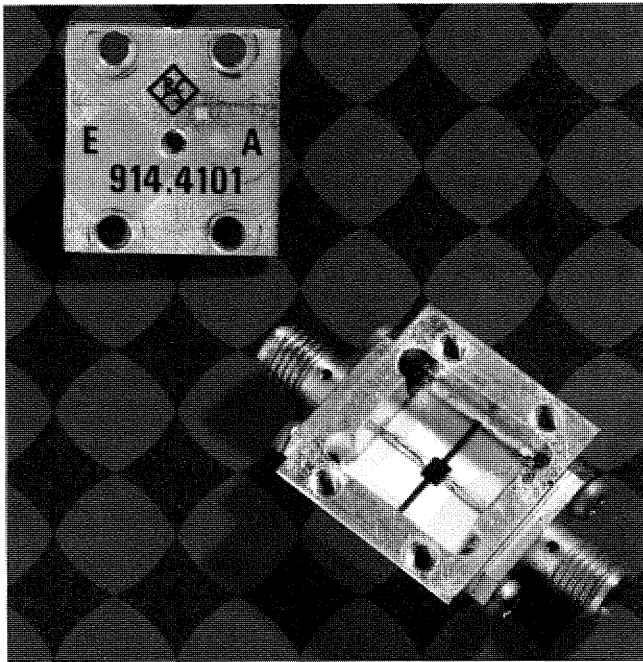

FIG 13 Precision attenuator made by R&S to increase power-measuring range to 60 W for SMFP/S 2. Connection-cable and socket attenuations resulting from design have been taken into account during construction in order to retain high measuring accuracy.

receiver measurement, the relative value in dB referred to the current measured value or the preset value can be read in addition to the display of the absolute value. The modulation distortion can be determined for all CEPT frequencies by pressing a key, the frequency of the AF synthesizer being automatically set to the corresponding value.

The signal/noise ratio of the modulated transmit signal is output directly in dB on the result display. The test assembly determines this value by cyclically switching the modulation signal on and off and calculating the S/N ratio.

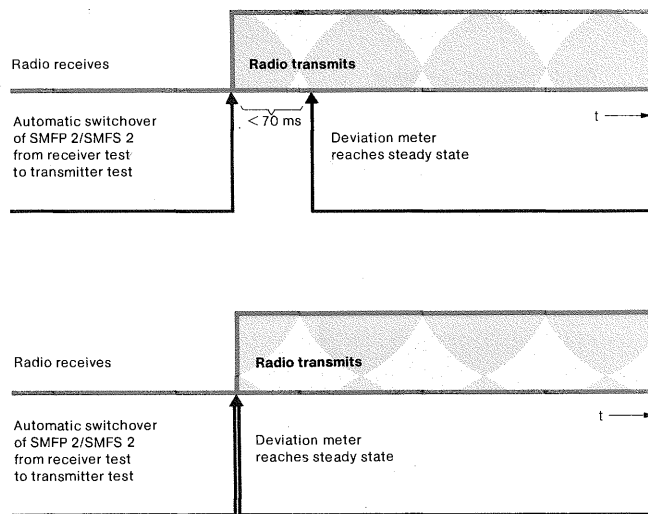

FIG 14 Timing sequence when testing duplex transceivers with automatic reply and different transmit and receive frequencies. Top: SMFP/S 2 without duplex deviation meter, bottom: SMFP/S 2 with duplex deviation meter.

The selective-call decoder (option SMFS 2-B6) is used to evaluate the tone sequences demodulated by the modulation meter. The decoded code numbers are output directly on the display and the repeat tones are decoded automatically. Excessive pauses or tones that deviate from the standard can readily be recognized as shown in the examples in FIG 15.

The adjacent-channel power meter (option SMFP B61) measures the transmitter power output into the adjacent channels with a high dynamic range of up to 80 dB. Only the nominal transmit frequency of the transceiver and the channel in which the adjacent-channel power is to be measured need be entered for exact determination. The result is displayed either as a ratio of the adjacent-channel power in dB, referred to the useful-channel power, or the direct absolute value in μW . The filters fitted in the adjacent-channel power meter correspond to FTZ, CEPT and IEC guidelines with respect to their extreme edge steepness throughout the attenuation characteristic. Together with the high frequency accuracy of the RF synthesizer, they enable highly precise measurements with an unmodulated carrier as well as with the application of standardized useful modulation and with the internal worst-case modula-

Examples for display of decoded tone sequences

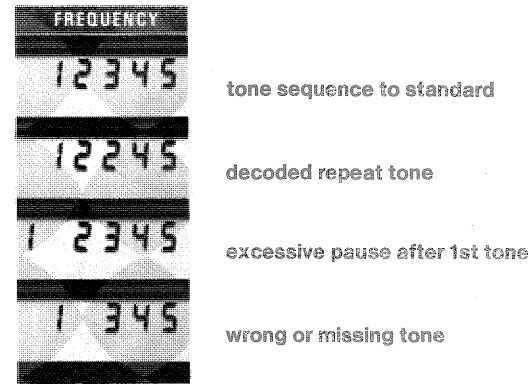

FIG 15 Display of decoded selective-call sequences on frequency display of SMFP 2/SMFS 2.

tion (radio data) specified for certain transceivers. Very low filter aging and internal, automatic calibration before each measurement mean that the adjacent-channel power meter will continue to produce reliable results for many years.

In addition to determination of the adjacent-channel power ratio, the option can be used to measure interfering signals (eg from spurious waves) with direct display of the ratio to the useful signal in dB (FIG 16).

A second, sensitive input is available for measuring low-power transmit signals (cordless telephones, etc). It can be used for frequency, deviation, selective-call, modulation-frequency-offset, frequency-offset, distortion and adjacent-channel power measurements. Off-air measurements are possible if an antenna is connected, with an antenna voltage of as low as approx. $100 \mu\text{V}$ following transmit-frequency input. It is then possible to test the functions of fixed transceivers such as car telephones or repeater stations at their point of installation.

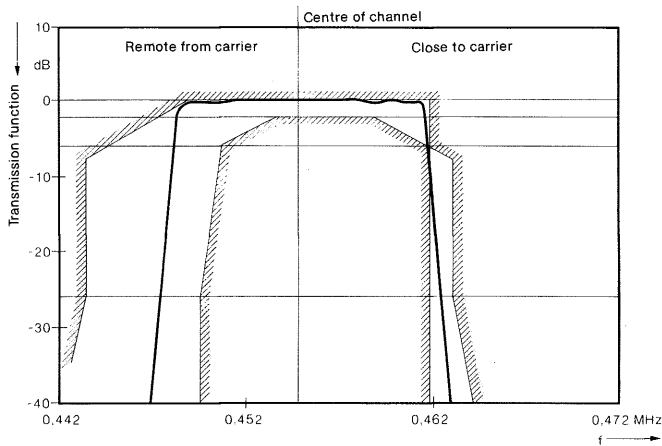

FIG 16 By means of precise mechanical filters, adjacent-channel power meter corresponds to all appropriate guidelines for simultaneous detection of all noise products.

Analog display

An **analog display** (option SMFS-B9) is available for the SMFP 2 and SMFS 2. This is a slimline, add-on unit with a **built-in AF oscilloscope** and two bar displays which can be assigned to different measurements. It offers additional checking capabilities and detectors with analog display to match the specific requirements of **production testing and servicing**. With its automatic setting feature for the oscilloscope and the bar displays together with the **AUTOLEVEL** key, which does away with the need for readjustment during transmitter and receiver tests, the optional analog display integrates easily with **automatic test systems**.

When operating in internal mode, the oscilloscope displays the demodulated signal in a transmitter test or the AF signal delivered by the transceiver in a receiver test, with switch-selectable time and amplitude resolution. The vertical deflection calibrated in V for AF, in kHz for FM, in % for AM and in rad for ϕ M ensures precise signal evaluation. By pressing a button, all signals can be displayed with constant amplitude, ie no adjustment on the oscilloscope is then required when test parameters such as modulation, modulation voltage and modulation frequency vary.

When operating in external mode, the oscilloscope displays the signal that is applied on the cable or measured by a probe (eg Oscilloscope Probe SMFS-Z1) with switch-selected coupling – AC or DC. The X signal is available at an additional socket and can be applied at an external modulation input for sweeping. Its level matches the input sensitivity so that the sweep width can be entered directly via the keypad.

The frequency-response curve is displayed directly on the screen of the analog display via the **Demodulator Probe SMFS-Z2**. A marker can be added at the centre frequency at the push of a button. Using the parameter variation keys on the basic unit, the centre sweep frequency can be shifted to find additional resonance frequencies, attenuation peaks or cutoff frequencies; the corresponding frequency can then be read directly on the RF display. This method is applied when measuring input and output stages, IF amplifiers, filters, duplexer filters and resonance circuits (FIG 17).

Overall sweeping – from the RF input to the AF output – provides a quick overview of bandwidth, centre-frequency tuning and sensitivity of the transceiver within the receiver bandwidth. The switch-selected CCITT filter ensures suppression of buildup or decaying transients in the transceiver. The superimposed centre-frequency marker permits points of interest, such as the lower or upper band limits as well as dips, to be checked and their frequencies to be displayed (FIG 18). The simultaneous display of both band limits simplifies centre-frequency tuning of the receiver. It is only necessary to ensure that the upper and lower band limits are at the same distance from the centre-frequency marker.

The analog displays are provided in the form of bars with bright-up scales with 50 graduations (corresponding to resolution of 2%) and result in an accuracy equivalent to high-quality pointer instru-

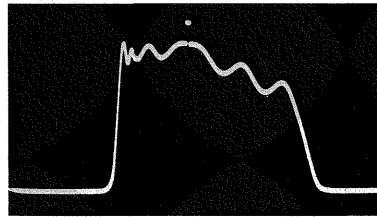

FIG 17 Sweeping of filter with frequency-response display and centre-frequency marker on screen of Analog Display SMFS-B9.

ments, without the possibility of parallax errors however and with elimination of reading errors. The scales, measuring ranges and time constants have been adapted to the special requirements.

The exact assignment of each scale division to a measured value, the different scales displayed depending on the measurement to be made plus the full-scale values shown on the screen ensure **unambiguous determination of measured values** (FIG 19).

The SINAD value and AF level are displayed in analog form in the receiver test, and the power and the highest modulation value (positive or negative, whichever is greater) in the transmitter test. An additional LED facilitates **modulation-symmetry adjustment**. In addition, the distortion of the AF output signal can be displayed in the receiver test and the modulation distortion in the transmitter test at the push of a button. It is also possible to display the voltage measured by the RF millivoltmeter in both modes. These two

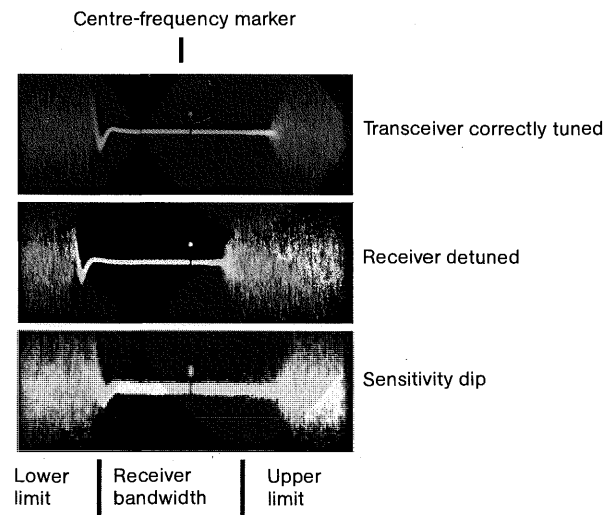

FIG 18 Sweeping of transceiver from RF input to AF output.

measuring capabilities can also be combined, for example simultaneous display of measured power and SINAD ratio when **adjusting duplex transceivers**. Simple adjustment to given nominal values (eg repeated measurements during production) is also possible by displaying tolerances separately for each bar. The tolerances can be set using potentiometers (FIG 20).

Testing full-duplex transceivers and repeaters

The Duplex Deviation Meter Options SMFP B41 (slimline add-on) and SMFP B91 (mounting in Analog Display SMFS-B9) are avail-

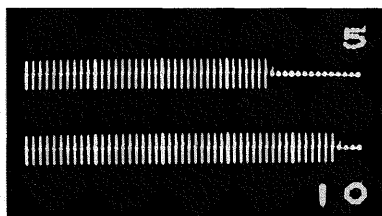

FIG 19 Analog screen displays with bright-up scales and indication of full-scale value.

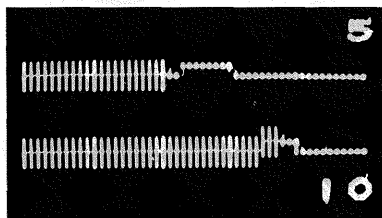

FIG 20 Analog screen displays with tolerances.

able for measurements on full-duplex transceivers and repeater stations. These options permit all **transmitter and receiver measurements** to be performed **simultaneously and independently** (FIG 21). The options are electrically identical; all connections to the main unit are made internally and automatically by the microprocessor. Independently of the frequency set on the RF synthesizer, the duplex deviation meter covers the entire **frequency range from 10 to 1000 MHz** and is therefore even suitable for radios with transmit and receive frequencies in different bands. The deviation range, demodulation-frequency range and the exceptionally low residual FM values are identical with the values of the main unit and it is therefore possible to carry out transmitter measurements – including **S/N ratios** – using the duplex deviation meters. A high demodulation-frequency range and low residual FM are of particular importance when working with modern car-telephone equipment such as **cellular radio** since such transceivers often require a receive signal to be present before transmission is possible. In such cases transmitter measurements can only be made with the duplex deviation meter.

Supplementary measuring and testing devices

A **high-impedance DC voltmeter** for up to 30 V with floating inputs is fitted for troubleshooting or determining the dependence of the transmit power on the power supply; the voltmeter also operates

at points which do not have the same potential. Direct currents between 0.1 mA and 10 A (briefly up to 20 A) can be measured by a **DC ammeter** in two ranges selectable via connection sockets with **automatic switchover**. The current consumption of a transceiver in transmitter and receiver operation can then be determined as well as of modules and subunits during manufacture.

The switch-selected CCITT filter in the SMFP/S 2 is inserted into the demodulation and AF-voltmeter circuits by pressing a button and is used for **psophometric evaluation of noise**. This produces interfering-modulation, S/N and SINAD values based on **comparable worldwide standards**.

An **RF Millivoltmeter** (option SMFS 2 B8) enables RF voltage measurements from 1 mV to 100 V over the range 10 kHz to 1000 MHz. Suitable probes are any of the probes and insertion units available for the RF Millivoltmeter URV. In addition to digital display in mV, V or dBm, the measured value can also be displayed on the built-in analog display. The RF millivoltmeter is not only useful for match-terminated measurement of the RF output level of modules and subunits during production and development, but also enables **reaction-free, RF level measurements** on oscillators, mixers, IF amplifiers, input stages, etc in all fields of radiotelephone applications when used with high-impedance probes.

A second input of high sensitivity is available in addition to the RF power input. It is used to determine the parameters of low-level signals and enables the device-under-test to be connected directly as well as reaction-free measurements on open transceivers using probes (FIG 22). A loudspeaker with adjustable volume and headphones connection is present in both test assemblies for **aural monitoring** of the demodulated signal, loudspeaker output signal and beat frequency.

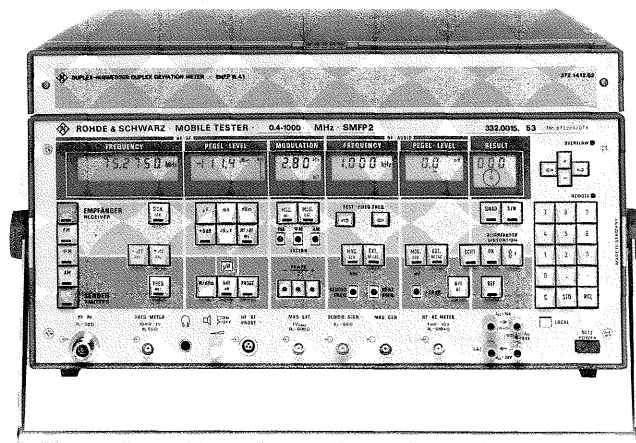

FIG 21 Mobile Tester SMFP 2 with Duplex Deviation Meter SMFP B41.

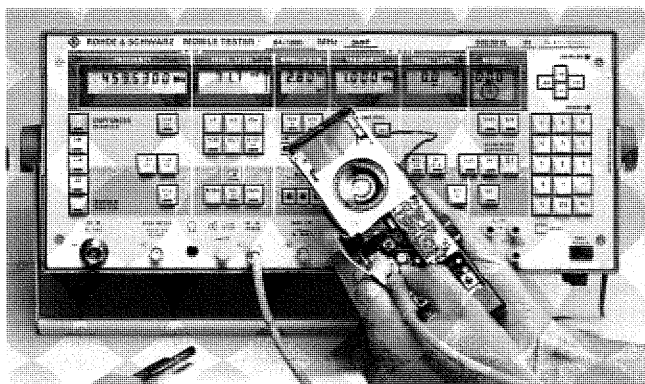

FIG 22 Rapid testing of RF levels in transceiver with high-impedance, non-reacting RF millivoltmeter probe.

The ideal partner for the SMFP 2 and SMFS 2 is the Radiocode Test Set SCUD for measurements on transceivers for radio data or with selective call. The test set generates and analyzes selective-call and radio-data signals in accordance with all known standards and methods. Thanks to its flexible software-based design, the SCUD permits the definition of any selective call and any message structure for a wide choice of modulation techniques (FSK, FFSK, DPSK, PSK) for customer-specific applications.

Two-signal measurements

For receiver measurements requiring two RF generators, the SMFP 2 and SMFS 2 are provided with an additional RF input/output on the rear panel, isolated by 30 dB from the RF input/output on the front panel. All two-signal measurements such as

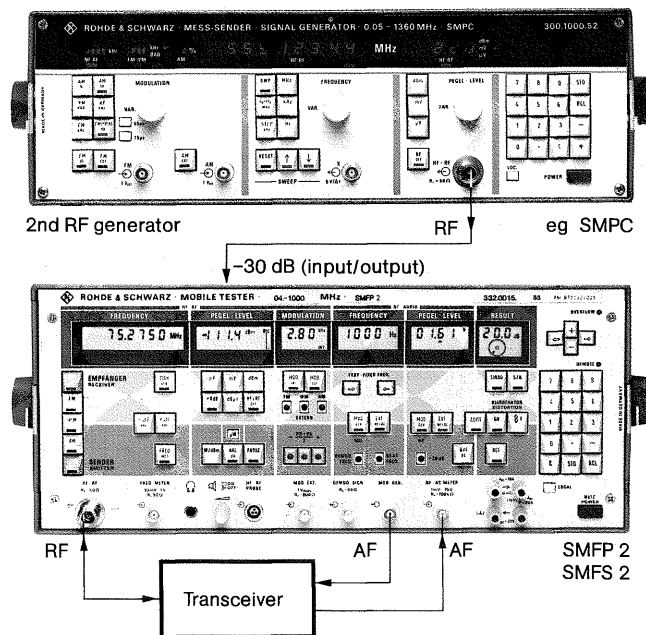

FIG 23 Simplest test setup for all two-signal measurements by adding Signal Generator SMPC or SMPD to SMFP/S 2.

- adjacent-channel selectivity,
- interchannel modulation and crossmodulation,
- blocking attenuation

can thus be carried out without requiring additional attenuators, distributors, etc.

For highest demands with critical two-signal measurements (eg determination of adjacent-channel selectivity) it is recommended to use an extremely low-noise, second RF generator with very low spurious content. Particularly suitable are the SMPC or SMPD from Rohde & Schwarz (FIG 23). The latter, with its wide frequency range up to 2.7 GHz, also enables measurement of spurious responses up to 2 GHz.

Michael Vohrer

CONDENSED DATA MOBILE TESTERS SMFP/S 2

	SMFP 2	SMFS 2
RF generator	0.4 to 520 MHz (1 GHz as option)	
Level	0.03 μ V to 1 V into 50 Ω	
Modulation	AM, FM, ϕ M	
Modulation generator 1	100 μ V to 5 V synthesizer/ selective-call encoder	12 fixed frequencies, synthesizer/ selective-call encoder as option
Modulation generator 2	10 Hz to 25 kHz	
AF level meter	400 Hz, 1 kHz	
Distortion meter	100 μ V to 10 V	
S/N meter	0.1 to 50%	
SINAD meter	6 to 46 dB	
RF counter	6 to 46 dB	
AF counter	1 to 520 MHz (1GHz as option)	
RF power meter	20 Hz to 1 MHz	
RF millivoltmeter (option)	10 mW to 30 W (60 W as option)	
Frequency-deviation meter	1 mV to 100 V	
Phase-deviation meter	1 Hz to 20 kHz	
Duplex deviation meter (option)	0.001 to 5 rad	
AM meter	10 MHz to 1 GHz	
Selective-call encoder	0.1 to 99.9%	
Selective-call decoder (option)	ZVEI, CCIR, EEA, option Europaging and programmable to ZVEI and CCIR	
DC voltmeter	9 relays, option 3x4 control lines	
DC ammeter	1 mV to 30V	
Adjacent-channel power meter (option)	0.1 mA to 10 A	
Channel spacings	10/12.5/20/25 kHz	
Measuring range	up to approx. 80 dB from carrier	
Control section		
Analog display (option)		
Oscilloscope	0 to 100 kHz	
Analog displays	for modulation, power, SINAD, distortion, AF and RF levels	
Remote control	IEC/IEEE bus	-
Ordering number	332.0015.53	332.8700.53

The increasing number of subscribers in different radio services worldwide cannot be matched by extending the available frequency spectrum. As a result it is necessary to make economical and optimal use of available frequencies. Special signalling procedures and the creation of cellular-radio networks support economical frequency utilization but also place high demands on the measuring facilities required.

From selective call through radio data to cellular radio

The times when one radio channel was reserved for each pair of subscribers are long past. Once it was realized that all the subscribers in radio services such as private transport, public transport or energy supply companies rarely need to talk at the same time, one RF channel was assigned to a major group of subscribers. To allow mobile stations to call or be called directly on such a common channel frequency, a separate call number is assigned to each subscriber.

A relatively simple method of addressing a mobile radio is the transmission and decoding of a tone sequence in the speech channel, ie a selective call. A certain tone frequency of exactly defined duration is assigned to each digit of the call number, so that for a five-digit call number for instance a sequence of five tones is required.

In each participating receiver a special decoder evaluates the tone sequences. Only if the received code agrees with the assigned code is the AF connected through to the loudspeaker. Thus all users of a common channel frequency do not have to listen to a call which is not intended for them. The selective-calling technique is relatively simple to implement since only AF components are required for the coder and decoder circuits. Moreover, there is no need to change the type of modulation.

Selective call

In its simplest and most widely used form the selective call consists of a sequence of five single tones (FIG 1), each tone frequency representing a specific digit of the call number. To ensure reliable and simple decoding even when two successive digits of a call number are identical, a repeat tone has been defined, which is sent instead of repeating a digit frequency (FIG 2).

Thus each subscriber has his own call number. A special tone frequency called the group tone is provided for simultaneous addressing of groups of 10, 100 or even 1000 subscribers (FIG 3). If this group tone is sent as the fourth tone of a five-digit call number for instance, all 100 subscribers will be called whose number begins with the same three digits.

In radio networks using relay stations it may be necessary to lengthen the first tone of the selective call since often slight delays occur before speech communication is established. The first tone is also lengthened in some paging systems to "wake up" the pager from an energy-saving standby condition for evaluation of the next call (FIG 4).

In some radio networks a so-called free tone is defined, which is sent permanently and only interrupted by the selective call. This is used for instance to monitor receiver quality and trigger a signalling device if quality is bad. Other networks use the presence of a continuous frequency in the subaudio range (FIG 5), which opens the squelch in the receiver.



FIG 1 Simplest form of selective call, consisting of sequence of five equally long tones.



FIG 2 To repeat single tone, so-called repeat tone f_R is inserted.

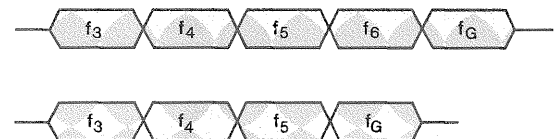

FIG 3 Simultaneous calling of ten (top) or 100 (bottom) subscribers by adding group tone.

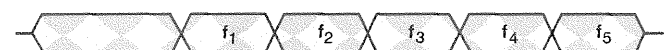

FIG 4 Lengthening of first tone, for instance to bridge signal delays in radiocommunication via relay stations.

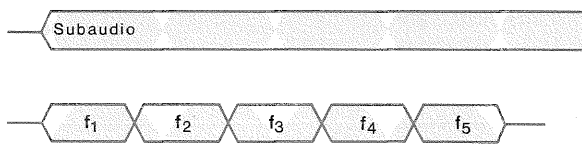

FIG 5 Simultaneous transmission of subaudio tone (top), which opens receiver squelch for instance.

Many modern systems use an **acknowledgement call** to provide confirmation of adequate field strength at the receiving location. With this method a mobile radio receiving its specific call will automatically switch to transmission and send a five-tone sequence as acknowledgement. In a quite simple way the transmitting end can thus ensure that the call is received and the identity of the called mobile is confirmed (FIG 6). Between the end of a call and the

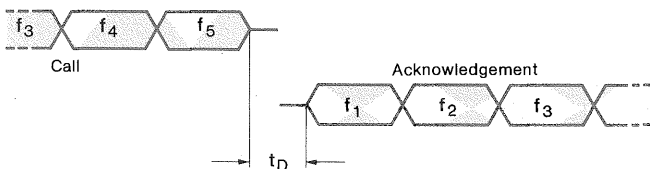

FIG 6 Selective call (left) and acknowledgement reply (right) after delay time t_D .

reply from the called mobile there is an acknowledgement delay time t_D , which is between 10 and 200 ms depending on the selective-call system used.

Selective-call standards

As a result of the high flexibility of the tone-calling technique a great variety of selective-call systems have come into use, which have been defined by various national or international committees and subsequently modified or enhanced by user organizations and equipment manufacturers. TABLE 1 shows a selection of the standards presently in use for selective calling.

Measurement requirements

The incorporation of selective-call facilities in transceivers means additional requirements when it comes to measuring equipment. The testing demands differ, of course, according to the area of work.

In **service shops** – ie the area of repair and maintenance – a simple **functional test** is usually sufficient. The test equipment used must be capable of generating any selective call to standard, but should also be flexible enough to allow for system-specific modifications (eg lengthened first tone, repeat tone at beginning of sequence, etc). In addition, the tone sequences sent by the mobile radio must be decoded and – within certain limits – evaluated for adherence to tolerances.

The **radio manufacturer** is faced with quite different problems in **final testing** and **quality assurance**, since the products he supplies must comply with standard specifications, which also include data referring to the selective-call devices. In addition to **control capability by IEC/IEEE bus** the test equipment required in these fields must therefore feature the following:

Standard	ZVEI 1	EIA	CCIR 1	EEA	CCITT	Euro
Tone duration (ms)	70	33	100	40	100	100
Pause duration (ms)	0	0	0	0	0	0
Code 0 (Hz)	2400	600	1981	1981	400	980
Code 1	1060	741	1124	1124	697	903
Code 2	1160	882	1197	1197	770	833
Code 3	1270	1023	1275	1275	852	767
Code 4	1400	1164	1358	1358	941	707
Code 5	1530	1305	1446	1446	1209	652
Code 6	1670	1446	1540	1540	1335	601
Code 7	1830	1587	1640	1640	1477	554
Code 8	2000	1728	1747	1747	1633	511
Code 9	2200	1869	1860	1860	1800	471
Repeat	2600	459	2110	2110	2300	1063
Alarm	2800		2400	2400		
Free tone						1153
Group tone	2400			1055		

TABLE 1 Overview of various selective-call standards in use.

- Generation of standard calls and calls with adjustable variations from the standard values of the basic parameters such as tone frequency, tone length and pause duration. This is the only means available to the manufacturer of checking his decoder modules for adherence to specified tolerance masks.
- Analysis of calls generated by a mobile radio, providing sufficient information about frequency, amplitude and length of the individual tones and the pauses in between. Measurement of acknowledgement delay time is also desirable.

The once common practice of testing selective-call devices by comparing them to devices from one's own production brings the danger of incompatibility within large networks using equipment of different makes. Although today's market offers a wide choice of encoders and decoders, the major drawbacks of most of these units are their inflexibility for special tone formats or customized tone sequences and the difficulties of integrating them into automatic test systems.

A development laboratory calls for even greater flexibility in its test equipment; a development engineer often has to experiment with tone sequences of his own definition. For him it is particularly necessary that **all parameters** of the encoder are individually defined and an accurate analysis is obtained from the decoder.

The Radiocode Test Set SCUD from Rohde & Schwarz is the first tester on the market which fully complies with the above requirements. More details are contained in the following article "Radiocode Test Set SCUD for selective calling, radio data and cellular radio".

Radio data

So far a method of transmitting information has been described which uses a tone sequence to represent a call number. In principle it would be possible to assign a tone frequency to each letter of the alphabet for transmitting complex information, but then an enormous amount of filters would be required for decoding. Quite apart from this, the time required for transmitting the information would be much too long. The technical solution to the problem is **digitization** and suitable **coding** of the data to be transmitted. Instead of a large number of different tone sequences only two values assigned to the binary states 0 and 1 are transmitted.

A binary transmission method features the following advantages:

- technically simple demodulation,
- distinctly higher data transmission speed,
- possibility of automated data exchange,
- detection and correction of errored communications by selection of a suitable code.

The information content of a binary message is defined by:

$$I = \log_2 \frac{1}{p}$$

where p is the probability of one of the two binary states occurring (ie p = 0.5). A binary message therefore has an information content of 1, the nondimensional quantity "bit" being used as the unit.

Value	Code
0	0 0 0 0
1	0 0 0 1
2	0 0 1 0
3	0 0 1 1
4	0 1 0 0
•	
•	
9	1 0 0 1
A(10)	1 0 1 0
B(11)	1 0 1 1
C(12)	1 1 0 0
D(13)	1 1 0 1
E(14)	1 1 1 0
F(15)	1 1 1 1
	$2^3 2^2 2^1 2^0$ Weighting
	8 4 2 1

FIG 7 Example of weighted code: 4-bit BCD code allowing coding of 16 possible values.

The transmission of the two possible states 0 and 1 alone does not constitute a true message. For the representation of complex information in binary form a coding method is therefore required. A simple example is hexadecimal code, a subcode of which is binary coded decimal code (BCD code). This belongs to the family of **weighted codes**, since a numerical value is allocated to each column of the code (FIG 7).

Coding methods

In hexadecimal code any combination of the four binary states is used for the definition of a message. If just one bit is not transmitted correctly because of noise or fading, a different message will result at the receiving end. In other words there is a **transmission error**, which cannot be detected in such a simple system.

To enable a transmission system to detect and even correct such errors, coding methods have been introduced which add a few bits to the message. These bits have no information content in the true sense and are only used for **redundancy**.

The simplest form of redundancy is **parity check**. An extra bit is added to the data word. The value of this bit is selected so that the sum of logic states 1 in the word, including the added bit, is either an even number (even parity) or an odd number (odd parity).

The various possibilities are shown for the letter B in 7-bit ASCII code:

7-bit ASCII B	1000010	
8-bit ASCII B, LSB even parity	1000010	0
8-bit ASCII B, LSB odd parity	1000010	1
8-bit ASCII B, MSB even parity	0 1000010	
8-bit ASCII B, MSB odd parity	1 1000010	

(LSB = least significant bit, MSB = most significant bit)

This additional, redundant bit enables a receiver to detect errors of one bit per word. It is however not yet possible to correct the error or detect two errors occurring at the same time. By adding further redundant bits, codes can be developed which even allow several errors to be detected and corrected. A **selection algorithm** in the receiver chooses the particular word with the highest probability of correct transmission.

A term used in coding is **hamming distance**. This describes the minimum number of bits by which words of the same code differ. In

BCD code, for instance, the hamming distance is only 1; by altering only a single bit a new word is already produced. Another frequently used term is **byte**. The byte is an 8-bit data word.

Data telegram

A message transmitted in digitized form without interruption is a data telegram. It is subdivided into various blocks, the smallest unit of which is the bit. The basic telegram structure is shown in FIG 8.

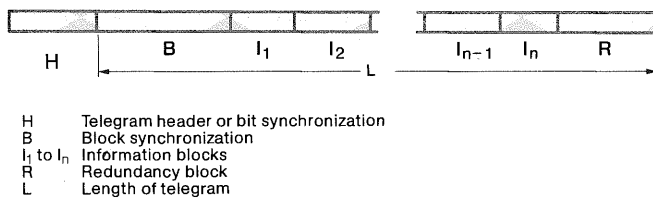

FIG 8 Basic structure of data telegram.

The **header H**, for instance a continuously changing sequence of zeroes and ones, enables bit synchronization at the receiving end.

The **block synchronization B** comprises a defined synchronization word which is known to the receiver and may be, for example, eight bits long: 00011000. It informs the receiver that a message will follow and that the transmitter can be requested to repeat the telegram if this word is not correctly received. The **information blocks I₁ to I_n** contain the message and usually have a defined length. If the information quantity is not sufficient to fill the previously defined block length, further bits (0 or 1) may be used to fill up the remaining space. To allow the quality of the data stream to be checked at the receiving end during data transfer, a **parity check bit** is often added at the beginning or end of a data word.

The **redundancy block R** is usually positioned at the end of the telegram and generated as a function of the telegram content in line with the mathematical definition used. Depending on the type of redundancy, transmission errors can be detected and corrected at the receiving end. If, for instance, the generator polynomial for defining the redundancy is

$$G = x^7 + x^4 + x^2 + 1$$

and the data telegram consists of an 8-bit word, the redundancy word (FIG 9) is generated as follows:

Data telegram

1	0	1	1	1	0	1	0
---	---	---	---	---	---	---	---

Generator polynomial $G = x^7 + x^4 + x^2 + 1 =$

1	0	0	1	0	1	0	1
			↓		↓		↓
			x ⁷		x ⁴		x ²
							x ⁰

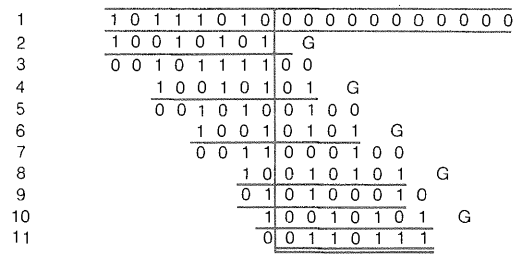

The redundancy word resulting from this example is:

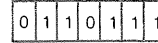

The telegram to be sent reads as follows:

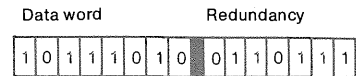

FIG 9 Generation of redundancy word.

The first eight bits of the data telegram (leading zeroes being ignored) are linked with the generator polynomial by exclusive-OR.

From the result in line 3 leading zeroes are eliminated and exactly the same number of bits from the following word added at the end: zeroes in our example, since the word is only eight bits long. Then the generator polynomial is added again, linked by exclusive-OR, etc. The final **telegram length L** is the sum of all bits, starting with block synchronization and ending with the redundancy block.

Transmission methods

For transmitting a data telegram, one of the following basic methods is usually adopted: either the binary data stream is used for direct phase or frequency shift keying of the RF carrier or a signal in the AF range (subcarrier) is modulated in frequency and phase and then applied to the modulation circuit of the transmitter.

For **subcarrier modulation** using the data telegram the following different methods are available:

- FSK (frequency shift keying),
- FFSK (fast frequency shift keying),
- PSK (phase shift keying),
- DPSK (differential phase shift keying).

To illustrate the differences between these transmission methods, the data telegram 1101001110 is shown in all modulation modes.

With FFSK the phase at the moment of the frequency change is clearly defined at the zero-crossing point as a multiple of 180°, as shown in FIG 10. In this example the transmission rate is 600 bit/s.

If a data transmission rate of 1.2 kBd (1200 bit/s) is required and if three half-cycles are to be allocated to a logic-0 bit and two half-cycles to a logic-1 bit, the logic-0 frequency is consequently 1800 Hz and the logic-1 frequency 1200 Hz.

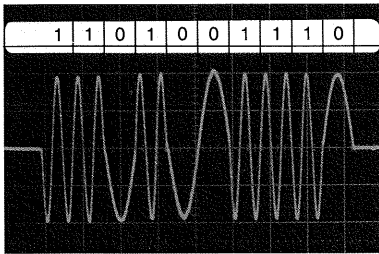

FIG 10 Data-telegram transmission with FFSK and 600 bit/s, phase at moment of frequency change being clearly defined at zero-crossing point as multiple of 180°.

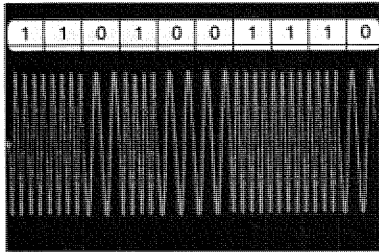

Fig 11 Screen display clearly showing FSK-typical shift of modulation frequency at moment of bit stream changing its state.

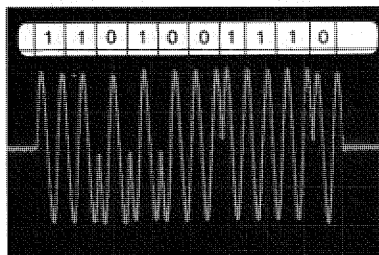

FIG 12 180° phase shift of modulation signal at zero-crossing point in PSK mode.

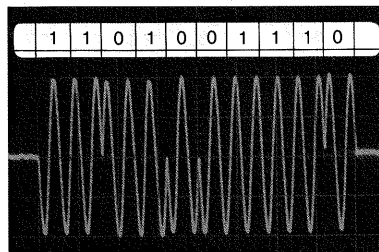

FIG 13 DPSK 0 with 625-bit/s transmission rate.

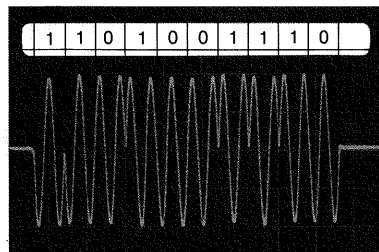

FIG 14 DPSK 1 with reversed logic of DPSK 0.

With FSK the shift of the modulation frequency at the moment the bit stream changes its state can clearly be recognized (FIG 11). The phase of the signal voltage at the moment of the frequency shift is irrelevant. In principle FSK can be regarded as a binary tone sequence.

The PSK mode shown in FIG 12 (180° phase shift of modulation signal at zero-crossing point) is a very commonly used method of data transmission. Its disadvantage is that the reference phase must be restored at the receiving end, which means that the initial phase must be known to the receiver and remain practically unchanged during data transmission.

In the DPSK 0 mode shown in FIG 13 the phase shift can clearly be recognized at the moment of logic 0, whereas no phase shift occurs for the time of successive logic 1s. If there are several successive zeroes in a data telegram, shifting *always* occurs after the defined number of logic-0 half-cycles. In the DPSK 1 mode shown in FIG 14 things are precisely the opposite. As long as the data telegram is logic 1, the phase shift occurs after the three defined half-cycles. If a logic 0 occurs in the data telegram, the signal in the example shown is continued by three half-cycles without phase shift. Phase rotation occurring in the DPSK model during data transmission on the transmission link or in the receiver has little effect since the reference phase can be recognized more easily.

BOS radio message system

The configuration of a radiotelephone network with additional data transmission will be described here using the radio message system of BOS (Behörden und Organisationen mit Sicherheitsaufgaben – authorities and organizations having security functions) as an example. This system allows a much shorter exchange of messages in the RT communication ranges by using digital telegrams instead of analog speech for specific messages. Depending on requirements, incoming telegrams are automatically acknowledged. The mobile transmitter usually expects acknowledgement of outgoing telegrams. If there is no acknowledgement, the telegram is automatically repeated. FIG 15 shows the time slots for messages and acknowledgements.

FIG 15 Time slots for messages and acknowledgements.

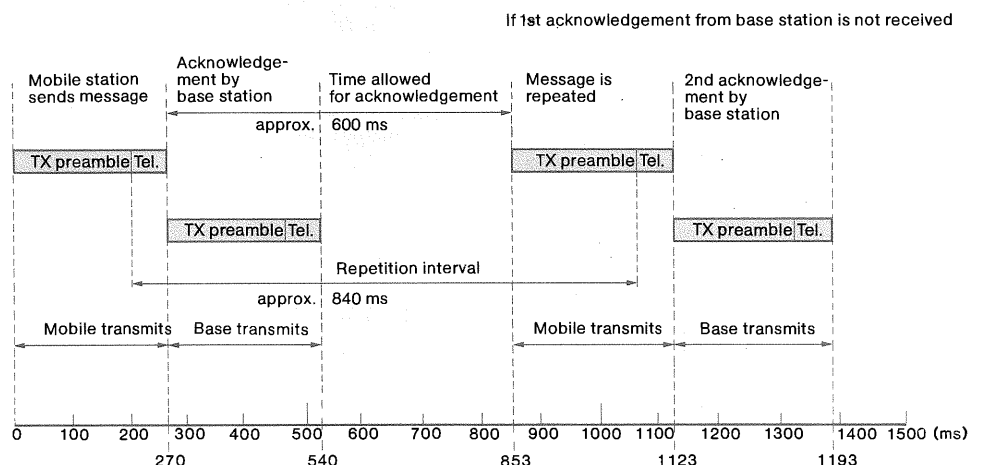

Coherent subcarrier FSK (similar to FFSK) with a transmission rate of 1200 bit/s is used for transmission, two half-cycles of 1200 Hz being allocated to logic 1 and three half-cycles of 1800 Hz to logic 0.

The outgoing telegram is preceded by a transmitter preamble of 200 ms. The telegram header consisting of a 12-bit sequence of logic 1s follows next. A change in polarity marks the transition from the telegram header to the block synchronization, which consists of a 7-bit Barker code and a filler bit.

Irrespective of the direction of transmission and information content, a data telegram always has the same structure and the same length of 48 bits. The received telegram is not evaluated until the block synchronization word has been correctly identified. Telegrams are sent in BCD code, the transmission direction being from LSB to MSB. A 7-bit redundancy word is added to the end of the data telegram for data security.

Telegram structure

The telegram is made up of 48 bits, the first 40 bits being secured (FIG 16). The remaining eight bits consist of a 7-bit redundancy and a free bit at the end, which is not decoded however. As shown by this telegram structure, 16 different information contents (bits 33 to 36) can be transmitted causing a specific indication at the receiving end.

The wide fields of application of radio data also include **paging systems**. In recent and future systems, like **POCSAG** (British Post Office Code Standardization Advisory Group) for instance, the pager not only delivers an acoustic signal but also displays alphanumeric data. The often very complex signalling protocols required for this purpose are generated and decoded by the Radiocode Test Set SCUD using software packages for selective calls, radio data and POCSAG; simulation and measurement of the specific system parameters are no problem at all.

Cellular-radio and conventional radio networks

Before discussing cellular-radio networks in detail, both the demands on a conventional radio network and its limits as to performance should be explained by a simple example. In the example assumed, an area of about 20 km in diameter and with a density of 25 subscribers per square kilometer is to be covered. This means that 7850 mobile radiotelephones are connected to the system. Assuming that 10% of all subscribers would like to make a call in the busiest period, approximately 800 duplex channels would be required.

In Europe the spacing between radio channels is usually 25 kHz, resulting in a frequency requirement of two times 20 MHz ($2 \times 800 \times 25 \text{ kHz} = 2 \times 20 \text{ MHz}$). To ensure sufficient field strength in the entire area to be covered, the base station must operate with adequately high transmitter power. This means that outside the area considered other RF channels must be allocated to avoid interference, ie another 800 duplex channels are required for each adjoining area of the same size and with the same number of sub-

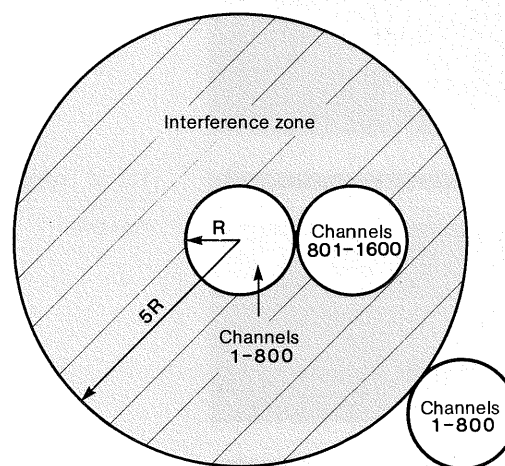

FIG 17 Interference problems of adjoining areas.

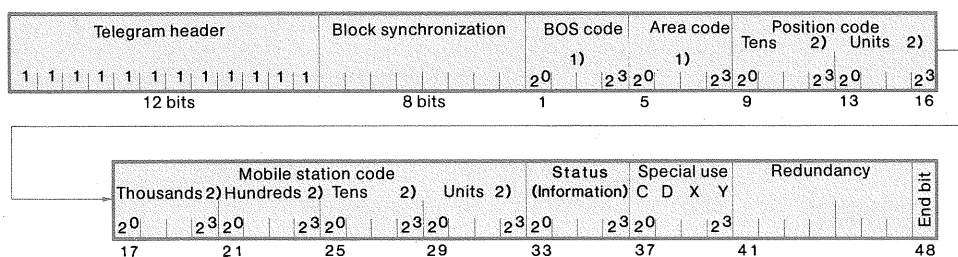

FIG 16 Telegram structure allowing 16 different information contents to be transmitted (bits 33 to 36).

Special use

C Configuration code C = \emptyset Configuration 1
C = 1 Configuration 2

D Direction code D = \emptyset Telegram from mobile to base station
D = 1 Telegram from base to mobile station

X, Y = Additional information

Length of telegram independent of information content and direction of transmission

1) Fixed binary number for identification of various security and emergency services, states within FRG and places

2) Binary-coded decimal number

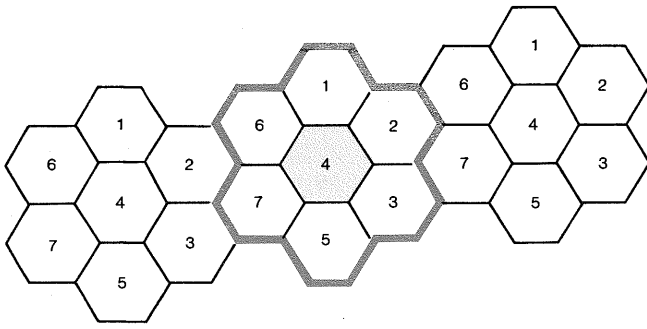

FIG 18 Areas to be covered by RF, subdivided into seven cells of same size.

scribers. FIG 17 illustrates the enormous frequency requirement to avoid interference.

Cellular-radio network

FIG 18 shows the same area to be covered having a radius of 10 km, with the difference that it is divided into seven equal cells. In this case too, an available frequency spectrum of 40 MHz corresponding to 800 duplex channels is assumed. Consequently, one seventh of the 800 duplex channels is assigned to each cell in this structure, ie channels 1 to 115 are assigned to cell 1, channels 116 to 230 to cell 2, channels 231 to 345 to cell 3, etc. If the radio channels in the adjoining areas are assigned in the same way, the distance between cells with the same radio frequency is five times the cell radius. Interference problems are thus reduced to an acceptably low level.

The main advantage of this cellular structure is the **reuse of the same RF channels** and hence the coverage of areas of any size. Moreover, this system can also be adapted for a greater number of subscribers by making the cells smaller. The fact should not be overlooked however that the large number of base stations and computer systems for system monitoring and proper call transfer to the normal telephone network involves enormous investment.

The basic structure of a cellular-radio network is shown in FIG 19. A number of base stations is connected to a superordinate mobile switching centre via data lines. This mobile switching centre has all information about the current occupancy of the subordinate cells and even knows which of the mobile subscribers is in which cell. Mobile switching centres are interconnected in a network structure for data exchange and connected to the public telephone network using lines via public switched telephone network exchanges.

Operation of cellular-radio networks

To ensure proper functioning of a cellular-radio network the following basic requirements must be fulfilled:

- Each base station must be informed about the mobile subscribers currently within its area.

- Each base station must be able to monitor and influence the quality of radiotelephone communication.
- Correct charging of calls must be ensured.

To find out which mobile subscribers are presently within the range of a base station, the mobile phones in standby mode, for instance, are requested from time to time to switch on their RF carrier and identify themselves by their data telegram. This data telegram contains the call number, serial number and maximum RF carrier power. The subscriber has no influence on these cyclically repeated messages.

In this way each base station knows the number and identity of the mobile subscribers within its range of coverage. It identifies subscribers in their home area, records visitors from other areas and reports them to a superordinate computer which, via data links, informs the switching centre of the home area concerned of the presence of the visitor. In this way it is ensured that each subscriber can be called at any time.

For monitoring and influencing the quality of radiotelephone communications, the following methods are used in the various cellular-radio networks:

- Field-strength measurements are used to determine which transmitting/receiving station is best for receiving calls from the mobile radiotelephone.
- An AF signal sent from the base station to the mobile phone and back to the base station is used for monitoring S/N ratio.

Because of the continuous data exchange, the base station knows both the momentary and the maximum output power of the mobile phone. By sending corresponding data telegrams, the base station can cause the mobile phone to switch to a higher or lower power level or, if necessary, to another RF channel. The available RF power range can be adapted to current requirements from about 10 W down to a few milliwatts.

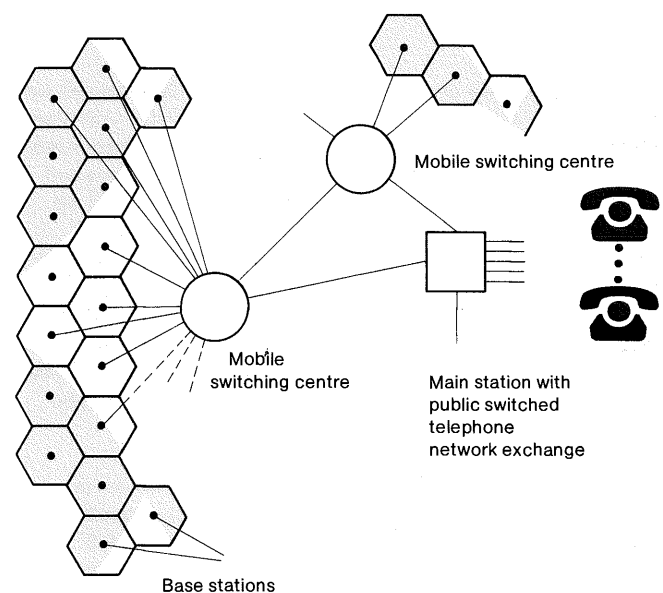

FIG 19 Basic configuration of cellular-radio network.

TABLE 2 Overview of cellular-radio networks in use worldwide and their characteristic features.

System	NMT	AMPS	TACS	Japan NTT	Radiocom 2000	Network C
Number of RF channels	180 or 220	666	1000	600	256	222
Channel spacing (kHz)	25	30	25	25	12.5	20
Duplex spacing (MHz)	10	45	45	55	10	10
Signalling speed	1200 bit/s	10000 bit/s	8000 bit/s	300 bit/s	1200 bit/s	5280 bit/s
Subcarrier modulation	FFSK	PSK	PSK	PSK	FFSK	direct carrier keying (NRZ)
Frequency range (MHz)	454 to 468	825 to 890	890 to 960	870 to 940	406 to 430	451 to 466

In addition to the location, the **positive identity** of a mobile phone must be known for correct charging of the calls. The identity is secured by using highly redundant coding of a subscriber's number.

SCUD provides for decoding. The SCUD implants error bits into the data stream to allow checking of the error-correction facility of a mobile phone.

Finally, after checking and measurement of the signalling parameters of a mobile phone, the controller capability of the SCUD can be used for fully automatic control of the test assembly for the usual transmitter and receiver measurements.

Manfred Grossmann

Résumé

It is easy to recognize that radiotelephony is constantly gaining in importance. Considering that with the aid of a cellular network structure cells with a diameter of less than one kilometer can be implemented, it is easy to imagine that portable radiotelephones with a few 100 mW of RF output power will come on the market at an attractive price. TABLE 2 provides an overview of the cellular-radio networks presently in use worldwide and their characteristic features.

Because of the very complicated signalling in the different cellular networks, the measuring instruments used should have **universal capabilities**. The data-telegram exchange between test assembly and mobile phone, for instance, must take place in **realtime** and should allow troubleshooting down to bit level for error analysis.

Data duplex traffic is a mandatory requirement. Modern radiotelephones often have response times of a few milliseconds. This means that the duplex deviation meter of the test assembly must be accurately and extremely rapidly presettable to the frequency of the channel in which a called mobile phone will reply; otherwise there is either a loss of information or the desired call will not be set up.

The Rohde & Schwarz systems SCUD/SMFP 2 and CMT are powerful testers for cellular radiotelephones. By loading the specific software package into the SCUD, the test system SCUD/SMFP 2 becomes the base station of a BOS, NMT, AMPS or TACS network with all the specific signalling protocols. The data telegrams sent by the mobile phone are demodulated by the SMFP 2, while the

The Radiocode Test Set SCUD is a valuable addition to the wide range of Rohde & Schwarz radiotelephone measuring equipment. A program-controlled AF synthesizer, universal evaluation section and integrated process controller enable the SCUD to generate and evaluate practically all selective-call and data telegrams transmitted by radio. It is used in production, in the test shop and in the laboratory as a stand-alone measuring instrument, in conjunction with the radiotelephone test assemblies SMFP 2, SMFS 2 and CMT in all fields of transceiver measurements, and together with the Mobile Tester SMFP 2 for measurements on mobile stations of cellular-radio networks.

Radiocode Test Set SCUD for selective calling, radio data and cellular radio

FIG 1 Radiocode Test Set SCUD. Detached keyboard only for numerical entry in manual mode; normal operation of test set by softkeys. SCUD can also generate complex signals (background) thanks to its versatile synthesizer.

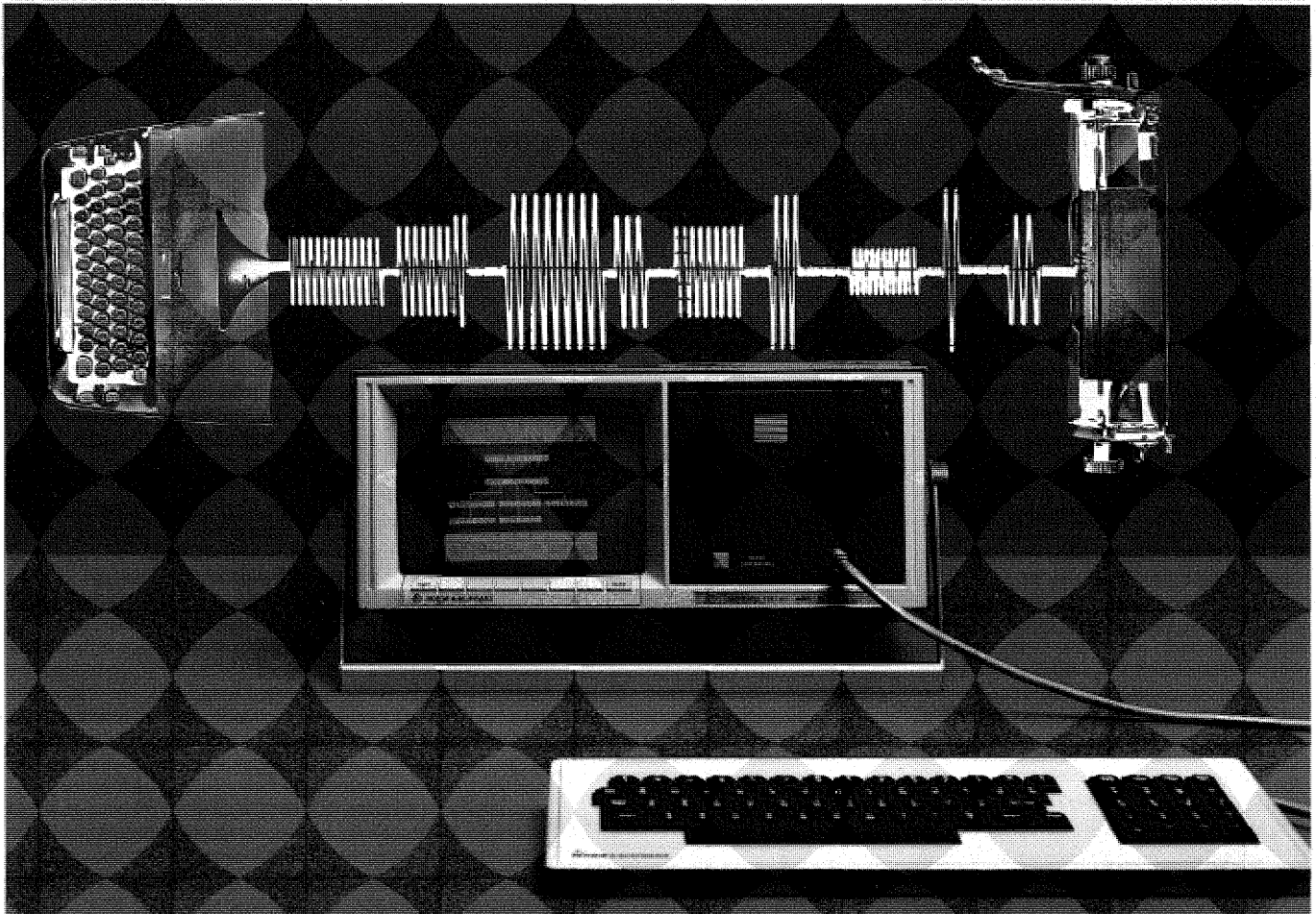

With the aid of programs supplied on floppy disks or additionally available, the user himself chooses the test function of the Radio-code Test Set SCUD – selective-call or radio-data testing – and the operating mode – manual operation by softkeys, automatic mode controlled by user program or remote control via IEC/IEEE bus. FIG 1 shows the SCUD with a detached keyboard, this only being used for numeric entries in manual mode. Virtual operation is made by softkeys.

With the **Software Package SCUD-K1** supplied as standard, the SCUD operates as a **selective-call encoder and decoder**, generating and evaluating **all common standard sequences as well as any customer-specific tone sequences**. Each parameter of a tone sequence (frequency, tone duration, pause duration and voltage), can be **freely programmed** (FIG 2).

Through the **Software Package SCUD-K2** supplied with the equipment, the SCUD becomes a **generator/analyzer for radio-data signals**. Its high flexibility makes it suitable for a great variety of applications from simple performance testing of a data module (modem) through to setting up and operating a radio data link including evaluation of the test parameters.

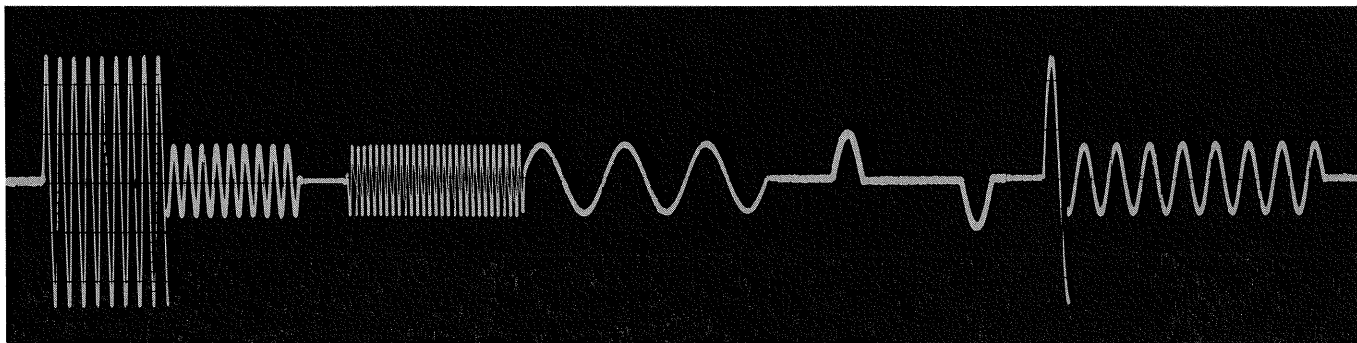

FIG 2 Complex signals like this can be generated by SCUD and analyzed in many parameters.

For measurements on mobile stations of **cellular-radio networks** special program packages based on the general radio-data software are available, which take account of the particular features of the individual networks as well as the often very complicated signalling protocols and control the operation of the SCUD in conjunction with the associated Mobile Tester SMFP 2.

Further software packages for special applications, eg for **POC-SAG**, are available. The AF synthesizer integrated in the SCUD is used as a program-controlled signal generator, thus replacing external AF voltage sources and opening up completely new fields of application.

Design and characteristics

The essential component of the encoder section of the SCUD is the **program-controlled AF synthesizer**. Its characteristics and specifications allow all required signals to be generated:

- frequency range 20 Hz to 25 kHz
- crystal-accurate with high resolution
- zero settling time for frequency and amplitude change
- level range 0 to 2000 mV, resolution 0.5 mV
- phase change possible at every zero crossing

- two-tone generation via summing input
- tone duration down to half a signal period
- pause duration between tones 150 μ s to 3 s

The high-performance measuring section of the SCUD contains various frequency meters and a peak voltmeter which **operate simultaneously and cover the entire range**, as well as switchable weighting filters.

The frequency meters – designed as gate-time counters or period meters depending on the particular application – are used for time measurement of the signals to be evaluated. Storage capacity is available for a practically unlimited number of measurement results.

The voltmeter measures positive or negative peak voltages and provides a stable value after no more than one signal period (for $f < 5$ kHz). An almost unlimited number of voltage values can be stored. The measurement rate of the peak voltmeter is controlled by the signal itself or can be preset by an internally generated and programmable clock.

A highpass, a lowpass and a bandpass filter are available as input-weighting filters. In conjunction with switch-selected autoranging

and a programmable trigger level, these filters enable the suppression of unwanted signal components and thus direct evaluation of the signal of interest.

The **process controller integrated** in the SCUD with 32 Kbytes of memory capacity is not only able to control the measurement process – including external measuring instruments – but may also be used independently for any other applications. The performance of the SCUD process controller is comparable to that of the powerful Process Controller PUC from Rohde & Schwarz:

- built-in floppy-disk drive
- Basic and machine language as programming languages
- IEC-standardized data and command formats
- talker and listener function on IEC bus
- excellent RF shielding, therefore very low RF leakage and high RF immunity
- connector for Universal Printer of PUD family
- can be extended by a great number of options (high-resolution graphics, realtime clock, RS 232 C interface, second floppy-disk drive, input/output interface)

Selective call

The testing of selective-calling devices was carried out until now with instruments operating on the principle of a go/nogo test.

More accurate results were achieved by defining the limits between "go" and "nogo" more precisely. The transition from testing to accurate measurement called for the use of large systems which needed a computer with high storage capacity and a high-speed, high-resolution system voltmeter on the measuring side alone. Furthermore, elaborate control and evaluation software had to be produced.

Things are different and simpler with the SCUD: the Selective-call Software Package SCUD-K1 contains the complete program for use of the SCUD as a selective-call encoder/decoder, permitting simple and fast tests or measurements of all parameters of selective-calling devices. The scope of the measurements affords much more information on the state of the device under test than does the conventional go/nogo test.

Selective-call encoder

The selective-call encoder generates all standard sequences of one to 15 tones from the frequency range between 300 Hz and 4 kHz as well as customer-specific tone sequences. The floppy disk SCUD-K1 supplied with the set does not only contain the data for the standard sequences ZVEI 1, ZVEI 2, CCIR, EEA, EIA, CCITT, VDEW, NATEL and EURO, but also data fields for freely programmable frequency sequences. The frequencies of these sequences may be used either to standard or be varied in fine increments for the limit-performance test of the decoder. If required, the selective-call encoder outputs one frequency of any tone sequence as a continuous tone during the pauses (free tone).

The tone and pause durations of the standard sequences are stored on the floppy disk SCUD-K1; it is however also possible to



FIG 3 Definition of special sequences with SCUD: frequency, tone duration and pause duration are freely settable.

program any deviations from the standard (0 to 3000 ms). The programmable voltage range is identical with that of the AF synthesizer (0 to 2000 mV). All frequencies, tone and pause durations may be overwritten by customer-specific data and be extended to a practically unlimited extent by using further floppy disks.

Special tone sequences permit sequences where, in addition to the frequency associated with the tone number, an individual amplitude plus tone and pause duration are allocated to each tone (FIG 3). In this mode, measurement tasks completely different from the previous selective-call standards can be fulfilled. It is for instance possible to generate two or three successive, different tone sequences with defined pauses, or bursts with any, even an irregular, duty cycle. A summing input is available for two-tone generation. An external signal can be added to the internal signal via this input.

The selective-call encoder features universal start possibilities: one-shot, continuous repeat, acknowledge (on starting the call, the decoder is armed for reply) via keyboard, program or remote control.

Selective-call decoder

The stored data referring to frequency, tone and pause durations of the standard sequences or of freely programmed sequences are used both for the selective-call encoder and decoder. The decoder derives the call number or selective-call sequence from the period durations and the measured frequency values. Tolerance bandwidths of the frequency and acceptance bandwidths of tone and pause durations are software-controlled and can therefore be varied within wide limits. The exceeding of tolerances or

measurement ranges as well as completely undefinable signals are already marked in the decoded call number (FIG 4).

Since the decoder can evaluate a call with up to 37 digits, tone structures greatly differing from the standard, eg tone sequences with multiple repetition, successive different tone sequences or tone sequences with lengthened first tone can also be analyzed.

Settings possible on selective-call encoder

Standard/frequencies	one of 14 international standard sequences or any user-definable sequences (can be extended with the aid of floppy disk)
Frequency variation from standard	frequency variation in percent up to $\pm 49.9\%$ from the standard for limit-performance test of decoder to be measured
Call numbers	length of call: one to 15 digits (digits 0 to 9, A to E)
Tone duration	commonly for all tones, separately for each digit, variation in ms
Pause duration	commonly for all pauses, separately for each pause, variation in ms
Voltage	commonly for all digits in call, individually for each digit
Number of calls	freely programmable; various start and abort possibilities for call via trigger line, keyboard or program-defined
Free tone	one frequency of selected standard sequence can be chosen as continuous free tone
Continuous tone	encoder may be used as AF synthesizer, programmable in frequency (20 Hz to 25 kHz) and voltage (0 to 2000 mV)

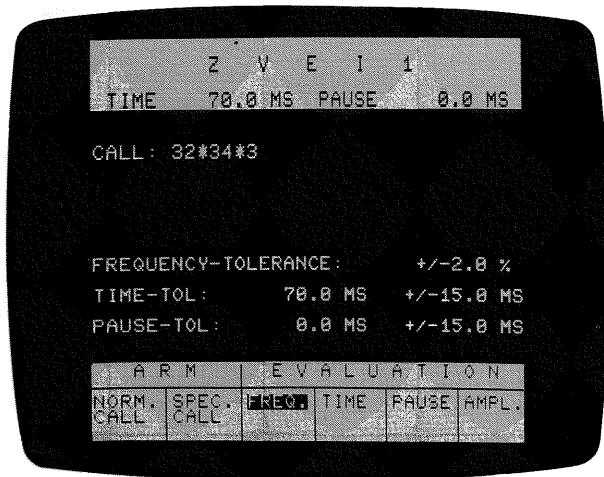

FIG 4 SCUD decodes call number from tone sequence. Marking after second and fourth tone as well as flashing frequency key indicate that preset tolerances have been exceeded.

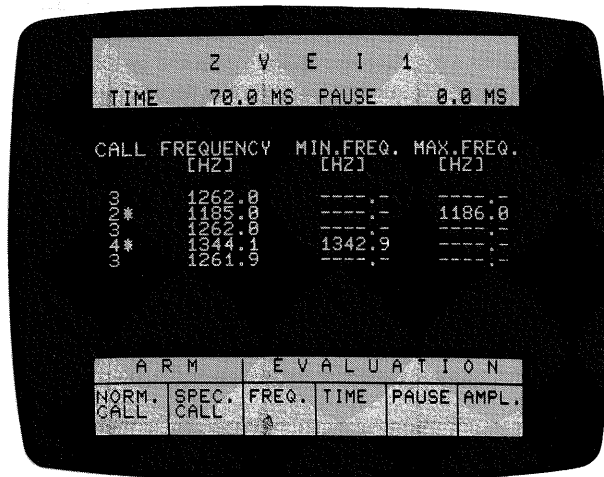

FIG 5 Frequency evaluation: SCUD indicates for each tone mean frequency (left column) and in case of exceeded tolerances minimum or maximum frequency (centre and right column).

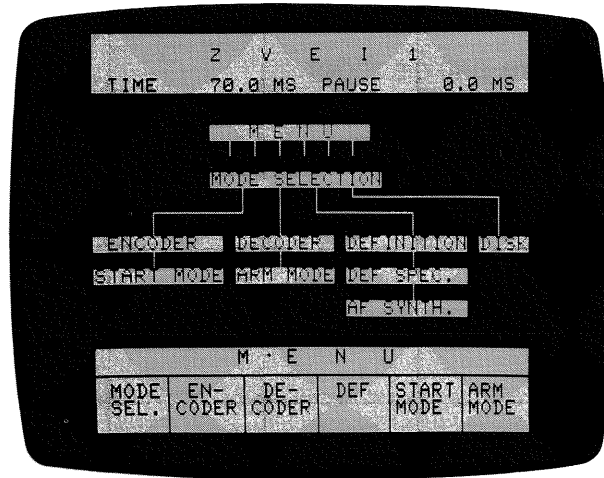

FIG 6 Operating structure of SCUD. Starting from this menu, any subroutine is either directly accessible or along displayed paths via softkeys.

The SCUD identifies the standard of unknown selective calls. After calling up the acknowledge start on the selective-call encoder, the period of time elapsing between the end of the call output and the arrival of the call at the decoder is automatically measured. It is directly displayed as an acknowledge delay.

The SCUD features test depth that goes far beyond simple call decoding. For each tone in the sequence the following information is available:

- mean frequency or maximum and minimum frequencies if the tolerance of each tone is exceeded (FIG 5)
- duration of each individual tone
- pause duration following each tone
- mean voltage, maximum voltage and minimum voltage of each tone

The decoder is armed for evaluation via the keyboard, under program control or via a remote-control line. The measurement process may be stopped from the keyboard or via a control line or automatically after a defined pause duration. Subsequently the results are automatically evaluated.

A programmable trigger level together with autoranging and different input filter configurations (HP, LP, BP) permits noise and interference to be suppressed so that the signal proper is correctly evaluated. A freely programmable hold-off provides for suppression of unwanted signals (eg spikes preceding a selective-call sequence caused by switching on the transmitter).

Operating concept

With manual operation through softkeys, the software-controlled keys, which are redefined according to the measurement function for easy interpretation, offer reliable user prompting. Two additional keys permit rapid changing between the main modes and sequential switching within the operating structure. The measurement parameters are entered via the keyboard (FIG 6).

In automatic mode the basic software controls the sequence of measurement and consists of a combination of subroutines for settings and measurements that are called up in a program written by the user to suit his requirements (without extensive programming knowledge being necessary). The basic software also includes routines that are extremely helpful in programming complex measurements and save a lot of time. All commands of the Basic language can of course also be used in the user program. Due to its controller features the SCUD can additionally and simultaneously be used for controlling other equipment.

Radio data

A commonly used method of transmitting data by radio is to encode logic 0 in the form of three half-cycles of a frequency of 1800 Hz and logic 1 in the form of two half-cycles of a frequency of 1200 Hz.

When the floppy disk SCUD-K2 is used, the SCUD tests and measures radio-data facilities not only within this system but in a much wider range. The following modulation techniques can be selected:

FSK (frequency shift keying). The logic-0 and logic-1 condition can be allocated to any frequencies between 300 and 4000 Hz; frequency switchover is effected with no jump in phase (FIG 7).

FFSK (fast frequency shift keying, with frequency change at the zero-crossing point). The number of half-cycles for one bit of the logic-0 and the logic-1 frequency is freely programmable; it thus determines the transmission rate (FIG 8).

PSK (phase shift keying). The modulation signal undergoes a phase shift of 180° at the zero-crossing point when the logic state changes; the number of half-cycles for one bit is freely programmable (FIG 9).

DPSK 0, DPSK 1 (differential phase shift keying). A phase shift corresponds to logic 0 or logic 1; otherwise the same as PSK.

For each serial data transmission with binary values, as is usual for radio transmissions, a certain protocol must be agreed so that the content of the bit stream can be determined. The largest information unit to be transmitted coherently is the telegram. Each data telegram is made up of blocks containing the bits as the smallest information units. This telegram structure makes for the great versatility of the SCUD in data generation and evaluation according to virtually any conventions.

The telegrams may be freely programmed down to bit level. The following codes are available for the formulation of bit sequences: binary; hexadecimal/BCD; ASCII 7 bits, ASCII 8 bits (LSB even and odd parity, MSB even and odd parity); user-defined 1 to 8 bits and any user-defined codes.

The transmission direction and logic state can be inverted for each code character. **Up to 253 blocks with 1 to 128 bits** can be formed. The block types are distinguished according to format-oriented, format- and content-oriented as well as synchronization blocks. In addition, two redundancy blocks can be generated according to predetermined or to user-defined stipulations.

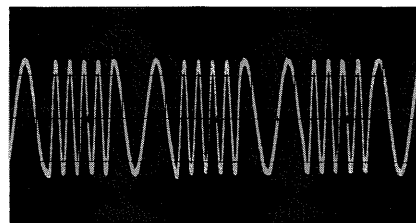

FIG 7 Frequency keying in FSK modulation mode is effected in SCUD with no jump in phase and without transient frequency and amplitude response.

FIG 8 Frequency switchover after few half-cycles exactly at zero-crossing point without transient response is characteristic of standard FFSK signal as used for instance in NMT system (Nordic Mobile Telephone) and radio data transmission to ZVEI.

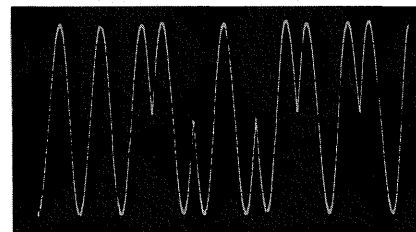
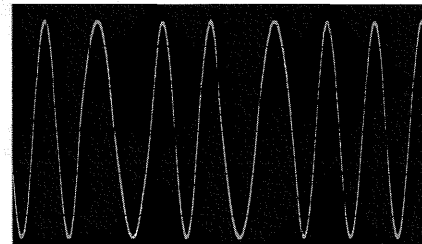

FIG 9 Section of PSK data telegram as example of exact generation by SCUD.

In addition to the system-inherent program data, the settings for measurements and testing are also freely programmable:

For the generator:

- Percentage deviation of frequency from nominal frequencies
- Output voltage
- Initial phase of telegram
- Pause tone (frequency before and after telegram)
- Duration of call pause

For the analyzer:

- Input-filter characteristic: HP, LP, BP, flat
- Tolerance in ± % of nominal frequency
- Measured voltage (positive or negative peak)
- Autoranging on/off for optimum gain range
- Trigger threshold

For acknowledge mode:

- Hold-off (end of telegram output to readiness for evaluation)
- Acknowledge delay (end of received telegram to sending of reply telegram)

For evaluation the SCUD collects a multitude of data consisting of measured time, period and voltage values; from these it determines the content of the received telegram according to the given telegram structure. After selection of the code any block of a tele-

Block type differences

Block types	Analyzer function
Format-oriented	The analyzer recognizes the telegram received through the format of the internal telegram structure
Format- and content-oriented	The analyzer checks the telegram received against the structure telegram, comparing format and content
Synchronization block	The analyzer synchronizes the telegram received with the corresponding block of the structure telegram

gram may be output. In addition, it is possible to read out the telegram without reference to the block format.

From the measured data the SCUD also derives the modulation frequency or its deviation from the nominal value, the transmission rate, the signal voltage and the acknowledge delay. The evaluation of the telegram in the form of error markings localizes any transmission errors. The error markings refer to the exceeding of frequency tolerances, to format errors and content errors.

In the acknowledge mode, one of four predetermined telegrams, depending on the content of the received telegram, can be sent. In case the content of the received telegram is not recognized a fifth predetermined telegram is sent. Any selected telegram can be sent one to 255 times. If the expected reply telegram fails to arrive or contains errors, a call will be sent again. The upper limit of these cycles can be programmed.

Apart from use as a program-controlled generator/analyzer for radio-data signals the SCUD can be operated as a modulator. It delivers the signal appropriately modulated when a clock or an external data stream is applied to the TTL input.

The free programmability of the generator/analyzer makes the SCUD suitable for known data-transmission techniques such as ZVEI and BOS (FIG 10) and moreover permits all system-specific modifications such as telegram extension or block structure modification; adaptation to future techniques is no problem.

Beyond the simple go/nogo test the high internal intelligence permits, on the generator side, the variation of all transmission parameters including error implantation for checking error correction in the radio equipment and, on the analyzer side, the exact analysis of detected data telegrams.

tion and evaluation of data telegrams and the behaviour of the SCUD. With this software the SCUD can be programmed by simply calling up existing routines. The remaining memory space permits the generation of user programs for optimum adaptation of the SCUD to particular measurement tasks (FIG 11). For simple measurement tasks the SCUD functions as a process controller for measuring instruments connected to the IEC bus; for complex measurements, the IEC-bus control of the SCUD from a control computer, eg the PUC or PCA 5, with unlimited storage capacity is available.

```

100 gosub30000
110 print"the data telegram to be sent is :↑↑"
120 print"ffsk      1101001110 ↑↑"
130 print"0 frequency = 1/2 period 300 hz↑↑"
140 print"1 frequency = 3/2 periods 900 hz↑↑"
150 r=3;q=1;qm=1:gosub30000:rem ffsk
160 r=4;q= 900;q=1:gosub30000:rem "1"frequency=900hz
170 q=300;q=0:gosub30000:rem "0"frequency=300hz
180 r=7;qm=1;q=1;q=0:gosub30000:rem 1/2 period ="0"
190 q=3;q=1:gosub30000:rem 3/2 periods ="1"
200 r=8;q=1500:gosub30000:rem outputvoltage=1500mv
210 r=21;q=0;qm=1:gosub30000:rem binarycode
220 r=23;q#="1101001110":qi=200:gosub30000:rem block
230 r=26;q=200;q=1;qm=1:gosub30000;q=0:gosub30000
240 r=20;q=1:gosub30000:rem encodertelegram noi
250 print"for starting telegram press one key"
260 geta#:ifa#=""then260
270 r=2;q=1;qm=1:gosub30000:rem start
280 goto 260

```

FIG 11 User program made up from Data-transmission Software SCUD-K2: it is extremely simple to compose a telegram to special requirements (program lines 120 to 240) and to start it (line 270).

Cellular radio

Cellular-radio networks are presently being put into operation or will be introduced in the near future in many countries all over the world. The function of the different systems is based on a more or less elaborate signalling procedure, which ensures a high level of accessibility to the subscribers and optimal transmission quality. All these networks feature a cellular structure; however, content and sequence of the telegram acknowledgement, redundancy and error correction as well as the type of modulation (FSK, FFSK, PSK, DPSK) are significantly different in the various cellular networks. Thanks to its flexible design as a universal, programmable generator/analyzer for radio-data signals, the SCUD is ideally suited for testing mobile stations of the different radio networks.

The optional Cellular-radio Duplex Modem SCUD-B1 permits bidirectional data transmission in full duplex operation between test assembly and mobile phone. This option contains special program packages based on the general Radio-data Software SCUD-K2 which take account of the particular features of the network concerned and the often extremely complex signalling protocols, and also control the operation of the SCUD in conjunction with the associated Mobile Tester SMFP 2 and Duplex Deviation Meter SMFP B41/B91. This configuration as the basic equipment simulates the base station in the cellular networks AMPS (Advanced Mobile Phone Service), TACS (Total Access Communication System) and NMT (Nordic Mobile Telephone) and, in addition to call



FIG 10 User-specific software controls SCUD for BOS applications.

Operation radio data

The Data-transmission Software SCUD-K2 is supplied as standard for controlling the determination of telegram structure, the genera-

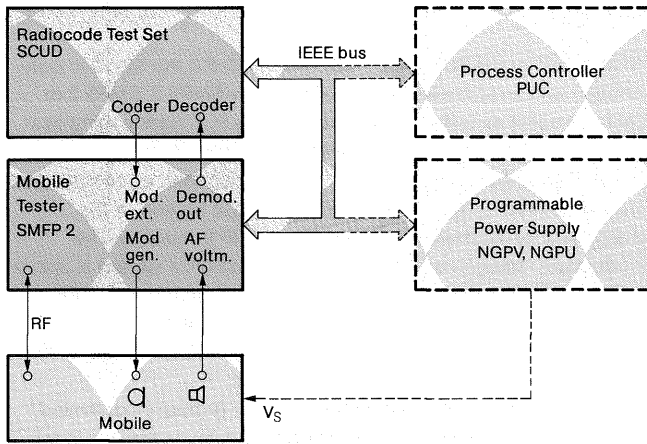

FIG 12 Simple configuration of test system: Mobile Tester SMFP 2 – with duplex deviation meter – and Radiocode Test Set SCUD for all measurements (RF, AF, DC and signalling) on mobile stations of cellular-radio networks AMPS, TACS and NMT.

origination and termination and testing of the signalling procedure (channel change, power change, etc), is also able to carry out all RF, AF and DC measurements (FIG 12).

For testing mobile phones of cellular networks which do not require full duplex working on the signalling section, the **Software Packages SCUD-K3 for NMT, SCUD-K4 for AMPS and SCUD-K5 for TACS** are available, featuring characteristics similar to that of the SCUD-B1 option.

For the automatic execution of comprehensive test routines use of the Process Controller PUC or PCA 5 is recommended. The **programmable Power Supplies NGPV or NGPU** (shown dashed in test setup in FIG 12) are especially suitable for the mobile stations.

In each case the test assembly simulates the base station of the particular cellular network and thus allows **complete testing of the mobile phone**. The software generates and analyzes the telegrams in the SCUD that are required for call origination and termination as well as for channel and power change **in line with the standard specifications**, and takes account of the network-specific type of modulation and the redundancy generation required in the particular system (FIGs 13, 14 and 15).

All signalling parameters, such as call number, channel number, country and/or area code, transmitter power level, etc, can easily be entered into the SCUD via the softkeys and the keyboard. The call origination, termination or transfer of any other telegrams desired can simply be called up at a keystroke. The possibility of error implantation allows checking of the error-correction facility of the mobile phone.

When the softkey ORIG (origination) is pressed, the SCUD inserts the input parameters into the signalling telegrams within a minimum of time and offers in the next menu call origination (mobile to base station or vice versa), measurement of acknowledge delay and roaming updating. With the possibility of selecting the country, the SCUD takes account of **country-specific modifications**.

For evaluation of telegrams the SCUD not only displays the **telegram content in clear text**, but analyzes the information bit by bit and therefore also displays synchronization block, dotting sequence, area code or each individual word. In this way errors are recognized, which in practical operation (shadowing, external

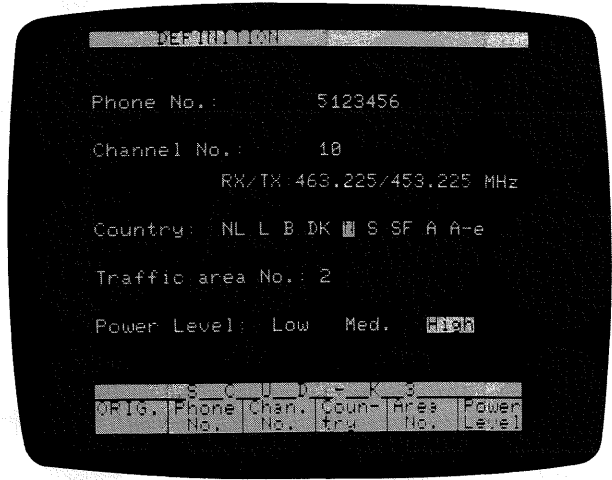

FIG 13 Basic entries on SCUD shown for NMT network.

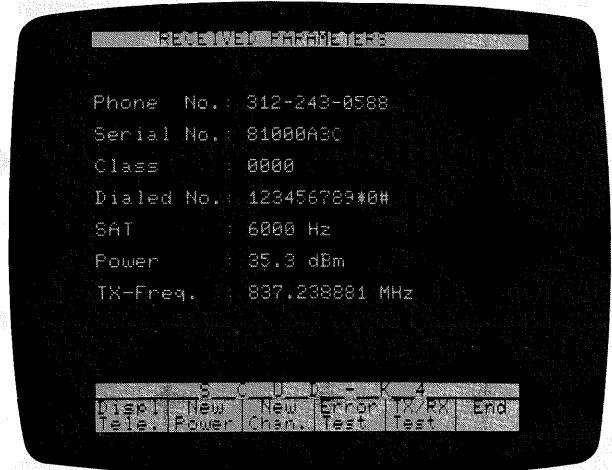

FIG 14 Telegram sent by mobile phone (here: AMPS) is decoded in SCUD. It contains phone number, serial number and class of subscriber's phone as well as selected information sent by mobile phone. SAT frequency, RF power and frequency of mobile phone are displayed on screen as actual values measured.

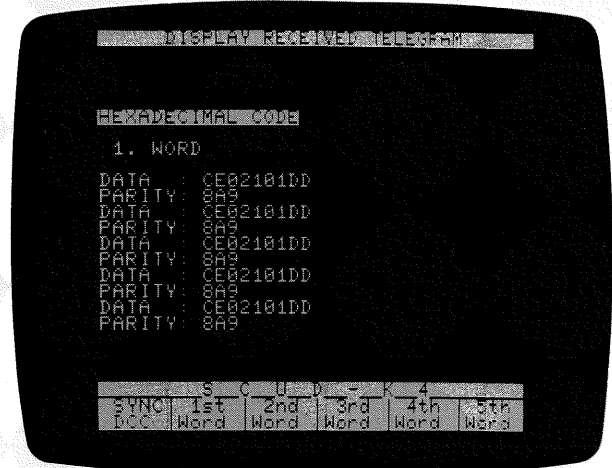

FIG 15 Telegram sent by mobile phone (here: TACS) can be displayed on screen bit by bit. Telegram parts of secondary importance such as header or five-fold telegram repetition used in TACS can thus be checked for accuracy.

interference) could be corrected by the base station with the aid of the system redundancy, but this would unnecessarily load the error-correction facility.

A great advantage of the cellular-radio test assembly is the undiscerned automatic control of the SMFP 2 by the SCUD to enable **realtime working under all operating conditions**. Irrespective of the available routines, the user can set up test routines according to his requirements and simply integrate them into the test programs thanks to the controller capabilities of the SCUD.

Even the test sequencing and program writing for automatic test systems using an external process controller are simple, since for **time-critical and complex routines** the SCUD will take over control of the Mobile Tester SMFP 2 upon a corresponding instruction and afterwards return control to the external process controller (FIG 16).

Additional information on measurement capabilities, applications and operation can be found in the article "Cellular-radio test assembly for AMPS, TACS and NMT" from page 58 onwards.

POCSAG

With the aid of the **Software Package SCUD-K6** the SCUD in conjunction with a radiotelephone test assembly SMFP 2, SMFS 2 or CMT can solve all tasks associated with the **POCSAG** paging system (Post Office Code Standardization Advisory Group).

In contrast to the cellular-radio networks described up to now, data are transmitted **unidirectionally** from the base station to the individually addressable receivers on **one** RF frequency. The modulation voltage carrying the address and data stream is approximately squarewave (direct carrier shift); it is generated in the SCUD **taking into account system-specific parameters** and is applied to the test assembly as an external modulation signal for testing and operation of POCSAG receivers.

With screen-prompted manual operation or program-controlled, the parameters required for information transfer to the pager are entered: the 7-digit identity number, the telegram content, which can be transmitted optionally in binary, ASCII, hexadecimal or user-specific code, and the function code for the call tone. In addition the SCUD-K6 Software offers **many possibilities of parameter entry for testing**: for instance synchronization word, preamble, transmission rate and redundancy-generating polynomial can be entered without conforming to the specifications.

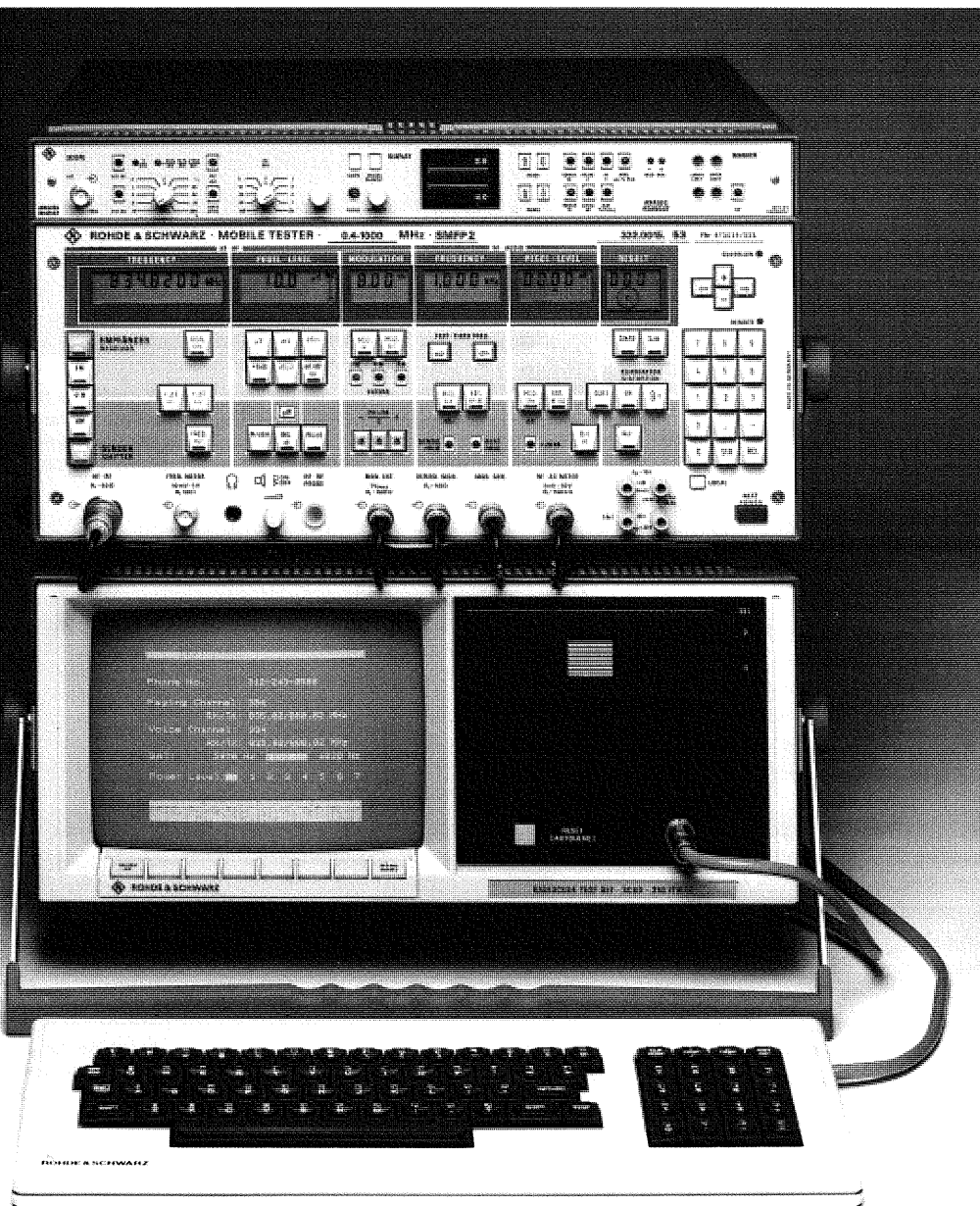

FIG 16 Radiotelephone test assembly consisting of Mobile Tester SMFP 2 with Duplex Deviation Meter SMFP B41/B91 and Radiocode Test Set SCUD for complete testing - RF, AF, DC and signalling - of mobile stations in cellular-radio networks AMPS, TACS and NMT.

For troubleshooting it is also of benefit that data transmission can be repeated automatically for a specified time or number of runs.

Up to six telegrams can be stored in the memory of the SCUD and recalled by the user at any time. If more storage capacity is required for telegrams and parameter configurations, the **disk operating system** will provide further aid.

Further applications

Apart from its use as an encoder for selective-calling and data transmission signals, the **AF synthesizer** integrated in the SCUD – featuring a **wide frequency range** (20 Hz to 25 kHz) and **low inherent distortion** – can be operated as a **stand-alone AF signal generator**. It is an ideal supplement to all radiotelephone test assemblies for the simultaneous and independent generation of signal and pilot-tone modulation, eg **subaudio tones**, free tones or monitoring tones in cellular-radio networks (FIG 17), or general two-tone signal generation (SSB applications).

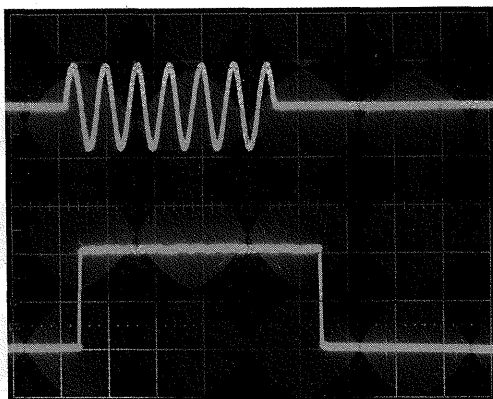

FIG 17 Simple checking of subaudio or pilot-tone decoders with great test depth by means of freely programmable burst, frequency and amplitude.

**Top: sinewave burst generated by SCUD.
Bottom: detector output signal.**

The free programmability of frequency and amplitude and the possibility of generating any signal sequences provide optimal conditions for all investigations of nonlinear components and modules such as frequency detectors, rectifiers and modulation limiters. Of special interest is use of the SCUD for **measurements on noise-suppression systems**, in which the free programmability is a decisive factor. The possibility of frequency variation in any steps within a burst is of great benefit. It allows the decoder of the SCUD to exactly determine the characteristics of the **attack and response times** (the criterion is the varying frequency). With the aid of the **selective-call software package** such signals can be generated and analyzed in the manual mode without elaborate programming.

Use as process controller

The process controller integrated in the SCUD can of course also be employed as a self-contained unit without making use of the SCUD-specific characteristics. In its functions it is comparable to

the Process Controller PUC and, in addition to use as a universal desktop computer, is also ideally suited for the configuration of automatic, computer-controlled test systems using suitable interfaces and available options.

Options

In addition to the optional Cellular-radio Duplex Modem SCUD-B1 many other options allow economical adaptation of the SCUD to specific measurement tasks. The **Input/Output Interface PUC-B7** with 32 programmable TTL lines, seven relays, an A/D and a D/A converter is ideal for use in automatic test assemblies. Switching of call numbers, control of modules and whole radio sets as well as the function as a **signal scanner** can then easily be integrated in the automatic measurement process. The options of the Process Controller PUC – high-resolution graphics, realtime clock, RS 232 C interface and second floppy-disk drive – are available as further accessories.

CONDENSED DATA RADIOCODE TEST SET SCUD

AF synthesizer	frequency 20 Hz to 25 kHz, level 0 to 2000 mV
Selective-call encoder	standards (ZVEI 1, ZVEI 2, CCIR, EEA, EIA, CCITT, VDEW, NATEL, EURO), 14 freely programmable sequences of 15 frequencies each, tone sequences of 1 to 15 tones from the sequences, tone duration and pause duration from 0.2 to 3000 ms
Selective-call decoder	evaluates calls of up to 37 tones, measures frequency and voltage of each tone, measures tone duration and pause duration, sets tolerances for frequency, tone duration and pause
Radio data	modulation: FSK, FFSK, PSK, DPSK 0, DPSK 1, block-oriented telegram structure, 9 different codes, automatic redundancy generation, evaluation of telegram content, marking of content errors, measurement of frequency, voltage, transmission rate and acknowledge delay
Cellular radio	signalling to AMPS, TACS, NMT specifications; with option SCUD-B1 suitable for full-duplex working, matched to Mobile Tester SMFP 2 for complete radiotelephone testing (RF, AF, DC, signalling)
POCSAG	universal software package for transmission of alphanumeric telegrams to POCSAG specifications
Process controller	universal process controller with built-in floppy-disk drive, IEC/IEEE bus and printer connector, softkeys, detached keyboard, Basic programming language and machine language; further characteristics comparable to R&S Process Controller PUC
Ordering number	393.7110.02

A comprehensive test on mobile stations of the cellular-radio networks AMPS, TACS and NMT includes very complex test routines, mainly in the field of signaling. Rohde & Schwarz provides a suitable test assembly consisting of Radiocode Test Set SCUD, an intelligent generator/analyzer for radio data, and Mobile Tester SMFP 2, a radiotelephone test set. This assembly is in use with leading equipment manufacturers and PTT administrations all over the world.

Cellular-radio test assembly for AMPS, TACS and NMT

FIG 1 Automatic test assembly for mobile phones of cellular-radio networks AMPS, TACS and NMT, consisting of Radiocode Test Set SCUD and Mobile Tester SMFP 2 with Duplex Deviation Meter SMFP B41.



All mobile telephone systems that are presently being introduced are configured on the principle of cellular-radio networks. The entire area to be covered by a radio network is divided into cells. The frequency- and time-occupancy plan of any one cell differs from that of all neighbouring cells, but is reused in more remote cells. This principle allows a large number of subscribers using relatively few frequencies. An elaborate data-telegram exchange between base station and mobile ensures smooth radio traffic, but also requires complex test procedures and test assemblies which must optimally meet the exacting requirements (FIG 1).

The content of the exchanged data telegrams not only consists of the dialed number, but also of country, area and location codes. In addition it contains information about the quality of the existing radio link and about any forthcoming change in channel or transmitter power. This makes for a high level of accessibility of the subscribers within the whole area and good transmission quality combined with efficient frequency occupancy of the cellular-radio network (FIG 2).

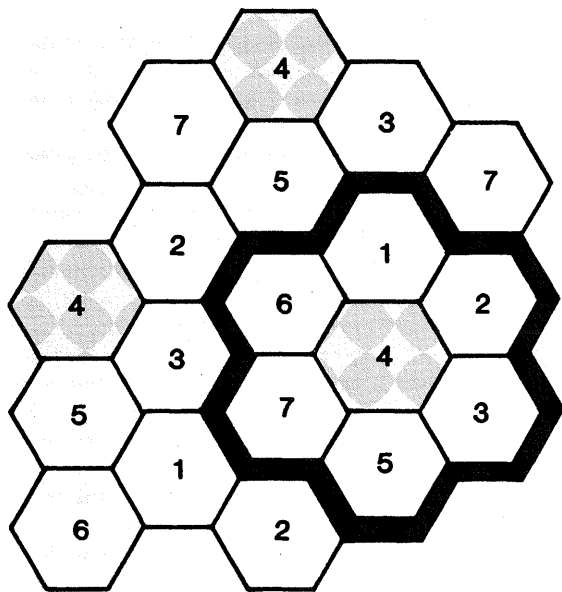

FIG 2 Principle of modern cellular-radio networks. Same frequency is reused in cells with same number to make most of low number of transmit/receive channels available.

TABLE Modern cellular-radio networks and countries of use.

System	Introduction in	Discussed for	Coding method	Transmission speed
AMPS Advanced Mobile Phone Service	USA, Canada		PSK	10 kbit/s
TACS Total Access Communication System	UK		PSK	8 kbit/s
NMT Nordic Mobile Telephone	Denmark, Sweden, Finland, Norway, Austria, Netherlands, Switzerland	Saudi Arabia, Spain, Malaysia, Thailand, Belgium, Luxembourg, Tunisia	FFSK	1.2 kbit/s
Network C	Federal Republic of Germany	South Africa	direct carrier keying (NRZ)	5.28 kbit/s
CD 900		Federal Republic of Germany, France	probably fully digital	not yet specified
Radiocomm 2000	France		FFSK and FSK	1.2 kbit/s and 50 bit/s

The size of the cells and the number of channels are matched to the volume of the radiotelephone traffic (town, country) and topography. Content and sequence of the telegram acknowledgement procedure, redundancy, error correction and the type of modulation (FFSK, PSK, DPSK) differ significantly in the various cellular networks.

Thanks to its flexible design as a universal, programmable radio-data generator/analyzer the SCUD is ideally suited for testing mobile phones of the radio networks AMPS (Advanced Mobile Phone Service), TACS (Total Access Communication System) and NMT (Nordic Mobile Telephone) including all modified versions of them for different countries (TABLE).

Two different configurations are possible for the SCUD. The software packages SCUD-K3 for NMT, SCUD-K4 for AMPS and SCUD-K5 for TACS are available for radio sets which do not require full-duplex data traffic (these being in the majority). The optional Cellular-radio Duplex Modem SCUD-B1 with software packages for all three networks is available for more in-depth testing and for radio sets which require full-duplex operation.

In any case the software packages take account of the particular features of the individual networks including special-to-country modifications as well as the often very complicated signalling protocols. They control, unnoticed by the user, the operation of the SCUD in conjunction with the associated Mobile Tester SMFP 2 with Duplex Deviation Meter SMFP B41/B91. This basic configuration of a cellular-radio test assembly simulates the base station in such a network and, in addition to the call origination and testing of the signalling procedure, it is able to carry out all RF, AF and DC measurements on the radiotelephone set proper. Besides the universal capabilities of the SCUD, the superior measuring quality of the SMFP 2 is outstanding in all measurements on radio sets and their modules. The SMFP 2 has all the necessary measuring facilities for complete radiotelephone testing with high accuracy and wide dynamic range, some special features making it ideally suited for use on mobile stations of cellular-radio networks. These include a presettable Duplex Deviation Meter (option SMFP B91 or SMFP B41), which operates independently of the internal RF synthesizer and features a wide demodulation-frequency range, extremely fast settling time and extraordinarily low residual FM. Its

quality makes for the exact recording of transmitter parameters such as modulation, S/N ratio and modulation distortion. An important feature is the capability for internal two-tone modulation for simultaneous but independent generation of useful modulation and the necessary monitoring tones (NMT 4 kHz, AMPS/TACS 5.97, 6 or 6.3 kHz SAT tone).

In the testing of a mobile radio, the SCUD handles the signalling (generation and evaluation of data telegrams) and the SMFP 2 all transmitter and receiver measurements. A distinction is made between two testing modes, the service mode and complete system test.

Testing in service mode

For this test the mobile radio is set to the various operating modes (transmit, receive, channel selection, power level, etc) from the keypad of the control unit or, if equipped for this purpose, by means of specific data telegrams directly via the RF. If the built-in, optional Input/Output Interface PUC-B7 is fitted with a suitable connector (eg AMPS), it allows setting to the desired operating mode by serial or parallel binary data transfer. The SMFP 2 then performs all necessary measurements on the radio such as sensitivity, modulation, frequency response, transmitter power and S/N ratio.

Complete system test

For the necessary complete system test (transmitter, receiver and control unit), which is also of much greater interest, including the signalling procedure (call origination and clearing, data exchange) the SCUD and SMFP 2 work together as an IEC/IEEE-bus test system in which the SCUD serves as the controller for the SMFP 2.

Both instruments together simulate the base station and enable call origination and clearing under near practical conditions in realtime simply via the RF path by repeated, automatic exchange of telegrams between the test assembly and the connected mobile station. The SCUD software package controls the generation and analysis of telegrams which are required for call origination and clearing, channel and power change as well as for any further data transfer (FIG 3). The different, network-specific types of

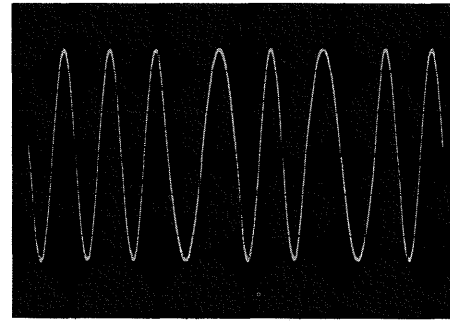

FIG 4 Section of NMT telegram generated by SCUD showing precise frequency change during zero-crossing (logic 1 = 1 period 1200 Hz, logic 0 = 3/2 periods 1800 Hz).

modulation and the redundancy generation and evaluation required in the particular system are automatically taken account of.

Measurement of response time (nominal value 30 ± 2.5 ms) after a mobile has been called by the base station – one of the most important parameters in the NMT system – is only one example of the many further possibilities of measurement and data transfer. With the aid of the directly addressable routines in the software package the user himself can easily generate any telegrams and integrate them into a test program. In telegram generation the redundancy is produced automatically and in line with network standards by restructuring the data and is also accounted for during evaluation. Special routines are provided for checking the ability of a mobile radio to correct transmission errors occurring in practical operation. During continuous telegram transfer they increase the number of bit errors artificially implanted and displayed by the SCUD until the mobile phone refuses acceptance. It is also possible to implant errors at specific points in the telegram. In generating the telegram the SCUD produces a very precise burst of oscillations (FIG 4). Frequency, amplitude, phase and frequency transition are exactly defined and the signal starts, stops and changes frequency or phase precisely on the zero-crossing points of the waveform (SCUD-K3/K4/K5) or it is sent by the optional Cellular-radio Duplex Modem SCUD-B1. This option allows simultaneous generation and evaluation of data telegrams in full-duplex operation via two independent generator memories and one data decoder.

The SCUD thus recognizes incoming telegrams in realtime operation and allows uninterrupted change of telegrams at the encoder. These two features ensure fastest response of the complete test

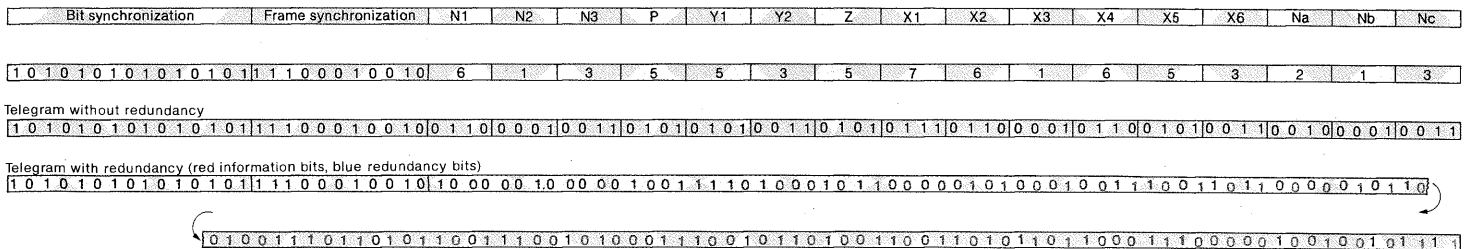
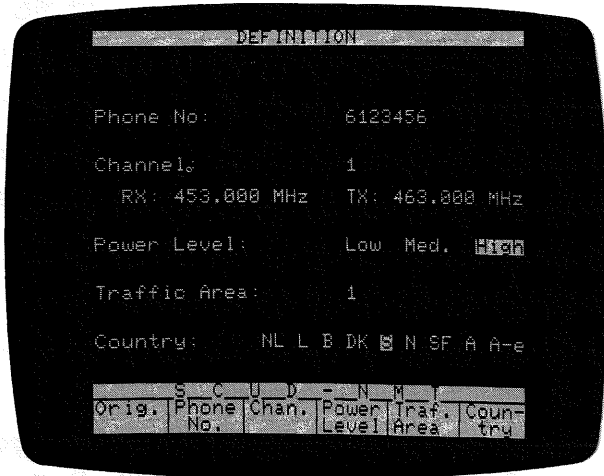
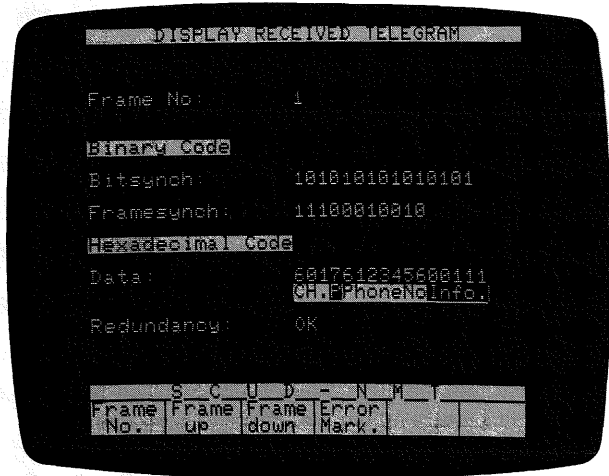

Fig 3 Transmitter-power change telegram as example of telegram structure used in NMT. SCUD automatically generates telegrams according to system standard and adds necessary redundancy. User only has to enter subscriber number and power level required. Sections of telegram in this example are: N₁ power level (6 high power), N₂, N₃ channel number (1,3 channel 13), P telegram identification (5 traffic-channel allocation on traffic channel), Y₁ country code (5 Denmark), Y₂ area code (3 area 3), Z country code in subscriber number (5 Denmark), X₁ through X₆ subscriber number (761653), N_a new data for N₁ (2 low power), N_b, N_c new data for N₂, N₃ (1,3 channel 13).



Basic entries for call setup shown for NMT: simple entry of channel desired for call setup, call number and required transmitter power level of mobile phone. Country code and traffic area as line code may be entered as desired. Next routine for triggering call setup is called up by ORIGINATION key.



Analysis of received data stream at bit level: bit synchronization and frame synchronization as well as telegram content are displayed for each telegram frame. Additional display of information whether received redundancy bits are correct or faulty. If received bit does not agree with expected bit, ERROR MARK softkey outputs error mark for each bit instead of frame content.

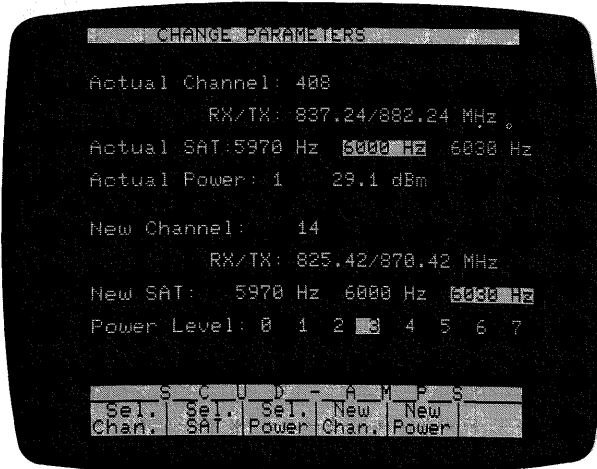

Cellular-radio networks differ significantly in structures and signalling procedures. In spite of these differences network-specific SCUD software packages are very similar in maximum ease of operation. Example shows operating routine for channel and/or power change in AMPS.

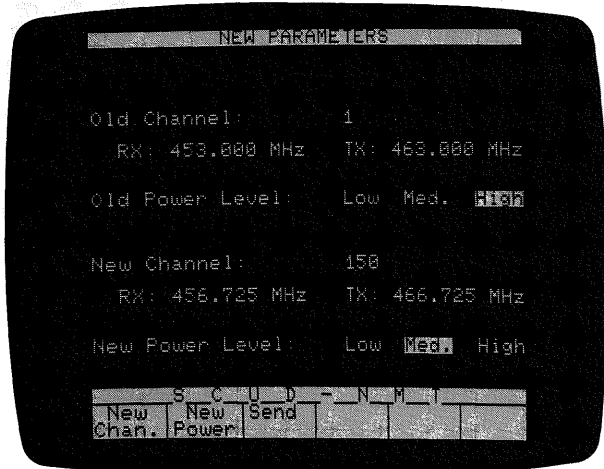

Power and/or channel change shown for NMT: after entering parameters of new traffic channel (channel number, power level), power and/or channel change is executed upon keystroke. After completed change, received data telegram is displayed in go/nogo test or down to bit level and signal parameters such as transmitter frequency and transmitter power are read out as actual values measured.

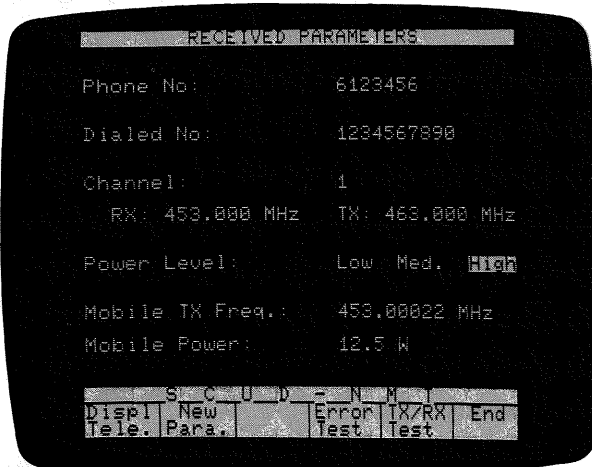

Display of mobile-phone data derived from telegrams at go/nogo level, shown for NMT: test assembly determines from received data phone number of mobile phone, dialed number, traffic channel used and power level used. For monitoring purposes, transmitter frequency and transmitter power of mobile phone are additionally displayed as actual values measured. Further operating routines are called up via softkeys: analysis of data stream at bit level, power and channel change, checking of error-correction facility, measurement of RF and AF characteristics of mobile phone, drop-off of radio link.

FIG5 Convenient user prompting via softkeys greatly facilitates entry of comprehensive system parameters, call setup and any further signalling procedures as well as display of telegrams sent by mobile phone. This holds for simple go/nogo statements through to analysis of every single bit.

set in **realtime working** under all operating conditions. For each command in the test program the time of execution is measured and made available if called up. The duplex modem thus also enables **time measurements of signalling procedures**.

The telegrams sent by the mobile phone are automatically analyzed bit by bit in the SCUD and directly displayed on the screen in **clear text**: dialed call number, subscriber and serial number of the mobile phone, class of the mobile radio, etc. In further in-depth analyses, telegram headers such as **dotting sequence** or **synchronization block** as well as the content of every single word transmitted are displayed. In this way errors are recognized which, although they could be corrected by the base station, would unnecessarily load the error-correction facilities of a radio network and thus reduce the successful call rates in practical operation. The screen displays in FIG 5 illustrate some of the **conveniences** of the SCUD.

When called up in the program, the call origination between the SCUD plus SMFP 2 and the mobile station is performed fully automatically by the required multiple exchange of telegrams, taking account of the network-specific timing. The **threshold for a successful call** is determined by repeating the call procedure several times while varying the RF output level of the SMFP 2. Repeating the call origination at the sensitivity limit of a mobile phone provides information on the **probability of a successful call**, which is an important quality criterion.

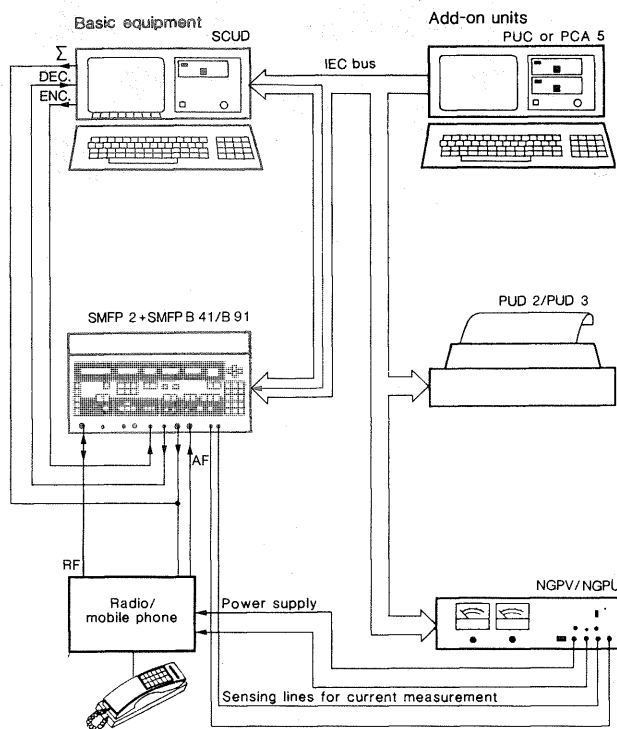

FIG 6 Fully automatic assembly, eg for testing mobile stations of cellular-radio network. Suitable add-on units for basic configuration (Mobile Tester SMFP 2 with Duplex Deviation Meter SMFP B41, Radiocode Test Set SCUD) are Process Controllers PUC or PCA 5, Universal Printers PUD 2 or PUD 3 and programmable Power Supplies NGPU and NGPV.

Operation

In spite of the partly different telegram structures in the individual channels (paging and voice channel), the system parameters to be additionally transmitted (overhead message, roaming updating) and the complex call origination by multiple telegram exchange, operation of the cellular-radio test assembly (FIG 6) is still extremely simple, since all the activities required for telegram generation, telegram evaluation, timing and the settings of the radio test assembly are performed fully automatically by the SCUD. The different modified versions for various countries (NMT) have been taken account of in the software packages.

The **user prompting on the screen** in conjunction with the relevant labelling of the softkeys ensures rapid, **errorfree access** to the desired test routine. The choice between semi-automatic, manual operation – ie fully automatic signalling by the SCUD and manual measurement of the RF, AF and DC parameters with the SMFP 2 – and fully automatic operation under programmed control via IEC/IEEE bus from an external processor (eg Process Controller PUC or PCA 5) ensures **economical use** in all fields of radiotelephone testing:

- development,
- quality assurance,
- production,
- acceptance,
- approval,
- servicing.

As a result of the controller function integrated in the SCUD, no external process controller is required for simple, program-controlled measurements; the basic software even allows configuration of completely different signalling procedures or modification of the existing ones simply by calling up routines. The process controller contained in the SCUD also plays an important part in computer-controlled operation: for **time-critical procedures** it takes over control of the radiotelephone test assembly and after execution automatically returns control to the external process controller.

In addition to the great variety of applications described above, the SMFP 2/SCUD test assembly also allows testing of **radio-equipment modules** such as modulators, demodulators, modems or internal background intelligence (μ P). The Input/Output Interface PUC-B7 with parallel or serial data transfer to the test item, available as an option for the SCUD, is a valuable aid in setting up test items.

The test assembly is of course also suitable for testing other products than those of cellular radio, **economical use of the test assembly** being ensured by the process controller fitted as standard and various software packages.

For network C in the Federal Republic of Germany a special model of Radiocommunication Tester CMT is available. The generator/analyzer for radio data is already integrated in this radiotelephone test assembly. There are no IEC/IEEE-bus transfer times, so this test assembly meets the time criteria of a fully synchronous network in a special way and thus allows simulation of a base station in realtime working.

Michael Vohrer

The network-C model of the Radiocommunication Tester CMT is a low-cost, compact test set which ideally combines extraordinary efficiency in analog transmitter and receiver measurements with the capability of testing a network-C radiotelephone for system conformity and performance characteristics.

Measurements on network-C radiotelephones using Radiocommunication Tester CMT

The aim of the new West-German car-telephone network C is to offer the customer as far as possible the same convenience as he or she is accustomed to from the wired telephone network. To achieve this goal, essential basic requirements have to be fulfilled. Communication between wired and radio telephone subscribers or vice versa and between mobile phones must be established **fully automatically** and accessibility to mobile-phone subscribers has to be ensured within the country **irrespective of whereabouts**. Speech quality must not be affected even during lengthy calls under varying radio conditions. Suitable devices must be provided to ensure secrecy of telecommunications and to avoid evasion of charges by misuse.

Meeting these requirements in view of the limited frequency bandwidth of 222 radio channels for some 100,000 to 250,000 subscribers and under the much less stable conditions of radiocommunication calls for a high-performance and complicated system con-

figuration with a lot of special features far beyond the usual demands in radiocommunication. High demands are therefore also made regarding the measuring equipment, including, for instance, the **necessity of simulating a base station** with all its essential characteristics. The network C model of the Radiocommunication Tester CMT is able to fulfil all these requirements (FIG 1).

Network-C characteristics

Like other car-telephone systems, network C operates on the cellular-radio principle. The frequency- or time-division-multiplex occupancy plan of any one cell differs from that of all neighbour-

FIG 1 Radiocommunication Tester CMT simulates in network C essential characteristics of base station and is thus able to measure signalling, RF and AF parameters of network-C mobile phones.

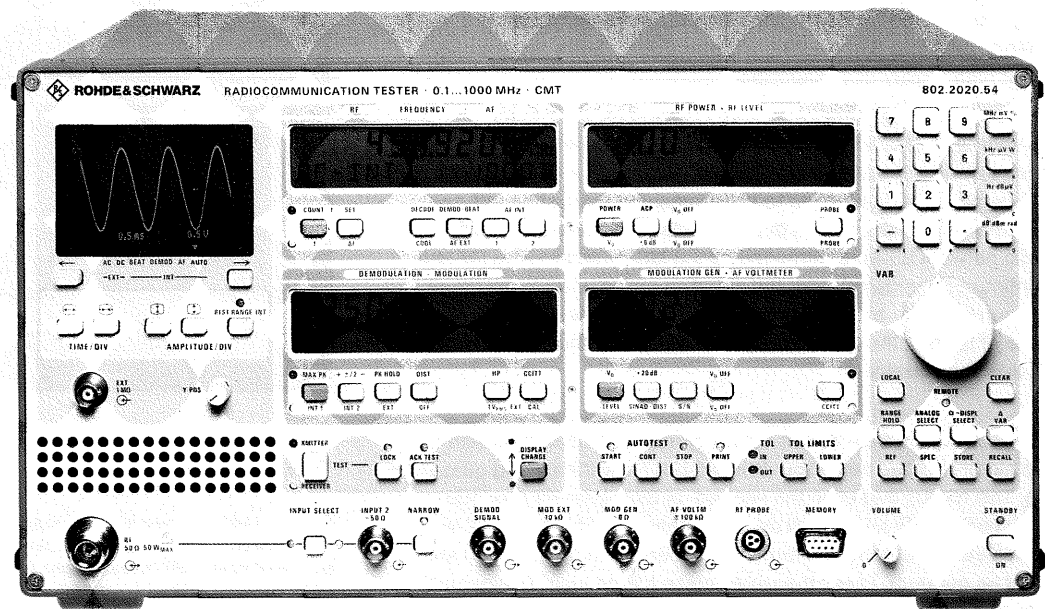

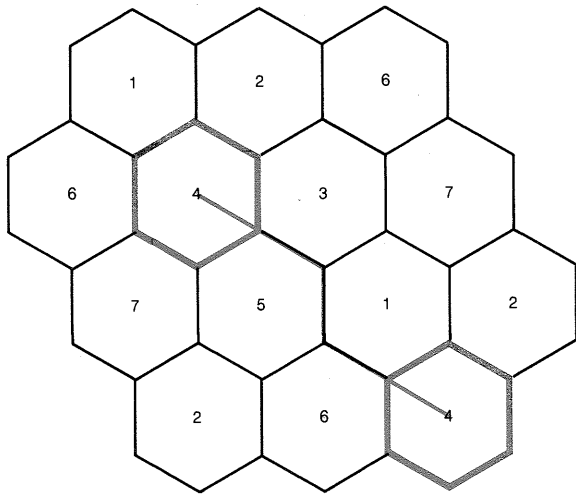

FIG 2 Distance between cells having same number is about five times cell radius. Due to this large distance, base stations in cell centre may use same time slots in control channel and same frequencies in speech channels. All neighbouring cells have different numbers and also occupy different time slots and channel frequencies.

ing cells and is only repeated in remoter cells at a distance of about five times the cell radius (FIG 2). This allows a large number of subscribers using relatively few frequencies. For the transmission of call-processing data one **control** or organization **channel** is normally provided. It operates in time-division-multiplex mode, whereas all the speech channels use frequency multiplexing.

All network-C base stations or radio concentrators, in the following referred to as BS, use the same frequency for the control channel, the same time slot being allocated to all BS with the same cell number (FIG 2). This time-division method calls for **synchronization** of BS and MS (mobile stations) **throughout the network**, covering the time-division clock, the data-transmission clock and the RF. This overall synchronization allows the MS to measure the relative distance to the surrounding BS by **phase comparison of the data clocks**. In conjunction with an **S/N ratio measurement** of the data signals sent by the BS (jitter), the MS is provided with a criterion for selecting connection to the best accessible BS. Measurements can be repeated even during an existing call, so the MS may – unnoticed by the persons involved in conversation – change over to a BS providing a better signal, thus ensuring **constant high quality of connection**.

As soon as an MS is switched on and the subscriber's ID card has been inserted, the MS participates in radio traffic even without a call being made. In addition to the permanent evaluation of a call that may exist, the position of the mobile subscriber within the radio network is also determined by the MS, entered into a file and continuously updated. With the aid of an active entry in the file of the current radio zone as well as an entry in the file of the home zone of the MS, the system is able to address mobile subscribers all over the country.

Congestions are determined by the system and overcome with the aid of so-called neighbour-to-neighbour assistance and queuing. This means that even the second- or third-best BS may maintain contact with an MS if all available channels of the best BS are occupied (ie call requests from subscribers cannot be fulfilled and must be queued). These measures make for the high obtainability rate in network C.

As already described, data are also transmitted between BS and MS during a call. This data flow has the following tasks:

- identification of current call, in particular as protection against evasion of charges by misuse,
- transmission of call-charge count to MS,
- permanent monitoring of call quality to enable switchover to another speech channel or radio zone,
- variation of transmitter power of BS and MS.

Data are inserted in a call unnoticed by the participants, using **time compression of the speech signal by 1/11** and inserting the data into the resulting interval. At the receiving end the **compound signal is expanded** so that in addition to the data, the speech signal is also available in its original form (FIGs 3 and 4). For separa-

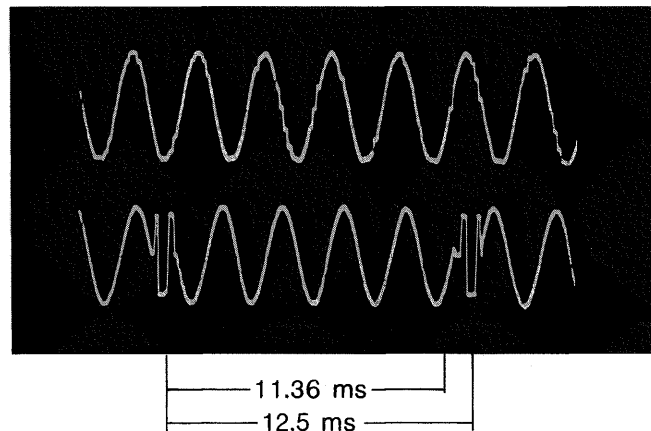

FIG 3 Test tone of 600 Hz frequency (upper trace) is output at 660 Hz and stopped after 11.3636 ms for 1.1363 ms with constant phase. One pause bit, four data bits and again one pause bit (lower trace) are inserted in this interval, thus allowing data to be inserted into compressed speech.

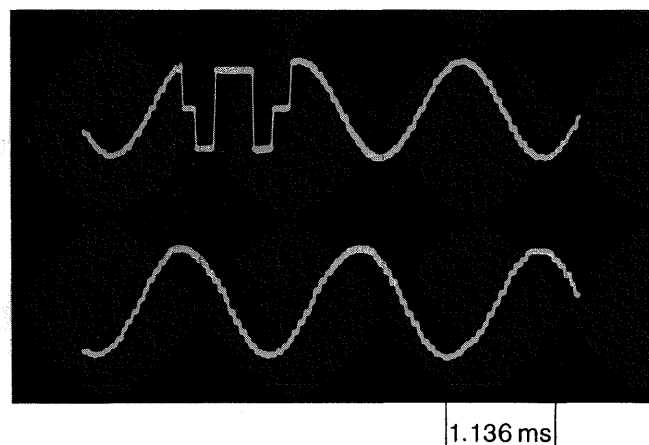

FIG 4 Using network-synchronous data clock, compressed signal with inserted data (upper trace) is buffered, expanded and output without phase shift (lower trace). Extracted data are further processed, while expanded signal is measured. Compression and expansion delay signal by 1.1361 ms.

tion of voice and data, the time compression and expansion facilities require the kind of timing that is only possible in a fully synchronized system such as network C.

Measurements on network-C mobile stations

Compared to "normal" RT measuring equipment, a test assembly for a network-C mobile phone must be tailored to specific measurement needs. For instance, an **automatic test sequence** for standard procedures already provided in the test assembly is mandatory, since signalling protocols and channel changes occur in an **accurately defined sequence**; manual settings are not possible at all.

The fully synchronized network requires from the test assembly that any actions (eg data-telegram exchange) be performed with **timing accurate to microseconds**. The demands placed on the timebase of the test assembly are correspondingly high.

The burst signalling mode, in which data are distributed into the slots produced by compression, is not possible with conventional test facilities. Although it is relatively easy to simulate a time-compressed test signal, such a signal is very difficult to separate from the data and to expand. After time expansion the analog signal component must be accurately measured (deviation, SINAD), whereas the data must be retrieved from the slots for further processing.

The ability of an MS to choose the better BS requires the test assembly to simultaneously simulate two or more BS in one control channel, which means that **data telegrams of different contents** must alternate. At the same time varying radio-transmission conditions must be simulated for the BS.

The different distances to two BS result not only in different field strengths but also in group-delay differences, which are recognized by the MS. The test assembly must produce these group-delay differences with the aid of **accurately defined phase shifting** of the two BS signals. If the phase position varies irregularly, the MS determines the **jitter**, which is also used as a criterion for evaluation of the radio signal. Producing this jitter is a further task of a network-C tester.

In addition to the requirements specific to network C, the tester must also meet all the other demands placed on normal RT test assemblies:

- RF and AF full-duplex capability,
- fast RF frequency settling in transmitter and receiver testing,
- performance of any analog measurements on transmitters and receivers, such as frequency, power, deviation and distortion measurements (transmitter testing) or AF voltage, S/N and SINAD measurements (receiver testing).

CMT in practical use

The network-C-compatible model of the Radiocommunication Tester CMT contains all measuring and control facilities necessary to perform the tasks described above. As is usual with mobile phones of cellular-radio networks, the network-C phone only allows analog transmitter and receiver measurements under practical conditions when it has been set to speech-channel mode with the aid of data telegrams and is kept in this mode by data telegrams continuously nested in the analog test signals.

On the one hand the CMT provides for continued operation, while on the other it measures the AF voltage, distortion, SINAD or AF response of the MS in the receiver test. An S/N measurement provides information about receiver sensitivity. The transmitter test can only be carried out because of the **full-duplex capability of the CMT**, since the MS can only be held in transmission mode over a lengthy period after a receive signal has been applied. In this mode the following transmitter measurements can be performed: RF power, transmitter frequency, useful modulation as a function of AF frequency and microphone voltage, as well as **spurious modulation**. The modulation distortion and the frequency of the demodulated signal are of particular interest because of the time compression carried out in the MS.

Adjacent-channel power is of similar interest, since compared with a continuous test tone data transmission is more liable to produce spectral lines in the adjacent channel.

The focal point of network-C measurements therefore is the data dialog with the mobile phone, simulated by the CMT with different signalling protocols in different time slots of the control channel. In the control channel the CMT provides the time-division clock, whereas in the speech channel it uses its full-duplex capability to control concentrated signalling. In the burst-signalling mode it sends time-compressed test tones provided with data to the MS and separates call tone and data from the MS signal via the built-in time-expansion facility.

In the following, standard routines are described which are used for checking an MS for **conformity with network C**.

Registration

The CMT operates as a BS sending data in one of the 32 time slots of 75 ms each. If any step of the data dialog is not successfully completed, it can be retraced on the **alphanumeric display of the CMT** for a certain time from the moment of abortion. Confidential information (eg BS identification) will be blanked due to postal regulations.

Relocation

Proceeding from the registered state, relocation (cell change) differentiates between **BS selection according to RF level or distance**. If RF level is the criterion, the CMT simulates two BS with different RF levels in two different time slots. The levels are selected to allow the BS in which the MS is registered to be operated with low RF levels, while the second BS has a high RF level. This situation causes the MS to make a relocation request to the BS with the

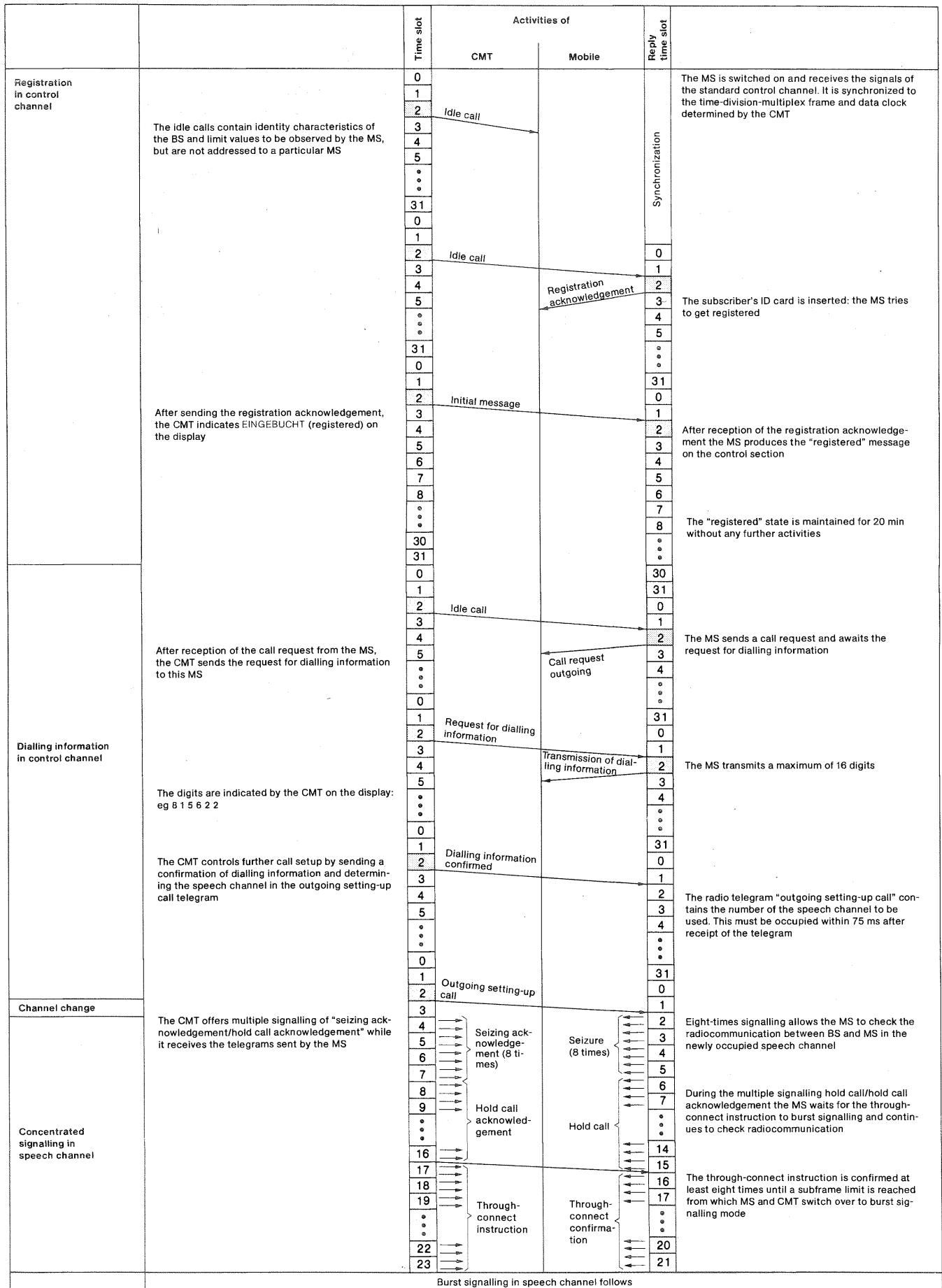

Burst signalling in speech channel follows

FIG 5 Registration takes place in control channel operating in time-division-multiplex mode. Therefore CMT only sends data in time slot 2 and expects response of mobile station in reply time slot. Outgoing call setup (mobile station calls) comprises four main steps. Registration takes place in control channel followed by transmission of dialling information. Data exchange with concentrated signalling takes place in speech channel prior to speech communication proper in burst signalling mode.

stronger signals, whereupon the CMT sends a **monitoring request** in the time slot of this BS. The MS message reply terminates the relocation and the CMT indicates "relocated" (UMGEBUCHT) on its alphanumeric display.

If distance is the criterion for relocation, the procedure differs from that described above in the **phase shift between the time slots** of the two BS, which is used for simulating different distances. The MS responds in the same way as described above.

Call setup

To set up a speech connection, four main steps are required. Starting point is the registered state in the control channel, in which the dialling information is transmitted. BS and MS then change to the speech channel; first only data are exchanged, while the new channel is once more evaluated as to its radio quality. By switching over to burst signalling mode (compressed test tone, interleaved with data) the way becomes free for speech communication.

After switching to burst signalling mode, the CMT maintains this state by expanding the time-compressed signals sent by the MS transmitter, evaluating the data extracted from these signals and providing the MS receiver with acknowledgement data nested into the test tone to maintain the connection. In this state analog RT measurements can also be carried out.

The CMT also offers a standard routine for the incoming setting-up call (the mobile subscriber is called), which is similar to the outgoing setting-up call described above.

Proceeding from the existing speech connection, the CMT is able to cause power change and speech-channel change of the MS and to monitor their execution. With the aid of **errors implanted** into the data telegrams responsible for the power change, the CMT checks the **error-correction capability of the MS**, which should recognize the error and change the power.

Operation

The operation of the network-C tester CMT has been logically designed to allow simple and reliable checking of a network-C mobile phone for conformity with the system and measurement of the essential performance data. Instead of going into the many detailed steps that could be taken in the numerous branches of the routines, priority has been given to the important standard sequences. By simply selecting a standard sequence with the rotary knob, the user employs the network-specific capabilities of the CMT without having to follow the complex signalling procedure. The CMT only requires the necessary parameters for the routine and then automatically performs the signalling with the mobile station. Successful, errorfree execution is confirmed by a message on the alphanumeric display of the CMT, eg "registered" (EINGEBUCHT). If a procedure is unsuccessful, the data dialog until abortion can be displayed, thus allowing troubleshooting.

Fields of application

Due to its **compact design and ease of operation**, the network-C tester CMT is suitable both for mobile and stationary servicing. Using the **optional autorun control/printer interface**, measurements for a complete and automatic radiotelephone test can be combined in one program. This test includes checking of call processing and analog measurements with data logging on a printer, making the CMT ideally suited for routine testing of network-C mobile phones. The **measuring quality** and the **numerous measuring capabilities** known from the basic CMT model are of course fully available and allow versatile use of the tester in mobile and automatic service centres, or for adjustments and final inspection in production.

Thomas Maucksch

In Signal Generators SMG, SMK, SMPC and SMPD Rohde & Schwarz offers four universal signal sources for radiotelephone measuring applications. The balanced graduation according to application focal points and price results in an optimum instrumentation program.

Four for any occasion

Signal generators combined with other measuring instruments are an alternative to complete radiotelephone test assemblies. They are indispensable for selectivity tests in two-signal measurements where the interfering signal outside the receive channel must have particularly high spectral purity.

Signal Generators SMG, SMK, SMPC and SMPD from Rohde & Schwarz (FIG 1) are four particularly interesting instruments for radiotelephone measuring applications. All four are synthesizer-controlled for a crystal-exact output signal and have high resolution of 0.1 and 1 Hz. The IEC 625-1 (IEEE 458) remote-control

interface is standard on each instrument. SMG, SMPC and SMPD cover all important radiotelephony bands.

SMG (0.1 to 1,000 MHz) provides universal characteristics and high ease of operation. SMK (10 Hz to 140 MHz) has particularly good modulation properties. Its principal applications are measurements on shortwave and SSB receivers (aeronautical radio, amateur and maritime radio) as well as broadcast receivers up to the VHF range. SMPC (5 kHz to 1360 MHz) and SMPD (5 kHz to 2720 MHz) exhibit exceptional spectral purity. SMPD enables measurement of spurious responses to over 2 GHz.

FIG 1 The Rohde & Schwarz range of signal generators is the result of many years of experience in producing high-grade synthesizers.



Because of their low values for phase noise and nonharmonic spurious signals, all four instruments are especially suitable for two-signal measurements (determination of adjacent-channel selectivity, intermodulation, desensitization, etc). Signal Generators SMPC and SMPD can be used to determine selectivity properties of receivers far in excess of the values specified by CEPT.

sensitivity with respect to interfering signals. All four signal generators are suitable for this application; SMPC or SMPD should be used to verify particularly high-quality receiver properties. The low SSB phase noise of SMPC and SMPD enables **measurement of dynamic adjacent-channel selectivity at 500 MHz up to above 80 dB**; 70 dB is specified by CEPT for mobile-radio receivers.

	SMG	SMK	SMPC	SMPD
Frequency range	100 kHz to 1000 MHz	10 Hz to 140 MHz	5 kHz to 1360 MHz	5 kHz to 2720 MHz
Resolution	1 Hz	1 Hz	0.1 Hz up to 1000 MHz, 1 Hz above 1000 MHz	0.1 Hz up to 1000 MHz, 1 Hz above 1000 MHz

The high resolution of at least 1 Hz in all four instruments is also suitable for SSB tests. Special synthesis techniques with phase-locked loops and fractional division or digital, crystal-exact signal generation make this possible. Frequency accuracy is determined by the internal crystal oscillator or an external reference frequency. SMPC and SMPD come fitted with highly stable, oven-controlled crystal oscillators as standard; these are available as options for SMG and SMK. Aging is then $1 \times 10^{-9}/\text{day}$ and the frequency error $2 \times 10^{-9}/^\circ\text{C}$.

Settling times

The frequency settling times until the offset from the final frequency is less than 100 Hz are:

- SMG 15 ms
- SMK less than 40 ms

In the case of SMPC and SMPD, the settling times for an offset less than 1×10^{-6} are below 18 ms, and in a **special mode** even **below 7 ms**. The short settling times, which are also below 25 ms for level settings, guarantee short measuring times in computer-controlled test sequences covering a large number of testpoints. They also satisfy the demands for tests on **mobile-radio sets for cellular-radio systems**.

Spectral purity

The decisive factors for spectral purity are **SSB phase noise**, **broadband noise**, **spurious FM** and the **level of nonharmonic spurious signals** (FIG 2, FIGs 3 and 4 on page 70). As a result of the frequency-division principle, the values for SSB phase noise, spurious signals and spurious FM improve in SMG, SMPC and SMPD as frequency decreases (FIG 5 on page 71).

Particularly high spectral purity is required for **out-of-channel measurements**. In such applications the signal generator supplies an RF signal outside the receive channel for determining receiver

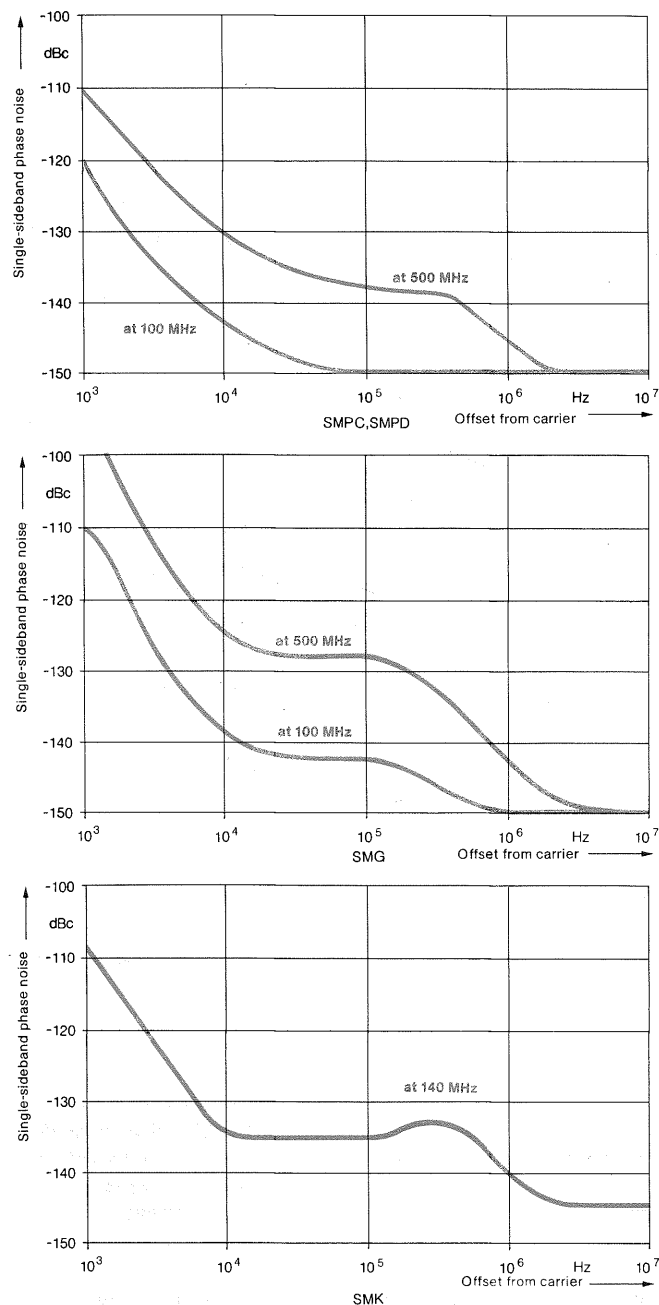

FIG 2 SSB phase noise with 1 Hz bandwidth as function of offset from carrier.

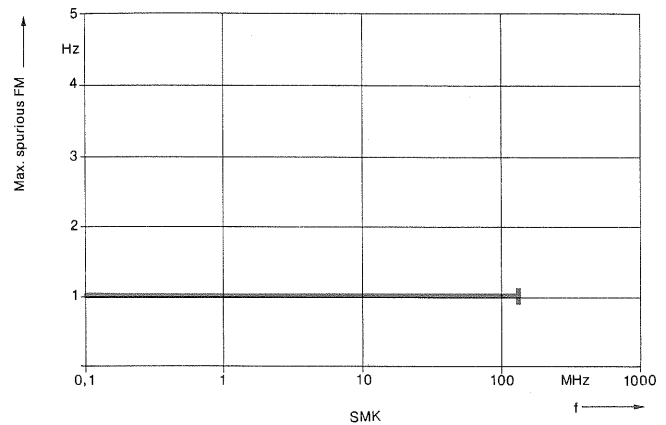
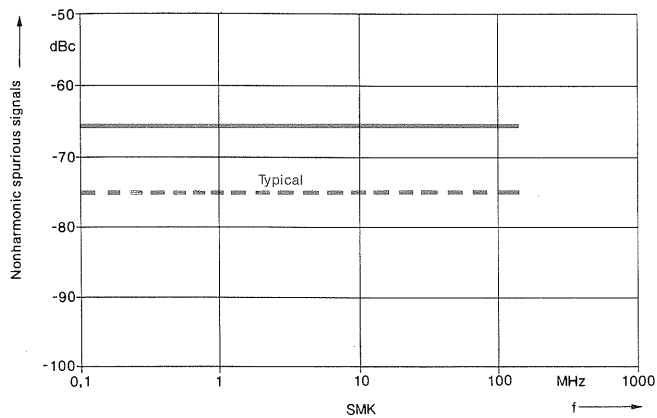
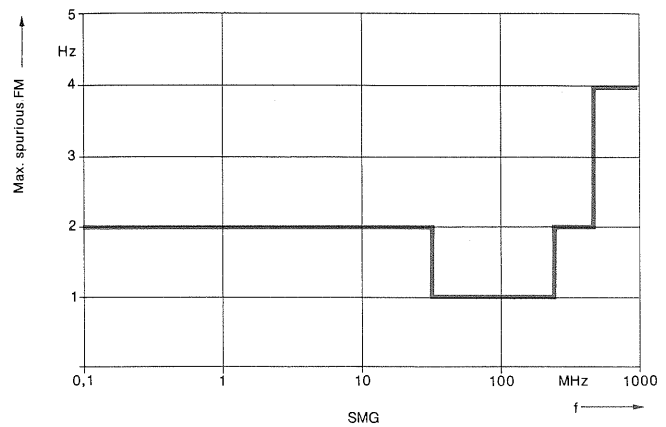
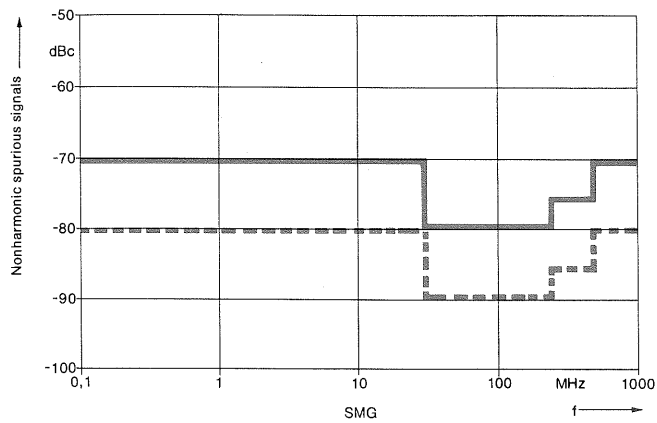
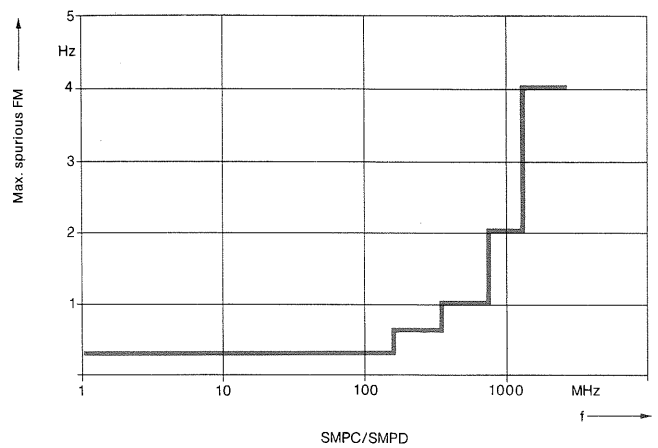
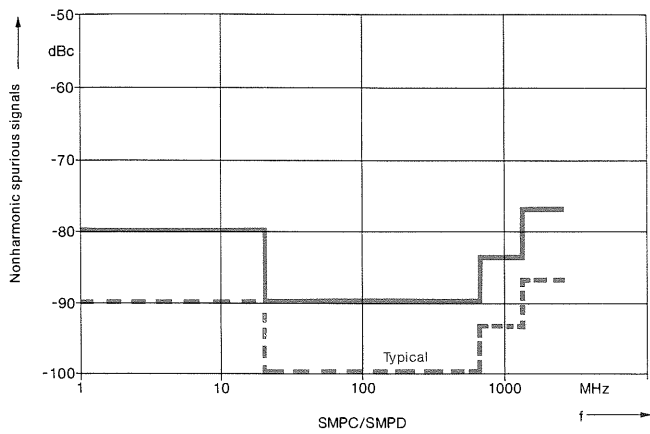

FIG 3 Maximum level of nonharmonic spurious signals as function of frequency.

FIG 4 Maximum spurious FM (300 Hz to 3 kHz, CCITT weighting) as function of frequency.

Low broadband noise of the signal source is essential for **blocking measurements** on mobile-radio receivers. Because of the minimum blocking level of 90 dB μ V specified by CEPT, only those signal generators can be used for measurements whose broadband noise is significantly below -140 dBc. The value is -145 dBc for SMPC and SMPD at carrier frequencies up to 21.25 MHz, and a mere -150 dBc for carrier frequencies from 21.25 to 1360 MHz.

Another critical measurement which can be carried out with SMPD is that of determining the **rejection of spurious responses** of mobile-radio sets up to above 2 GHz. To ensure that the minimum

value of 70 dB specified by CEPT can be measured, no interfering signals above -90 dBc originating from the test generator must enter the receive channel. The nonharmonic spurious signals of SMPD remain below -90 dBc in the frequency range from 21.25 to 680 MHz in which most popular radiotelephony bands are found.

Particularly low SSB phase noise of the test signal is also necessary for **desensitization measurements** on shortwave SSB receivers. An interfering-signal setting of 80 dB above the wanted signal is required at an offset of 30 kHz. Only a signal source can be used whose SSB phase noise is not above -140 dBc at an offset of

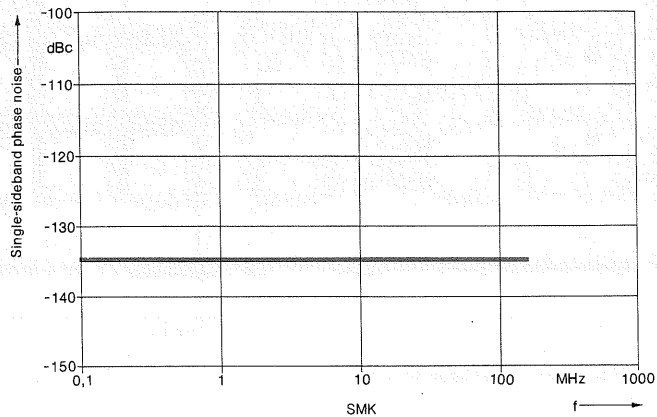
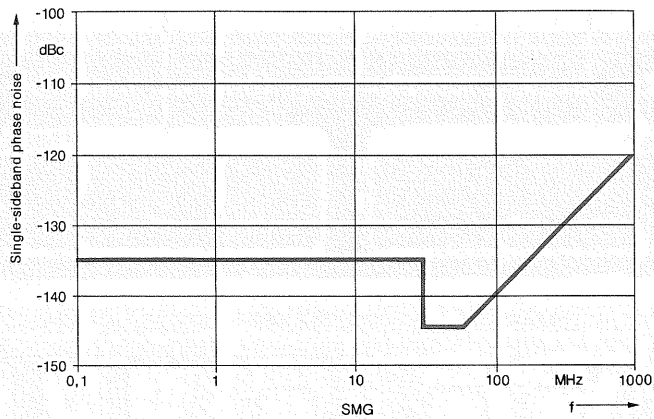
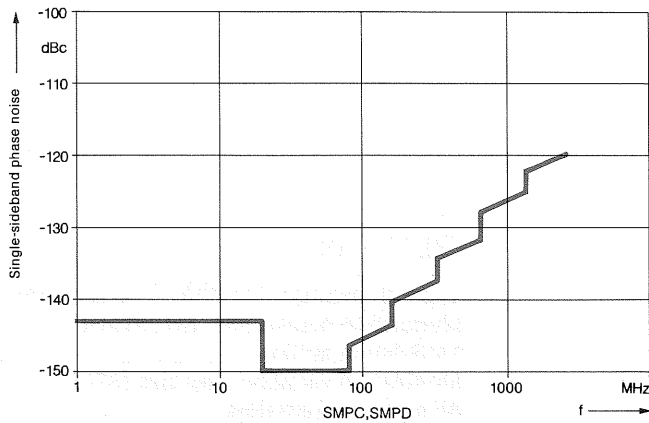

FIG 5 Single-sideband phase noise with 1 Hz bandwidth as function of frequency at 20 kHz offset from carrier.

30 kHz from the carrier to enable measurement **without influence** by the sideband noise of the interfering signal. SMPC and SMPD exceed this limit with -145 dBc in the entire shortwave range with an adequate margin.

Intermodulation measurements according to CEPT are particularly worth mentioning. The values measured are too good if the interfering-signal sources tuned to the next and next but one channels have poor noise characteristics. The sideband noise of

the interfering signal at the channel spacing must be less than -130 dBc for correct measurement of the required 70 dB intermodulation ratio.

An example of the fact that high demands are placed on spectral purity even with single-signal measurements is the **measurement of the S/N ratio of SSB receivers**. The spurious FM of the test signal must be so small that the wanted signal remains within the stopband of a very narrowband notch filter. This requirement is satisfied by each of the four signal generators described.

Nonharmonic spurious signals, produced by the AC line or microphone, may occur in the immediate vicinity of the carrier. These spurious signals are suppressed particularly well by Signal Generators SMG and SMK. The spurious signals remain below -60 dBc with SMG and below -75 dBc with SMK (FIGS 6 and 7).

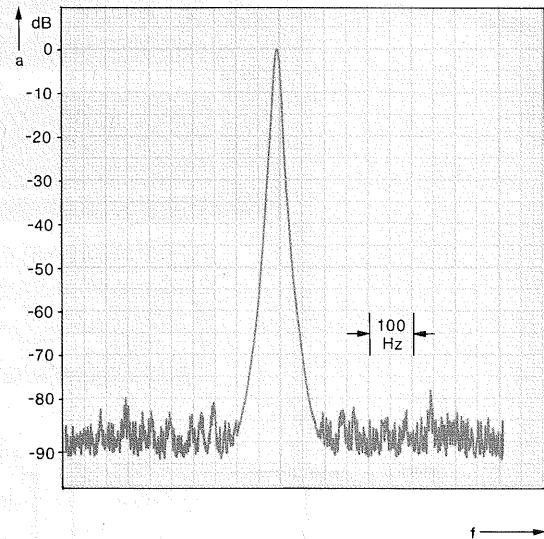

FIG 6 Spectral purity of SMK close to carrier (100 MHz).

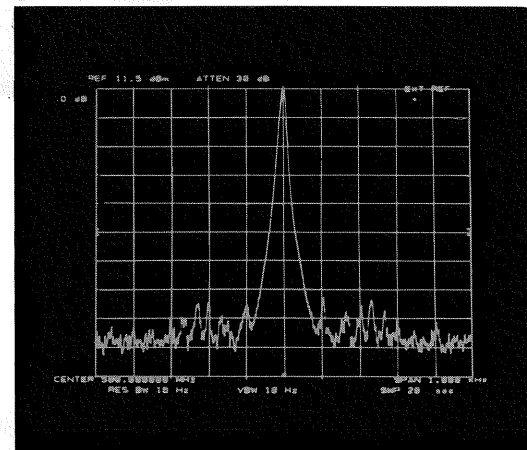

FIG 7 Spectral purity of SMG close to carrier.

SMG, SMPC and SMK are **free of subharmonic spurious signals**. The top octave is generated in SMPD by frequency doubling. The subharmonic spurious signals produced in the process are attenuated to less than -40 dBc by thinfilm bandpass filters (FIG 8).

SIGNAL GENERATOR SMG

Display of:

- RF output frequency, 10-digit
- RF variation step size (STEP)
- RF sweep parameters
- RF offset
- Storage sequence
- Status codes (special functions)
- IEEE/IEC-bus address
- External reference

Display of:

- Type of modulation (AM, FM, ϕ M, pulse)
- Modulation source (int., ext., AC/DC)
- Modulation setting
- Modulation variation step size (STEP)
- AF sweep parameters
- Status codes of input and hardware errors
- Ext. LOW/HIGH with external modulation

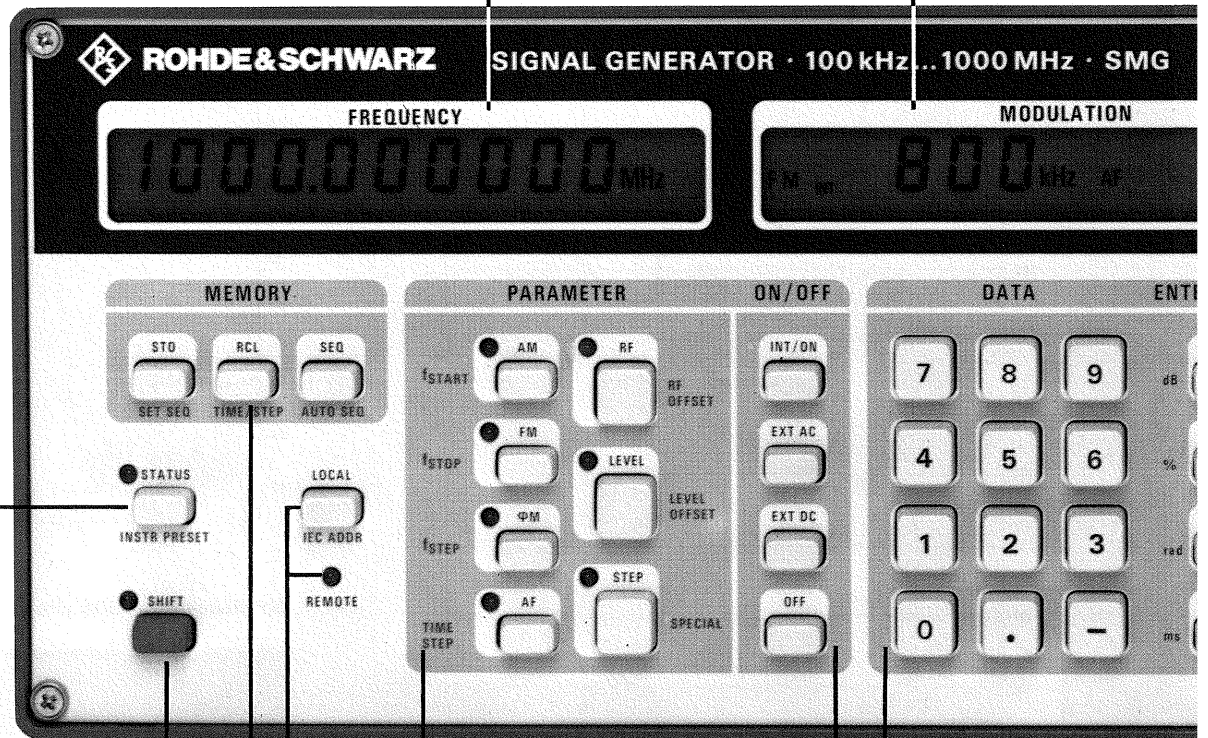

Instrument preset and display of status codes

Definition of shift parameters and functions

Keys for storing and calling instrument settings, for defining sequence and for manual or automatic calling of sequence

Parameter keypad:

Setting of parameters to which entered values and variation refer

Local/remote switchover, input and display of IEEE/IEC-bus address

Input keypad for data and units

Definition of modulation source, switch-on/off of set parameters

FRONT-PANEL DETAILS

Display of:

- RF and AF levels
- Level variation step size (STEP)
- Level offset
- Range of interruption-free level variation
- External overload
- Address of called instrument setting (sequence)
- Internal measured values (instrument test)

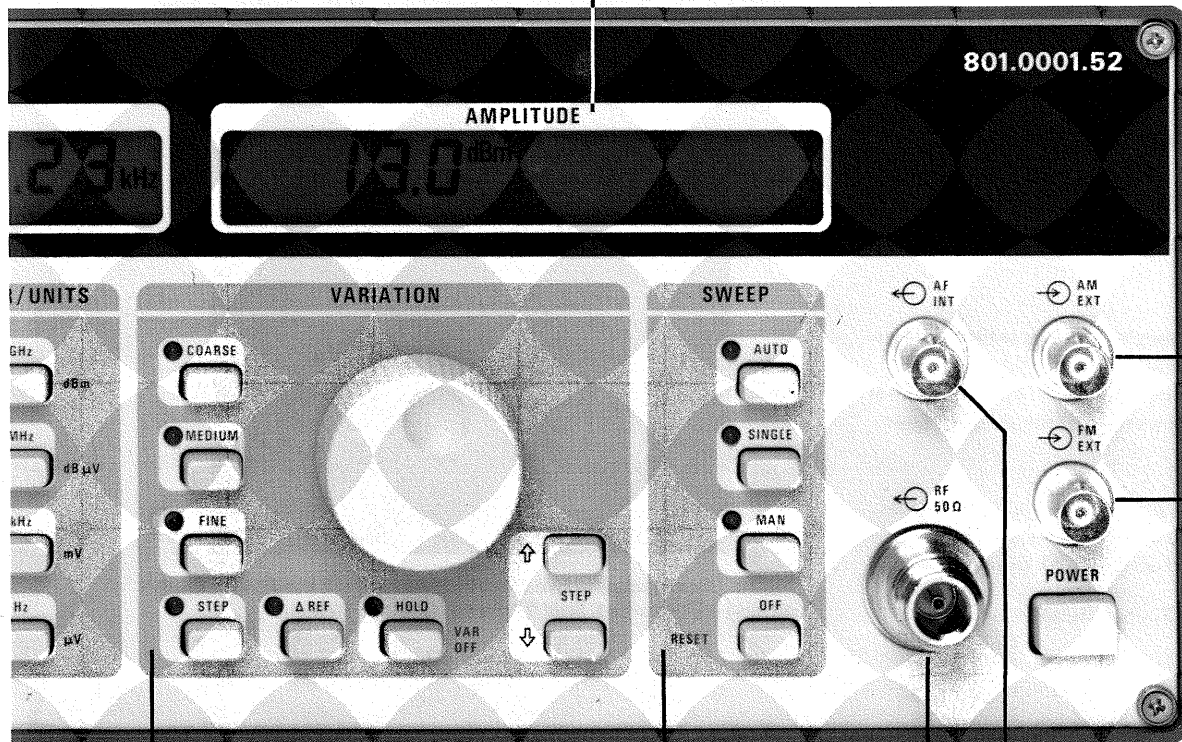

Keypad for parameter variation using spinwheel or STEP keys, three fixed and one freely selectable step size, Δ REF function to display frequency offset

Mode selection, switch-on/off of RF and AF sweep

Output of internal AF signal, level can also be adjusted using SMG-B2 option

Modulation inputs for external AM, FM, φM and pulse modulation with level check

RF output:

-137 to 13 dBm (16 dBm overrange), protected up to 50 W

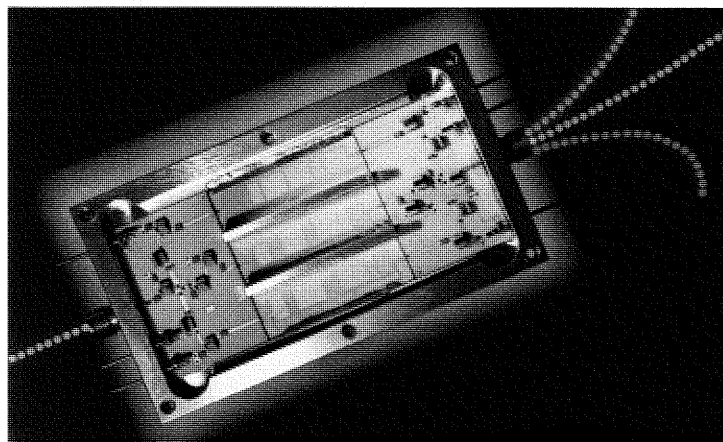

FIG 8 Thinfilm bandpass filters in frequency doubler of SMPD ensure optimal rejection of subharmonic spurious signals.

measurements can be carried out as a result of the low level errors. For levels above -127 dBm the total level errors are:

- within ± 1.5 dB for SMG and SMK
- within ± 1.5 dB up to 1000 MHz for SMPC and SMPD
- within ± 2.5 dB up to 2720 MHz for SMPD

With each level setting the mechanical attenuator set can be fixed and the level varied without interruption for squelch-hysteresis tests or for measurements on overload-sensitive amplifiers and receivers with automatic level control. This interruption-free level setting is possible over a range of 10 dB with SMPC and SMPD, and even above 20 dB with SMK and SMG. The attenuator set integrated in the instruments was devised for continuous use in automatic test systems and its precision is maintained even after 10 million operations.

SMK and SMG are particularly suitable for intermodulation tests at high levels; in both cases it is possible to fix the electronic level control. The internal intermodulation products then remain at

Output level

The four signal generators have wide output-level ranges of:

- SMG -137 to +13 dBm (overrange up to +16 dBm)
- SMK -138.9 to +19 dBm
- SMPC -143 to +13 dBm
- SMPD -143 to +13 dBm

with resolution of 0.1 dB. The accuracy of the level setting is determined by the precise mechanical attenuator set - typical accuracy 0.03 dB - and the low frequency response of the level control adjustable in 0.1-dB steps. FIG 9 shows the test record of an attenuator set.

Flat frequency response of the output level is essential for broadband measurements. Variations are below 1 dB for SMG and SMK, below 2 dB for SMPC and below 2.5 dB for SMPD. Exact sensitivity

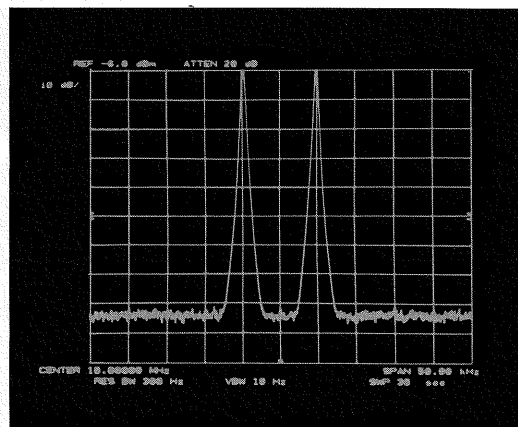

FIG 10 Combination of two SMKs by resistive 6-dB coupler. Frequency 10 MHz ± 5 kHz, signal level 0 dBm on generator output.

-80 dBc when combining two instruments via a resistive 6-dB coupler up to generator levels of 0 dBm (FIG 10).

Overvoltage protection is fitted as standard in all instruments to protect the output in transceiver measurements. SMK and SMPC are protected against RF power up to 30 W, SMG and SMPD up to 50 W.

Modulation

Each of the instruments offers high-grade, broadband AM, FM and (except SMK) ϕ M. Each signal generator enables two-tone modulation with internal and external signal sources. Two-tone modulation is required for example to simultaneously generate wanted and pilot-tone modulation (ringing tone, monitoring tone with cellular radio, controlled squelch, channel guard).

AC and DC coupling are possible for external AM and FM. In the case of AM, DC coupling is used for level control and level keying (pulse modulation), the dynamic range being 40 to 50 dB.

#Dämpfungstest +13...-125dBm#

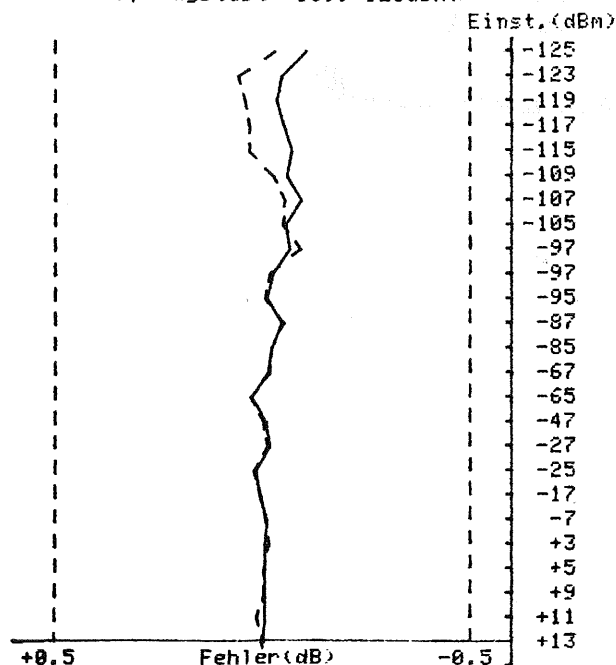

FIG 9 Test record for attenuator set.

Examples of application include tests on automatic gain controls or measurement of squelch attack times.

In the FM DC mode the signal generator can be used as a VCO for analog sweep or as a phase-synchronized signal source in a PLL. An analog sweep is used to display frequency response, of filters or frequency demodulators for example. The amplitude of the control signal remains constant with an externally controlled sweep and the sweep width is defined as a normal deviation input via the keypad.

DC coupling can also be selected for digital frequency modulation such as **FSK** (frequency shift keying). This has the advantage that no tilts occur, that any nonsymmetrical curve shapes can be used for modulation and any extreme bit sequences (eg more H than L states) have no influence on the carrier frequency.

The frequency offset which naturally occurs in the FM DC mode is kept to a minimum in the instruments by digital storage of the control voltage. SMK contains a special frequency control loop which keeps this frequency error particularly low. It also contains a frequency counter which displays the actual output frequency in the FM DC mode.

AF synthesizer

An AF synthesizer is used as an internal modulation source in SMPC, SMPD and SMG (**SMG-B2 option**). It provides crystal-accurate, low-distortion sinewave signals from 10 Hz to 100 kHz with resolution of 1 Hz below 10 kHz and 10 Hz above 10 kHz (distortion 0.05%). The AF synthesizer can also generate **selective-calling sequences of all standards** by means of **phase-continuous frequency changeover** with short switching times (< 10 ms).

Modulation characteristics SMG

The AM frequency range is 10 Hz (DC) to 50 kHz. The modulation frequency-response flatness is below 0.4 dB up to 10 kHz and below 1 dB up to 50 kHz. The low phase shift at 30 Hz (AM DC) and the large AM bandwidth with flat frequency response up to above 11 kHz mean that SMG is particularly suitable for **tests on VOR/ILS navigation receivers***; the VOR azimuth error remains **below 0.1°**.

FM is possible with bandwidths from 10 Hz to 100 kHz (AC) and DC up to 100 kHz. Thus **stereo modulation with channel separation of 50 dB** is possible. The distortion is less than 0.1% at 1 kHz and with half the maximum deviation. SMG contains an internal modulation source as standard with eight fixed frequencies from 40 Hz to 15 kHz; this can be replaced by the SMG-B2 option (AF synthesizer 10 Hz to 100 kHz). The AF synthesizer serves as an internal modulation source and audio-signal source for external applications; the amplitude of the output signal can be adjusted in 1-mV steps from 1 mV to V.

* VOR: VHF Omnidirectional Range. Radio position-finding method (rotating radio beacon) by comparison of the phase of two 30-Hz signals.

ILS: Instrument Landing System with azimuth and glide-path guidance by generating the section of two beams with an amplitude-modulated carrier frequency of 90 Hz and 150 Hz.

Fitted with the AF synthesizer, SMG can be used for an AF sweep with **freely selectable start/stop frequency, step size and time** with phase-continuous frequency changeover. This operating mode, which is also possible with two-tone modulation together with an external signal source, is used to record audio-frequency responses. If SMG is equipped with the SMG-B2 option, it is possible to control pulse modulation and digital frequency modulation using TTL signals.

Modulation characteristics SMK

SMK is designed for AM and FM. Two-tone modulation is possible with one internal and one external modulation source or with two external sources. Two external modulation inputs are available. A **pilot-tone input** is also available for FM; the applied pilot tone is not influenced by the deviation setting.

The maximum FM deviation of 500 kHz can be set across the complete carrier-frequency range. The modulation bandwidths with external modulation are 20 Hz (DC) up to 20 kHz with AM and 20 Hz (DC) up to 200 kHz with FM. The FM frequency response is flat within 0.2 dB at frequencies up to 100 kHz and within 1 dB up to 200 kHz. The **Crosstalk attenuation of 60 dB** means that stereo crosstalk can be neglected.

SMK is equipped with an **internal sweep generator** (3, 30 and 100 Hz) which enables analog narrowband sweeping of tuning circuits, IF amplifiers, FM demodulators and steep crystal and ceramic filters. The sweep width can be set using the keypad up to 500 kHz.

A **40-MHz test input** is present on SMK for **intermodulation measurements on SSB receivers**. Two 40-MHz signals applied to this input are converted to the set output frequency. The 3rd-order intermodulation products resulting from SMK – even within the J3E sideband – are suppressed by at least 60 dB.

Modulation characteristics SMPC and SMPD

Both instruments enable **simultaneous and independent setting of AM, FM and ΦM** ; SMPD is also prepared for **pulse modulation** (option). The high modulation quality (AM distortion < 1% up to 1360 MHz, FM distortion < 0.1%, stereo crosstalk attenuation 56 dB) also enables measurements on AM and FM hi-fi broadcast receivers. The modulation bandwidths are 10 Hz (DC) up to 50 kHz in AM and 10 Hz (DC) up to 125 kHz in FM. SMPD provides signals for **extensive tests on radar receivers** when equipped with **pulse-modulator option SMPD-B1**. Pulse modulation (FIG 11) is possible in the carrier-frequency range from 500 MHz to 2.72 GHz. Rise and fall times of 10 ns apply to the envelope curve of the pulsed carrier. The maximum repetition frequency is 1 MHz, the carrier on/off ratio at least 80 dB. The pulsed carrier can be amplitude-, frequency- or phase-modulated **at the same time**.

Sweep

A useful and powerful digital sweep can be used for many measuring problems with SMG, SMPC and SMPD. The sweep parameters, start/stop frequency, step size and step time are freely selectable. The sweep may be periodic, one-shot or manual using spinwheel tuning. The synthesizer accuracy is still retained in sweep mode. In addition to the linear frequency sweep, a logarithmic frequency sweep can be set where broadband frequency responses can be recorded on a logarithmic frequency axis. In addition to recording frequency responses, the sweep can also be used for receiver tests, for example measurement of spurious responses. In computer-controlled applications the current sweep frequency can be called by the controller in the talker mode.

Besides the RF sweep, SMG also enables a digital AF sweep with freely selectable start/stop frequencies, step size and step time.

Operation

The four instruments can be set using the keypad, a spinwheel (not SMK) and the standard IEEE/IEC-bus remote-control interface. Variation is carried out in SMK using decadic variation keys. All instruments enable frequency variation in any steps, also programmable (channel pattern). SMG also permits level and modulation parameters to be varied in steps as required. The varied parameter can be displayed as a Δ value (difference from the selected reference value), which is useful for bandwidth determinations. Parameters such as level which can be switched on and off or functions such as modulation or sweep can be initialized at stored values using one key. As many as 40 instrument settings can be stored in a nonvolatile memory.

FIG 11 Signal Generator SMPD with display of pulsed carrier.



The stored SMG instrument settings can be set individually using the RCL key or in a fixed sequence using the SEQ key. An automatic sequence with adjustable dwell time is possible in addition.

Frequency and level of the SMG output signal can be provided with any offset. This facility is used to compensate for cable atten-

uations or to enter the receive frequency directly in local-oscillator applications.

Manual operation and the remote-control codes are described in detail for all four instruments on an extractable card.

Franz Lüttich

CONDENSED DATA SIGNAL GENERATOR SMPD

Frequency range	5 kHz to 2.72 GHz
Resolution	0.1 Hz up to 1 GHz, 1 Hz above
Output level	-143 to 13 dBm (0.016 μ V to 1 V into 50 Ω)
SSB phase noise with 1 Hz bandwidth and 20 kHz offset	
at 100 MHz	-147 dBc
at 500 MHz	-134 dBc
at 2.72 GHz	-120 dBc
Nonharmonic spurious signals	
< 21.25 MHz	< -80 dBc
21.25 to 680 MHz	< -90 dBc
680 to 1360 MHz	< -84 dBc
1360 to 2720 MHz	< -78 dBc
Subharmonic spurious signals (only for $f_c > 1.36$ GHz)	< -40 dBc
Frequency modulation	0 to 125 kHz, deviation up to 3200 kHz
Phase modulation	10 Hz to 8 kHz, deviation up to 400 rad
Amplitude modulation	0 to 50 kHz, up to 99% AM
Pulse-modulation option SMPD-B1	external, $f_c > 500$ MHz
Rise/fall time	10 ns
Carrier on/off ratio	> 80 dB
Remote control	IEC 625-1, IEEE 488
Frequency settling time	< 18 ms < 7 ms for 34 stored settings
Ordering number	376.8011.52

CONDENSED DATA SIGNAL GENERATOR SMG

Frequency range	100 kHz to 1000 MHz
Resolution	1 Hz
Output level	-137 to 13 dBm
Overrange	can be set up to 16 dBm
SSB phase noise with 1 Hz bandwidth and 20 kHz offset	
at 100 MHz	-140 dBc
at 1000 MHz	-120 dBc
Nonharmonic spurious signals	
< 31.25 MHz	< -70 dBc
31.25 to 250 MHz	< -80 dBc
250 to 500 MHz	< -76 dBc
500 to 1000 MHz	< -70 dBc
Frequency modulation, AC and DC	0 to 100 kHz, deviation up to 800 kHz
Phase modulation	10 Hz to 10 kHz, deviation up 80 rad
Amplitude modulation, AC and DC	0 to 50 kHz, up to 99% AM
Modulation generator, standard	0.04/0.15/0.3/0.4/1/3/6/15 kHz \pm 3%
Modulation generator, option	10 Hz to 100 kHz, crystal-accurate
Remote control	IEC 625-1, IEEE 488
Frequency settling time	15 ms
Ordering number	801.0001.52

CONDENSED DATA SIGNAL GENERATOR SMPC

Frequency range	0.05 to 1360 MHz
Resolution	0.1 Hz up to 1 GHz, 1 Hz above
Output level	-143 to 13 dBm (0.016 μ V to 1 V into 50 Ω)
Remote control	IEC 625 bus
SSB phase noise with 1 Hz bandwidth and 20 kHz offset	-134 dBc at 500 MHz -147 dBc at 100 MHz
Nonharmonic spurious signals	< -90 dBc from 21.25 to 680 MHz < -84 dBc from 680 to 1360 MHz < -80 dBc up to 21.25 MHz
Modulation generator	10 Hz to 100 kHz
Harmonics and nonharmonics	-65 dBc
Frequency modulation	0 to 100 kHz, deviation up to 1600 kHz
Distortion at half maximum deviation	< 0.1%
Stereo channel separation	56 dB for 100 Hz to 10 kHz
Unweighted signal/noise ratio	> 76 dB (stereo) at 100 MHz/ 40 kHz/50 μ s
Amplitude modulation	0 to 50 kHz, 0.1 to 99% AM
Distortion	< 1% up to 20 kHz at 80% AM
Phase modulation	10 Hz to 8 kHz, deviation up to 200 rad
Ordering number	300.1000.52

CONDENSED DATA SIGNAL GENERATOR SMK

Frequency range	10 Hz to 140 MHz
Resolution	1 Hz
Output level	-138.9 to 19 dBm (0.025 μ V to 2 V into 50 Ω)
SSB phase noise with 1 Hz bandwidth and 20 kHz offset	< -130 dBc (typ. -135 dBc)
Nonharmonic spurious signals	< -65 dBc (typ. < -75 dBc)
Modulation generator	150, 400 Hz, 1, 3, 15 kHz sinewave 3, 30, 100 Hz triangular wave
Frequency modulation	0 to 100 kHz, deviation up to 500 kHz
Distortion (deviation = 100 kHz, $f_m = 1$ kHz)	< 0.05% (typ. 0.02%)
Stereo channel separation	> 56 dB
Unweighted signal/noise ratio (deviation = 40 kHz, 50 μ s)	> 76 dB
Internal sweep	deviation up to 500 kHz (counter-accurate display of centre frequency)
Amplitude modulation	0 to 20 kHz, up to 100% AM
Distortion (80% AM, $f_m = 1$ kHz)	< 0.5% (typ. 0.2%) up to 2 MHz < 1% (typ. 0.4%) above 2 MHz
Remote control	IEC 625-1, IEEE 488
Ordering number	348.0010.02

Process controllers of the 16-bit computer family PCA from Rohde & Schwarz can handle a wide range of tasks in all fields of computer application. Performance, design and many options for tailored problem-solving distinguish them from run-of-the-mill personal computers.

The PCA computer concept in transceiver testing

FIG 1 More than just a personal computer: Process Controller PCA 5 with built-in 9-inch monitor.

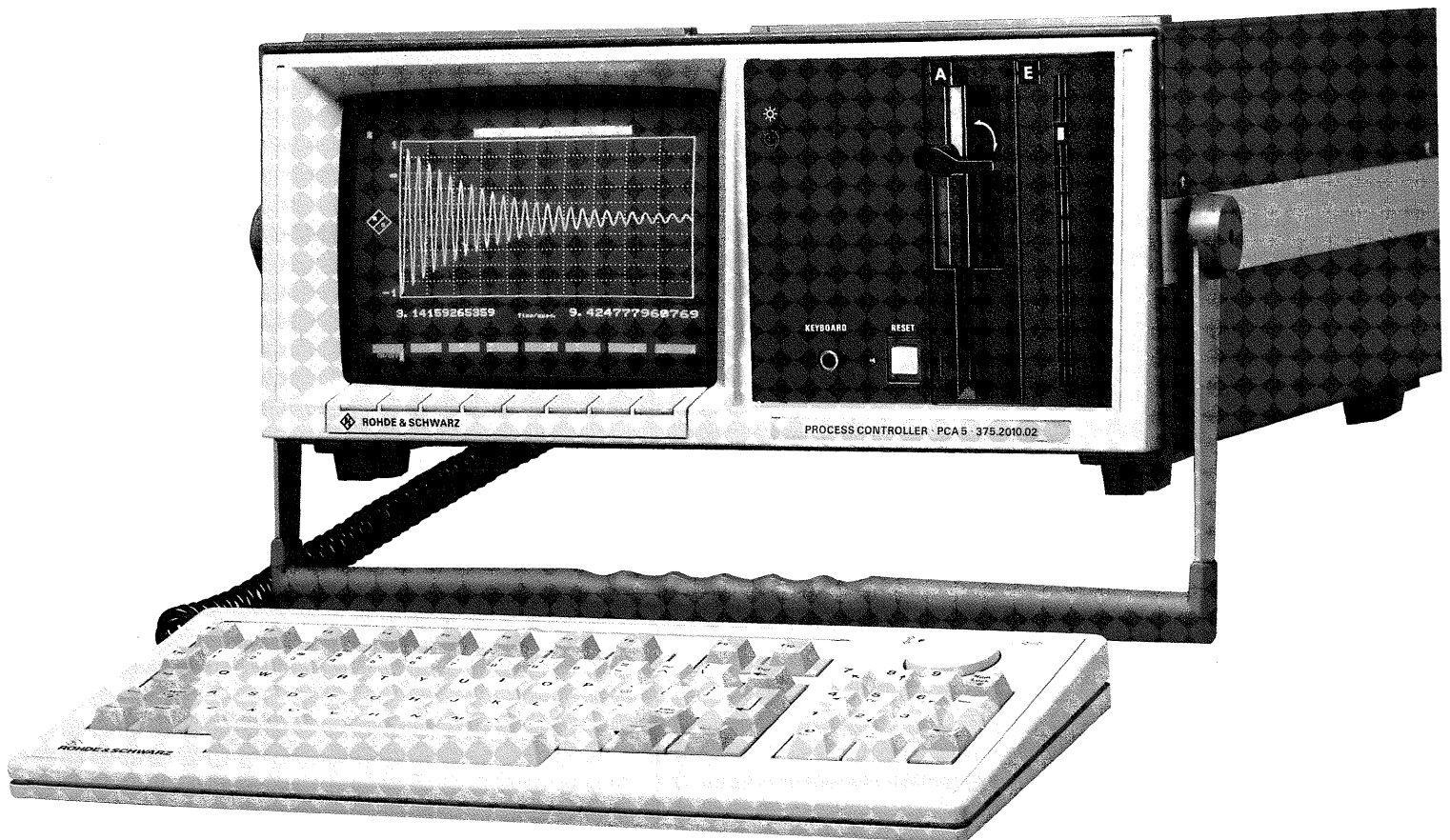

Complex test runs and stringently defined test procedures in mobile radiotelephone testing are noteworthy examples of the use of powerful test systems*. The standard IEC-625 (IEEE 488) bus as a digital communication interface between instruments and control unit is an important aid in automating measuring tasks in development, production and final goods inspection.

Rohde & Schwarz has underscored the capabilities of its transceiver testers with the new PCA processor concept (FIG 1). These PCA controllers were developed in close cooperation with measurement-engineering specialists and therefore offer the **optimal solution** to numerous measurement problems in many situations. The **standard MS-DOS operating system** opens up to the user the

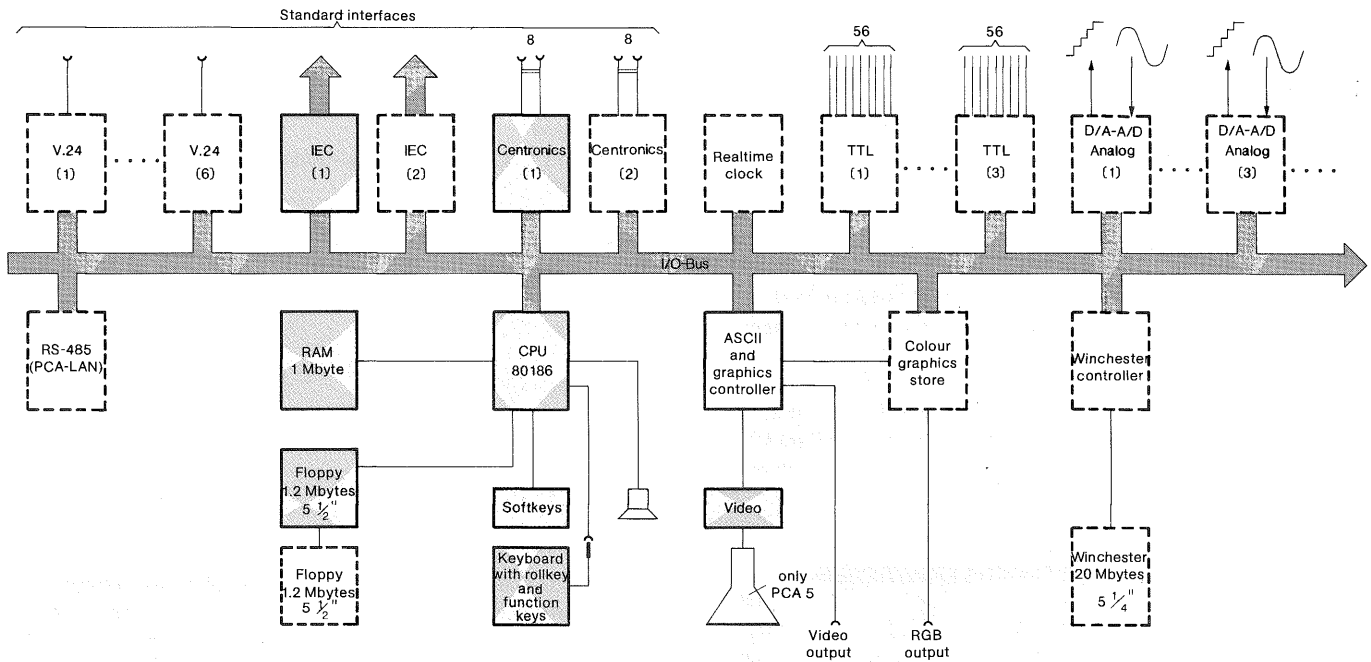

FIG 2 Processor architecture of PCA controllers; options shown in broken lines.

FIG 3 PCA software concept.

The high built-in intelligence of Rohde & Schwarz radio testers permits future-oriented, decentralized evaluation of measurement results. In other words the **instrument itself handles** the raw measurement data (voltage, frequency, resistance, etc) providing comprehensible data and reducing them to relevant essential information. The system control unit only receives the **condensed data record**, the measured-data-ready signal being expediently interrupt-controlled. Although the work load of control unit and IEC/IEEE bus is reduced substantially as a result, demands placed on the process controller are increased considerably by the decentralized intelligence. This applies in particular to **interrupt handling, multicontroller operation and the required IEC/IEEE-bus command set**.

After statistical evaluation of measurement data the results of the quality control of transceivers should be fed back into development and production so that maxima of the frequency distribution of faulty components can be discovered and eliminated as soon as they occur. In this way the proper trade-off can be achieved between equipment quality and competitive price levels.

Up-to-date process controllers should not only be able to control IEC/IEEE-bus test systems but also have the means of **including product data in a database system** and thus enable the drawing up of easy-to-follow production profiles and quality statistics.

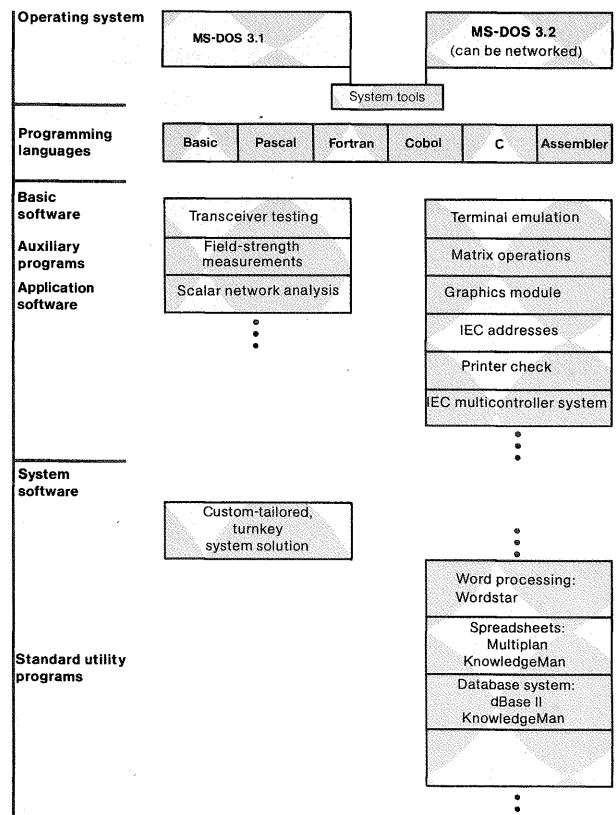

* Jonas, H.-J.: Is automatic testing worthwhile; Modern 2-way radio test sets with integrated microprocessor control. R & S 1981, 1 GV-0004-e.

whole range of **MS-DOS utility programs** such as word processing, databases, spread-sheet calculation. FIG 2 illustrates the hardware architecture of Process Controllers PCA 2 and PCA 5 and FIG 3 the PCA software concept.

Even in their basic configuration the PCA processors fulfil the most stringent requirements. The **modular hardware and software concept** keeps initial investment low but offers the possibility of customizing the controllers through a variety of options (plug-in cards). All tasks required in the applications

- general computation
- automatic measurement and control
- computer and data networking
- workstation computers

can therefore be solved optimally.

PCA controllers are accommodated in an **RF-shielded 19-inch housing**. The PCA 5 has an integrated, 9-inch monochrome monitor and is chiefly used in mobile, compact test systems. The PCA 2, on the other hand, with its separate, 14-inch colour monitor is intended as a workstation computer for software development or in technical/business applications. For the latter the standard MS-DOS operating system proves to be of great value since it offers the user access to a wide software market (FIG 3).

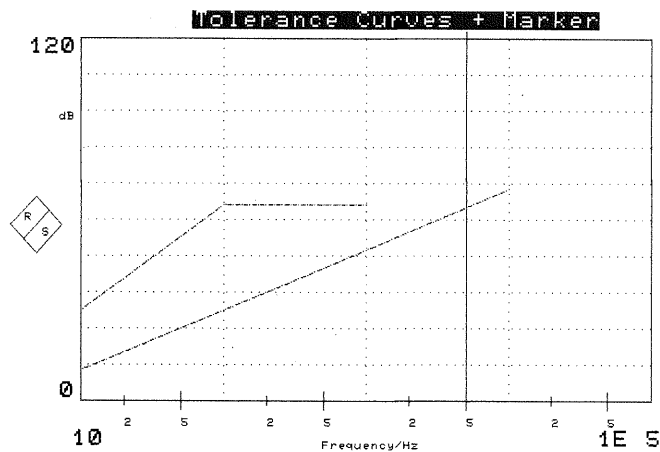
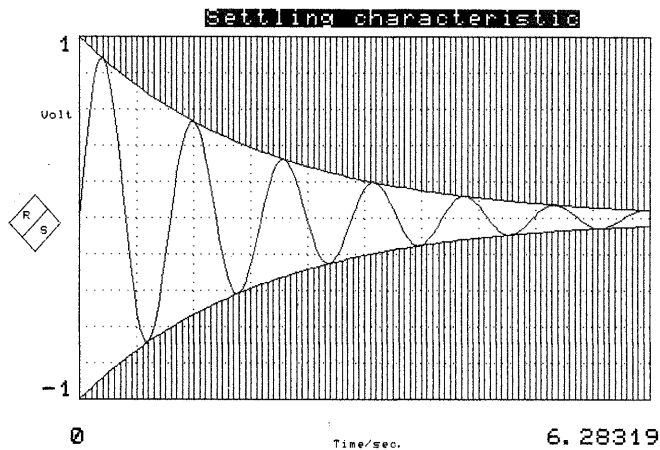

FIG 4 Measurement data can be output in variety of representations with aid of graphics software module GPHMOD.

In **transceiver testing** the use of the PCA 5 is of interest not only because of its powerful IEC/IEEE-bus interfaces and convenient IEC/IEEE-bus command set but also on account of the **well-proven basic software** for transceiver testing and numerous **application software packages** that are partly supplied as standard.

PCA controllers can handle two completely independent IEC/IEEE-bus interfaces:

Interrupt handling with SRQ

* ON SRQ (a) GOSUB
a = 1,2 for IEC 1/IEC 2

Parallel poll

* IEC (a) PCON, <sense>; <line> (configuration)
IEC (a) PPL, PP%

Serial poll

* IEC (a) SPL, SP%

are possible, as well as:

IEC multicontroller mode

- * IEC (a) RLC (release control)
- * IEC (a) TCT (take control)
- * IEC (a) WCT (wait for TCT)
- * IEC (a) RQS <status> (SRQ with <status>)

Application software for multicontroller operation, bus-address search program, etc is contained on the **supplied system floppy** as well as a **graphics module** for linear and logarithmic representation of measurement data (FIG 4). Apart from the construction of diagrams the graphics module performs **conversion of measurement data** to graphics coordinates and provides their display with eight selectable special functions, enabling the user to fully **concentrate on the measurement task**.

R&S basic software modules for transceiver testing have proved their exceptional value, incorporating as they do all the routines required for transmitter and receiver measurements. Example: receiver sensitivity at 20 dB SINAD (routine 67):

```
100 Y = 20 : R = 67 : GOSUB 9000 : PRINT Y; "µV"
```

required	selector	branch to	output
SINAD	for basic	basic soft-	sensitivity
value	software	ware	in µV
	routine		

The simple handling of the test modules affords **fast writing** of application-specific user software. This software is illustrated by a generally configurable test program for automatic test systems, written for the PCA 5 in an R&S test department, where the program is also used. A PCA 5 graphics hardcopy demonstrates the modular structure of the test program (FIG 5).

The manager PP-PCA 5 is the RAM-resident core of the program and contains an editor for system-specific test-routine files. A test protocol is also drawn up containing information on the execution of test modules as well as test specifications. Test routines can of course be edited according to specific test procedures and be saved on mass storage as files (FIG 6) for callup at any time.

FIG 5 Modular test program for automatic systems.

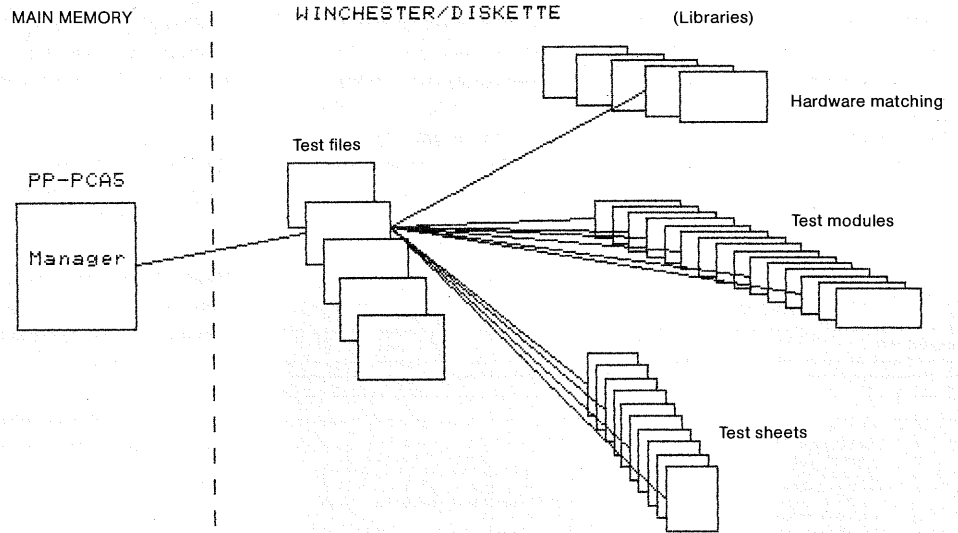

FIG 6 Extract from test report for transmitter measurement.

PRUEFPROTOKOLL		
GERAET/ANLAGE: EQUIPMENT/SYSTEM:	VHF-TRANSCEIVER XU 452 F	
BEZOGEN AUF PRUEFUNTERLAGE: REFERING TO TEST DOCUMENTATION:	623.1309	AEI/AUSG. A MODIFICATION:
SACHNUMMER DES PRUEFLINGS: PART NO. OF TEST ITEM:	623.1309.12	
FERTIGUNGSNUMMER: SERIAL NO.:	555555.555	
VERSORGUNGSNUMMER: SUPPLY NO.:		
AUFTRAGSNUMMER DES KUNDEN: CUSTOMER'S REFERENCE NO.:		
AUFTRAGSNUMMER DES HERSTELLERS: FA MANUFACTURER'S REFERENCE NO.:		
MESS + PROTOKOLLPROGRAMM NAME: TEST + REPORT PROGRAM NAME:	62313012.PRG	AEI. 09-08-85
PRUEFFELD: TESTDEPARTMENT:	QUOTESICHERUNG: QUALITY ASSURANCE:	KUNDE: CUSTOMER:
DATUM: 09-08-85 DATE:.....	DATUM: DATE:.....	DATUM: DATE:.....
AEI: A	AEND.-DATUM: 09-08-85	GP-NR.: 623.1309.12 GP
ROHDE & SCHWARZ	REG.I.V. V	BLATT 1 VON: 9

PLFD	ART DER PRUEFUNG	TEMPERATUR	+25 GRAD C	
NR.	ABSCHNITT D. PRUEFUNTERLG.	SOLLWERT	ISTWERT	BESTGT.
10	101 VARIATION OF MODULATION 623.1309 T 5.17 at 146.000 MHz			
	narrow 600 ohms 0dBm+15dB	0.80..0.90	0.8	
	narrow 600 ohms 0dBm-15dB	0.80..0.90	0.85	
	narrow 600 ohms 2.5mV+15dB	0.80..0.90	0.88	
	narrow 600 ohms 2.5mV-15dB	0.80..0.90	0.82	
11	111 MOD. FREQUENCY RESPONSE AM 623.1309 T 5.18 at 146.000 MHz			
	narrow 300 to 3400 Hz 600 ohms	<= 4 dB	4.59 dB	
	200 ohms	<= 4 dB	5.76 dB	
	broad 40 Hz to 8 kHz 2000 ohms	<= 4 dB	4.15 dB	
12	121 MOD. FREQUENCY RESPONSE FM 623.1309 T 5.19 at 146.000 MHz			
	narrow 300 to 3400 Hz	<= 4 dB	2.82 dB	
	at 162.975 MHz	<= 4 dB	2.56 dB	
13	131 MOD. DISTORTION AM 623.1309 T 5.20 at 146.000 MHz			
	narrow 600 ohms 0dBm	<= 5 %	3.02 %	
	narrow 600 ohms 0dBm +15dB	<= 5 %	1.7 %	
	narrow 200 ohms 2.5mV	<= 5 %	1.73 %	
	narrow 200 ohms 2.5mV+15dB	<= 5 %	0.79 %	
	broad 2000 ohms 4.0 Vss	<= 5 %	1.61 %	
14	141 MOD. DISTORTION FM 623.1309 T 5.21 at 146.000 MHz			
	narrow 600 ohms 0 dBm	<= 5 %	2.3 %	
	narrow 200 ohms 2.5 mV	<= 5 %	0.79 %	
15	151 PERMISSIBLE MISMATCH 623.1309 T 5.22 at 146.000 MHz			
		0.K.		
R & S	AEI. A	F.NR. 555555.555	GP-NR. 623.1309.12 GP	BL. 4

Furthermore, the test-routine file contains test modules which are identical to the modules of the basic software included in the transceiver test table. The only difference is that the manager loads the required test modules in a **RAM overlay area** for executing the test protocol so that only the current test module is in the working memory. The overlay technique is well supported by the **Basic command set** of the PCA controller and permits, on the one hand, optimal utilization of memory capacity and, on the other, affords **simple program maintenance and extension** through the modularity of the software.

Zeit: 08:02	Datum: 09-08-85	Temperatur: 25 Grad	Selbsttest: gut
PRUEFLING: VHF-TRANSCEIVER		XU 452 F	
Ident-Nummer: 623.1309.12		Prog.: 62313012.PRG	
		Aend.-Dat.: 08-08-85	
1	MECHANICAL INSPECTION	16	HARMONIC EMISSIONS
2	OPERATIONAL CHECK MEMORY	17	NON-HARMONIC EMISSIONS
3	FREQUENCY AND DISPLAY	18	SIGNAL TO NOISE RATIO AM
4	AM-FM CONTROL	19	FREQUENCY RANGE I AM
5	CARRIER POWER (AC SUPPLY)	20	FREQUENCY RANGE II AM
6	CARRIER POWER (DC SUPPLY)	21	SQUELCH
7	FREQUENCY ACCURACY	22	SENSITIVITY FM
8	MODULATION DEPTH WITH AM	23	SELECTIVITY
9	FREQUENCY DEVIATION W. FM	24	IMAGE FREQ. REJECTION
10	VARIATION OF MODULATION	25	LOCAL OSC. OUTPUT
11	MOD. FREQUENCY RESPONSE AM	26	IF REJECTION
12	MOD. FREQUENCY RESPONSE FM	27	CROSSMODULATION
13	MOD. DISTORTION AM	28	INTERMODULATION
14	MOD. DISTORTION FM	29	DESENSITIZATION
15	PERMISSIBLE MISMATCH	30	AGC ERROR

weiter mit >RET< zurueck mit -- Hilfe mit H

Zeit: 08:02	Datum: 09-08-85	Temperatur: 25 Grad	Selbsttest: gut
PRUEFLING: VHF-TRANSCEIVER		XU 452 F	
Ident-Nummer: 623.1309.12		Prog.: 62313012.PRG	
		Aend.-Dat.: 08-08-85	
31	OUTPUT LEVEL AM	39	FREQUENCY ACCURACY GUARD
32	FREQUENCY RESPONSE AM	40	IMAGE FREQ. REJECT. GUARD
33	DISTORTION AM	41	LOCAL OSC. OUTPUT GUARD
34	OUTPUT LEVEL FM	42	IF REJECTION GUARD
35	FREQUENCY RESPONSE FM	43	CROSSMODULATION GUARD
36	DISTORTION FM	44	SQUELCH GUARD
37	SENSITIVITY GUARD	45	AGC ERROR GUARD
38	SELECTIVITY GUARD	46	AF OUTPUT GUARD

weiter mit >RET< zurueck mit -- Hilfe mit H

FIG 7 Menu of transmitter modules installed by PP-PCA manager. Transmitter measurements found to be out of tolerance are printed bold.

The installation of a **virtual disk (RAM disk)** with negligible access time upgrades program linking (LOAD) and overlaying (CHAIN) to **professional programming**. Through the possibility of programming **batch processes and autostart batch files** under MS-DOS control, the boot-up state (eg installation of RAM disk, copying files from Winchester disk drive to RAM disk, loading PCA Basic and test programs, etc) can be performed for the user fully in the background.

FIG 7 shows a PCA 5 printout of the transmitter test modules. Results of measurements which, according to the test protocol, exceed rated tolerance values are printed bold. This output attribute is supported in the PCA by the **standard ANSI interface**.

The test report (FIG 6) reveals that all values of the AM modulation-frequency response (test module 11) are out of tolerance whereas the values for AM modulation distortion 1 are correct. After checkup of the transmitter concerned, only the measurements printed bold need (can) be repeated. This feature is brought about by the **complete documentation** of the test-routine files and of the protocol files on mass storage.

The modular hardware adaptations shown in FIG 5 are essentially IEC/IEEE driver software, which is supplied on the **PCA system diskette** by R&S for all complex measuring instruments.

If test results are to be stored in a particular format as a text file, they can also be processed directly by the **database system dBase II**. All the facilities of a **worldwide standard database system** are thus opened up to the user.

It is precisely this combination of a process controller with above-average capabilities and a workstation computer with wide software support that makes the R&S computer family PCA a welcome alternative in its field.

Franz Dosch

CONDENSED DATA PROCESS CONTROLLER PCA 5

CPU, clock	iAPX 186.8 MHz
RAM	1 Mbyte with parity bit
Floppy-disk drive	1.2 Mbytes per drive (MS-DOS)
Option Winchester drive	20 Mbytes (MS-DOS)
Graphics	640 x 480 points
ASCII characters	128 with 13 attributes
Interfaces	IEC 625-1 (IEEE 488), Centronics, composite video
Options	RS-232-C interface, 2nd IEC bus, realtime clock, TTL I/O port, analog I/O port, external floppy-disk drive
Operating system	MS-DOS 3.1
Languages	Basic and Pascal (with graphics and IEC bus), assembler; others on request
Ordering number	375.2010.04

Versatile Modulation Analyzer FAM combines the measuring capabilities of five instruments: modulation and spurious-modulation meter, frequency counter, distortion meter and psophometer. Microprocessor control of the instrument settings makes for simple measurement and interpretation of all kinds of RF signals, including stereo. Just as with all modern Rohde & Schwarz test instruments, the FAM can be integrated into automatic test assemblies via an IEC/IEEE bus.

Modulation analysis from 55 kHz to 1360 MHz with FAM

Advances in telecommunications and the associated increase in communications traffic necessitate tighter control of signal characteristics. Subsequently the requirements for quality and quantity of measurements increase, from which the corresponding demands on the test instrumentation can be derived. Modulation measuring instruments cannot be excluded; they must be fast, accurate and versatile.

The microprocessor-controlled, high-precision Modulation Analyzer FAM (FIG 1) from Rohde & Schwarz exceeds these requirements. In the frequency range from 55 kHz to 1360 MHz it can be used for measurements on practically all types of AM, FM and ϕ M signals. Although modern radio test sets, test receivers and similar test instruments often possess additional capability for modulation measurements, their accuracy, linearity and dynamic range are in

FIG 1 Modulation Analyzer FAM, microprocessor-controlled and system-capable instrument (IEC/IEEE bus) with automatic tuning for analyzing modulated RF signals.

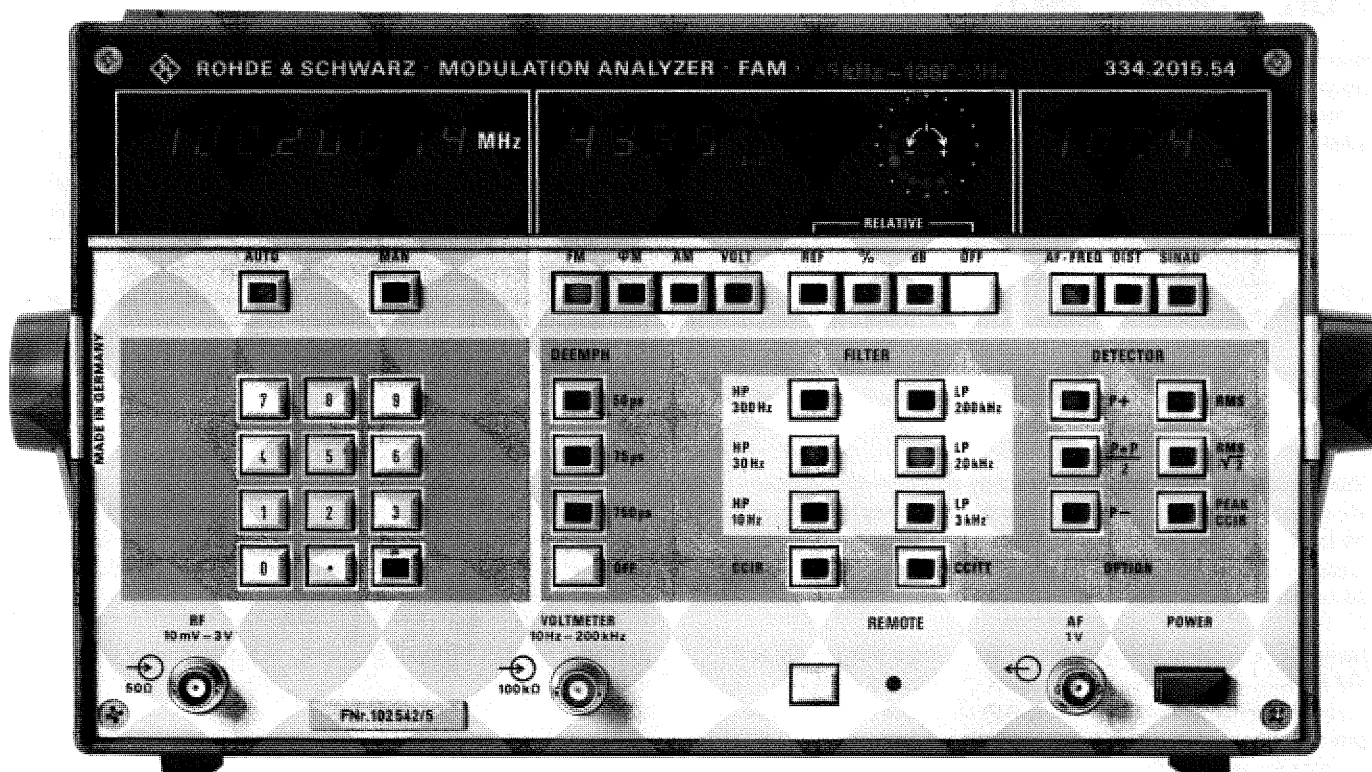

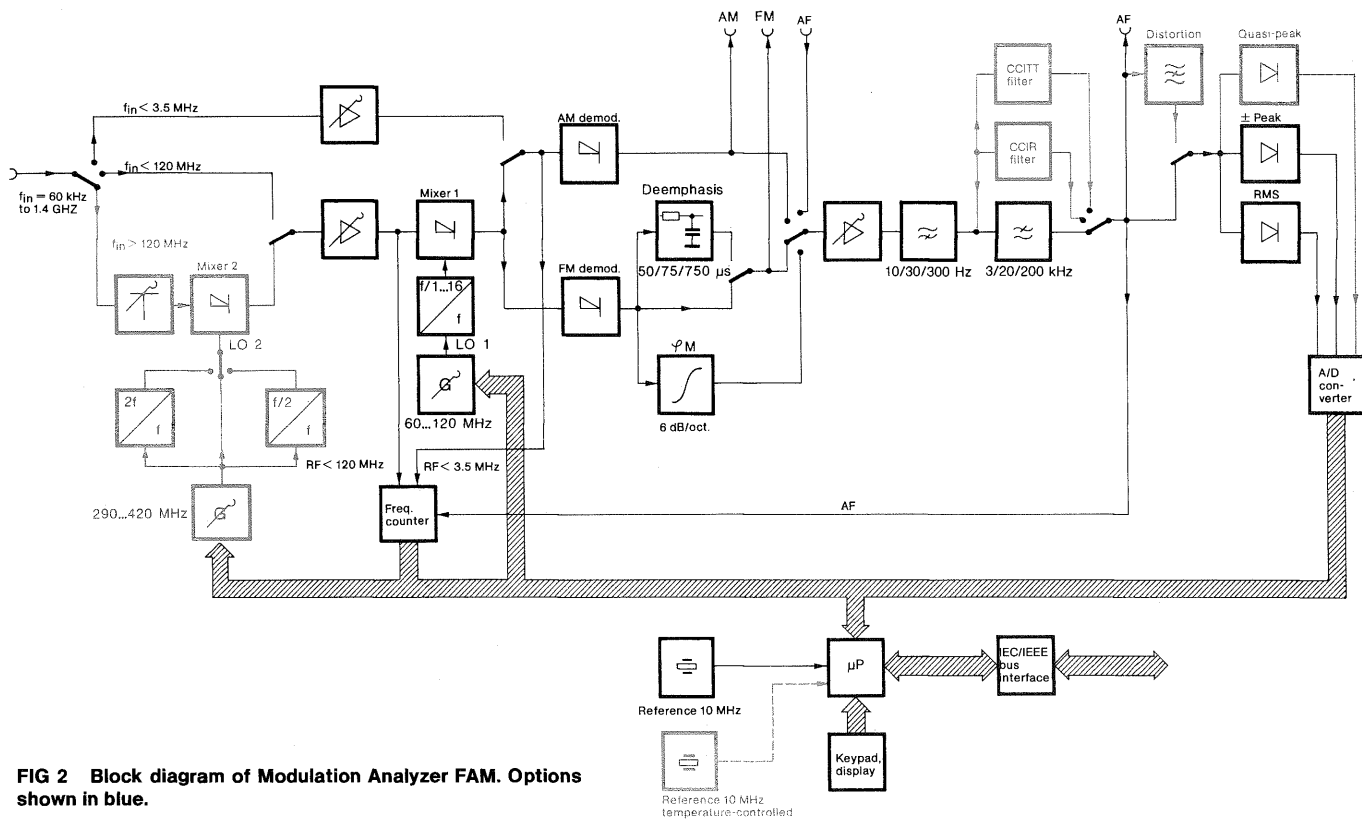

FIG 2 Block diagram of Modulation Analyzer FAM. Options shown in blue.

general limited compared with those of an instrument specifically developed for modulation measurements such as Modulation Analyzer FAM [1].

Functional description

In order to be able to tackle measuring tasks over a broad area such as that of modulation analysis, it is not of course sufficient to measure modulation only. Therefore FAM combines the functions of five separate test instruments:

- RF counter,
- AF counter,
- AF voltmeter,
- psophometer (CCIR/CCITT),
- distortion meter (SINAD).

The overall functioning of FAM is shown in FIG 2, together with the available options. The block diagram is divided into RF, IF and AF stages and the microprocessor control.

The signal to be measured is captured by an **automatic frequency-search routine** in the RF stage and the frequency is counted by the RF counter. Further the RF stage contains an AGC and a mixer. Should several signals be present at the input of FAM, it can be tuned **manually** to the desired frequency.

Signal demodulation is undertaken in the IF stage with the AM and FM demodulators. Thereafter the signal is evaluated in the AF stage. All instrument settings, measurements, data input and output of the keypad and display respectively are performed under microprocessor control.

Characteristics

With regard to linearity and residual modulation FAM displays excellent values. **Accurate measurements of spurious modulation** are easy to carry out as the **residual FM** of FAM within its basic frequency range weighted to CCITT amounts to less than 1 Hz, and less than 5 Hz with a 20 kHz weighting bandwidth. Its **residual AM** is very low at 0.01%.

Precise measurements of signal/noise ratio, for example on FM broadcast transmitters, are no problem at all, especially as the **FM stereo signal/noise ratio** of FAM amounts to 72 dB, weighted to CCITT and referred to 40 kHz deviation. High demands on transfer linearity, as are made on test instruments by modulation methods with large bandwidths, are of course fulfilled. The excellent amplitude and phase linearity permit the **demodulation of multiplex signals without distortion**. Distortion of less than 0.1% as well as 50 dB stereo crosstalk attenuation are values which speak for themselves [2].

Ease of operation

For ease of operation and clear presentation of results, the front panel of FAM is provided with three functionally divided setting and display sections. Thus several parameters can be displayed **simultaneously** without having to switch over:

Lefthand section: RF input frequency or set frequency with manual tuning.

Middle section: modulation result, AF input voltage or relative indication.

Righthand section: AF modulation frequency, AF frequency measurement, distortion or SINAD value (at 30 fixed frequencies).

Software-backed special functions simplify both manual operation and fully automatic control (IEC/IEEE bus).

These are:

- Sidebands changed over (S1)
- Peak hold (S2)
- Freezing of all internal settings (S3)
- Input of distortion test frequency (S4)
- Programming of RF level attenuator (S5)
- Programming of the modulation and voltage range (S6)
- Triggered measurement of RF and modulation (S7)
- Triggered measurement of RF, modulation and AF (S8)
- RF frequency resolution 1 Hz (S9)

High measurement speeds can be achieved with the special functions S3 to S8.

Applications

Along with standard measurements of AM, FM, and ϕ M signals, as well as AF analysis with switchable CCIR and CCITT weighting, FAM is suited for a large number of applications due to its excellent characteristics [3]. On the whole these cover the following areas: selective-call measurements (FIG 3), transient times for switch-on/off of transmitters, crossmodulation measurements using the two-tone method, measurements of transmitter beacons and traffic

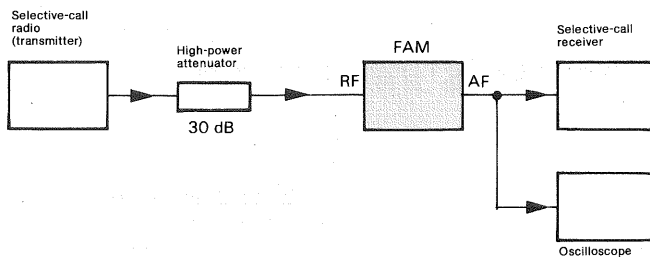

FIG 3 Setup for measurements on selective-call radios.

broadcast signals, measurements on FM stereo signals, station monitor for AM and FM broadcasting stations, phase-noise measurements and measurements on systems and installations.

Philip McDouall

REFERENCES

- [1] Burkhart, D.; Minihold, R.: Modulation Analyzer for 55 kHz to 1.36 GHz. News from Rohde & Schwarz (1980) No. 89, pp. 4-7.
- [2] Schreyer, W.: Analysator mit NF-Messmöglichkeit. Markt & Technik (1982) No. 13, pp. 38-39.
- [3] Rohde & Schwarz Info: Applications of Modulation Measurements. No. 001 122 (1984).

CONDENSED DATA MODULATION ANALYZER FAM

Carrier-frequency range	55 kHz to 1360 MHz
Resolution	10 Hz
FM	
Frequency range	10 Hz to 200 kHz
Deviation	≤ 500 kHz
Display error	$\leq \pm 1.5\%$ (dev. ≤ 100 kHz, $f_{\text{mod}} = 30$ Hz to 60 kHz)
AM	
Frequency range	10 Hz to 200 kHz
Modulation depth	$\leq 99\%$
Display error	$\leq \pm 2\%$ ($m \leq 80\%$, $f_{\text{mod}} = 30$ Hz to 60 kHz)
ϕM	
Frequency range	300 Hz to 20 kHz
Deviation	≤ 500 rad
Display error	$\leq \pm 3.5\%$
AF	
Frequency range	10 Hz to 200 kHz
Resolution	0.1 Hz
AF filters	
Highpass	10/30/300 Hz
Lowpass	3/20/200 kHz
Weighting filters (option)	CCIR, CCITT
AF detectors	\pm peak, RMS, quasi-peak
Other options	distortion meter, OCXO
Ordering number	334.2015.54

Rohde & Schwarz power meters like the NAP and NAUS can be used to advantage in the measurement of incident and reflected power, standing-wave ratio, reflection coefficient, modulation depth and many other factors. Since the meters function according to the directional-coupler principle, they enable simultaneous checking of, for example, transmitter output power as well as of antenna and load matching.

Power and VSWR measurements in radiotelephony

To enable unimpaired radiocommunications, transceiver units and systems for mobile land and air services must provide certain minimum levels of output power. To ensure that the power is actually radiated rather than reflected, the antenna must be matched to the transmitter output. On the other hand, the output power may

not exceed specified maximum values so that mutual interference between different radio networks caused by excessive ranging is avoided. National PTTs, as the responsible bodies for radio sovereignty, control compliance with their regulations by means of various kinds of measuring and test equipment. Only in this way can radio traffic be kept largely interference-free, particularly in densely populated areas.

A graphical illustration of the very intensively utilized frequency range 25 to 1000 MHz will make evident the multitude of radio services operating here (FIG 1).

The measuring-bridge principle

The kind of bridge used in the field of general measurements also finds application in RT testing. Unfortunately, bridges feature serious drawbacks especially as far as power matching is concerned. VSWR bridges absorb most of the applied power and only pass a small part of it to the test item. Thus they act as an attenuator inserted between transmitter and antenna. High powers cannot be measured because of the limited loading capacity, and in the case of mismatch between the load and transmitter, the inserted attenuation causes considerable variation of the matching characteristics.

The directional-coupler principle

In contrast to the VSWR bridge, the Rohde & Schwarz concept of employing a **line directional coupler with defined and high directivity** offers decisive advantages. Owing to the extremely low

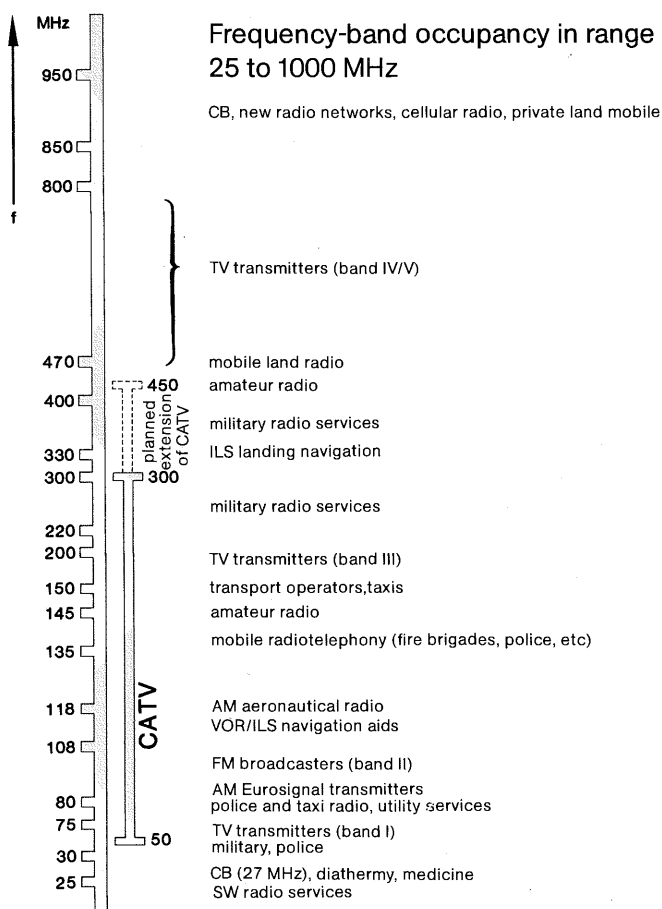

◀ FIG 1 Frequency-band occupancy 25 to 1000 MHz.

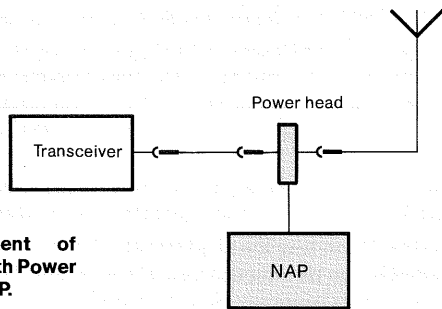

FIG 2 Measurement of VSWR at antenna with Power Reflection Meter NAP.

insertion loss (<0.75 dB), the NAUS and NAP power heads can be connected between the transmitter and its load **without** changing the power transmission and matching characteristics (FIG 2). Measurements are made under normal operating conditions and monitoring is possible during transmission [1].

The directional-coupler power head

The power heads of the NAUS and NAP family of units function according to the **principle of coupled lines**. The input power is fed to the load via the main line with almost no attenuation (FIG 3).

The RF voltages proportional to the incident and reflected power are available at the outputs of the secondary line. The frequency response of the transmission characteristics of the directional coupler over the wide **frequency range 25 to 1000 MHz (1 : 40!)** is balanced by compensation networks.

The now **frequency-independent** RF voltages are rectified by separate diodes. As the diodes operate in the nonlinear range of their characteristics (the low driving power lies 60 dB below the transmission power), **exact RMS evaluation** of the applied RF signals is performed, thus providing a **strictly linear** meter scale for the indicated powers.

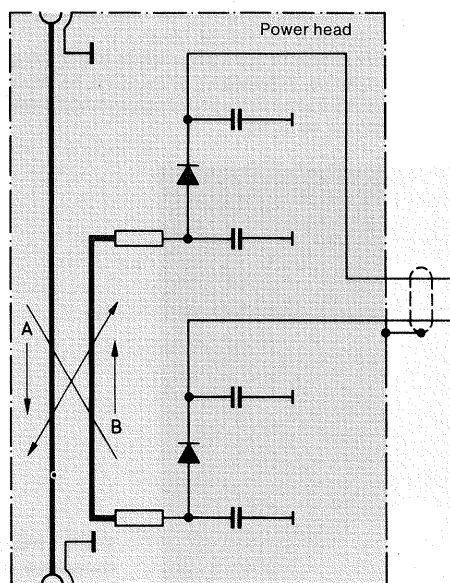

FIG 3 Basic circuit diagram of NAUS power heads.

Even in the case of amplitude-modulated signals with several signals of different frequency applied or in the presence of harmonics, the RMS-responsive rectification ensures correct power indication. High loading capacity of the rectifying diodes through the use of chopper amplifiers and careful thermal compensation yields **very low temperature response** of the indication of <0.25%/°C as well as a total operating range of -20 (-10) to 55°C, which permits use under **extreme ambient conditions** [2].

The **sturdy diecast housing** of the power head with its stable RF connectors [2, 3] ensures high reliability even under the stress of mobile applications.

Since the incident and reflected powers are **simultaneously** detected by two directional couplers and are also taken to **two** meters for indication, there is no need for the usual switchover between incident and reflected power as well as indication on a single meter.

Directional Power Meters NAUS

These units have found use in their thousands all over the world. They are particularly valued for their **high reliability and accuracy**. The four meters NAUS 3/4/5 and 6 cover the power range **20 mW to 1.1 kW**. Each unit of the series in conjunction with its power head can be used to measure in the frequency range 25 to 1000 MHz. The scales of the two indicators are linearly calibrated. The RF-pickup-proof design of the power head and measuring section provide for a **high degree of interference immunity**. FIG 4 shows the Directional Power Meter NAUS 3.

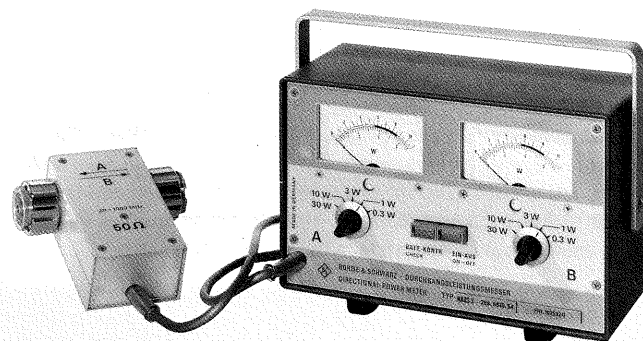

FIG 4 Directional Power Meter NAUS 3.

The meters are powered by five commercial IEC R20 cells (1.5 V). Owing to the very low current drain, a set of batteries has a lifetime of almost **one year** in continuous operation (>7000 operating hours).

Power Reflection Meter NAP

The NAP (FIG 5) combines the design and operation of the well-proven NAUS power heads with state-of-the-art **microprocessor technology** in the display section. Through mathematical combinations of incident and reflected powers, the following quantities can therefore be measured and directly indicated:

- incident and reflected power in W or dBm,
- standing-wave ratio (VSWR),
- reflection coefficient in %,
- reflected-to-incident power ratio in %,
- transmission loss and return loss in dB,
- modulation depth in % with AM,
- deviation of incident and reflected power in % or dB from specified reference values and
- minimum and maximum values of a measurement series.

In addition to these measurement functions, the meter can perform service and special functions.

The measured values are indicated on **two large LCD displays**. Below the 3½-digit display, the two measured values are also indicated in **analog** form by means of a **bar meter** on a **calibrated scale**. The analog display facilitates adjustment procedures – a benefit which is only partly realized with purely digital indication. Practically all measurement functions can be selected with a single keystroke.

The basic NAP model contains six IEC R20 single cells (1.5 V) with a lifetime of **500 hours** as its power source. This long service life is attributed to a newly developed microprocessor using state-of-the-art CHMOS circuits. Further factors contributing to the very low power consumption of the unit are a special operating mode of the microprocessor, the exclusive use of CMOS ICs for the digital circuitry and implementation of low-power circuits in the analog section. In addition, the unit switches off **automatically** if it is not used for half an hour. The automatic switch-off can, if required, be disabled by a special function [1].

Instead of the round cells the **option NAP-B4** can be fitted. This comprises a power-supply section for connecting to an AC supply (100 to 120 V, 220 to 240 V), an **IEC/IEEE-bus interface** and rechargeable **nickel-cadmium storage batteries**, which enables the NAP to be used in mobile operation in this configuration also.

The IEC/IEEE bus makes the NAP **system-capable**: via the bus measurement and special functions can be set, and the results obtained can be read out. This offers a variety of applications, for example the automatic monitoring of unattended transmitters with the aid of process controllers such as the PUC or PCA from R&S.

The analog outputs for incident and reflected power on the rear permit the **connection of a recorder** and therefore the tracing of curves. In this way the longterm stability of transmitter stages for example can be checked very simply. In addition, intermittent faults of test items are easier to detect.

The fact that the power heads of the NAP are plugged onto the display section opens up further uses. With a view to problemfree measurements in the vicinity of antennas and transmitters, the display section and power heads of the NAP are of RF-screened construction. The **Extension Cable NAP-Z2** permits the detached use of power heads up to a distance of **25 m**. The **automatic** identification of the power head by the display section is in this case not affected.

The universal basic concept of the Power Reflection Meter NAP opens up many possibilities for future system extension.

Klaus Thomé

REFERENCES

- [1] Löser, A.: Power Reflection Meter NAP for SWR measurements. New from Rohde & Schwarz (1984) No. 106, pp. 9–11.
- [2] Burkhart, D.: Directional Power Meters NAUS 3 and NAUS 4 reach 1000 MHz. News from Rohde & Schwarz (1977) No. 79, pp. 36/37.
- [3] Löser, A.: Directional Power Meters NAUS 5 and NAUS 6. News from Rohde & Schwarz (1981) No. 93, p. 35.

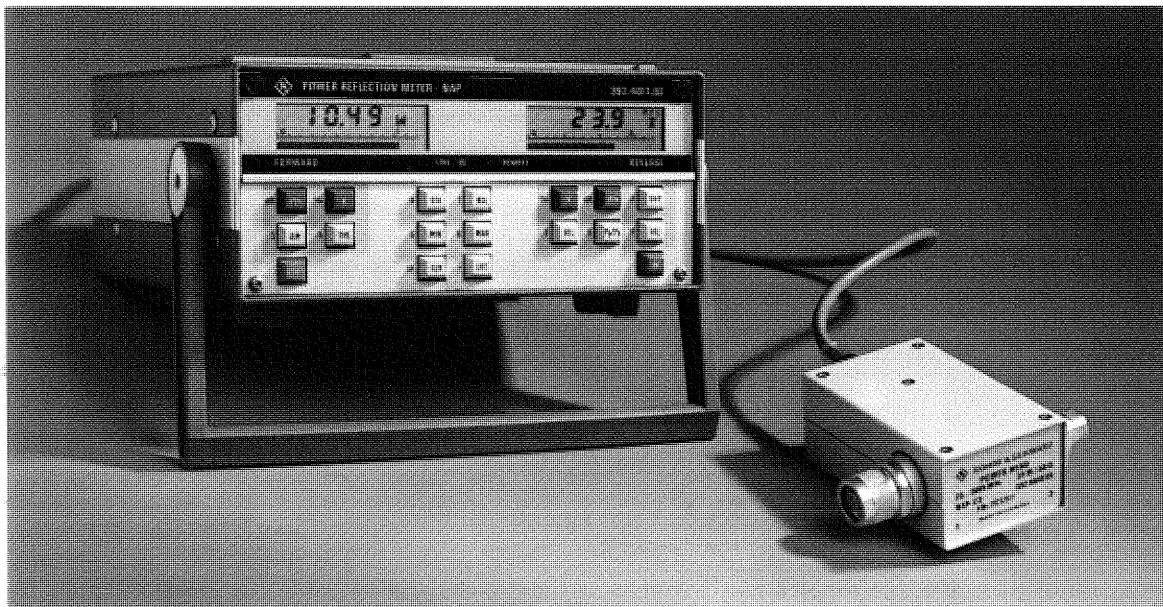
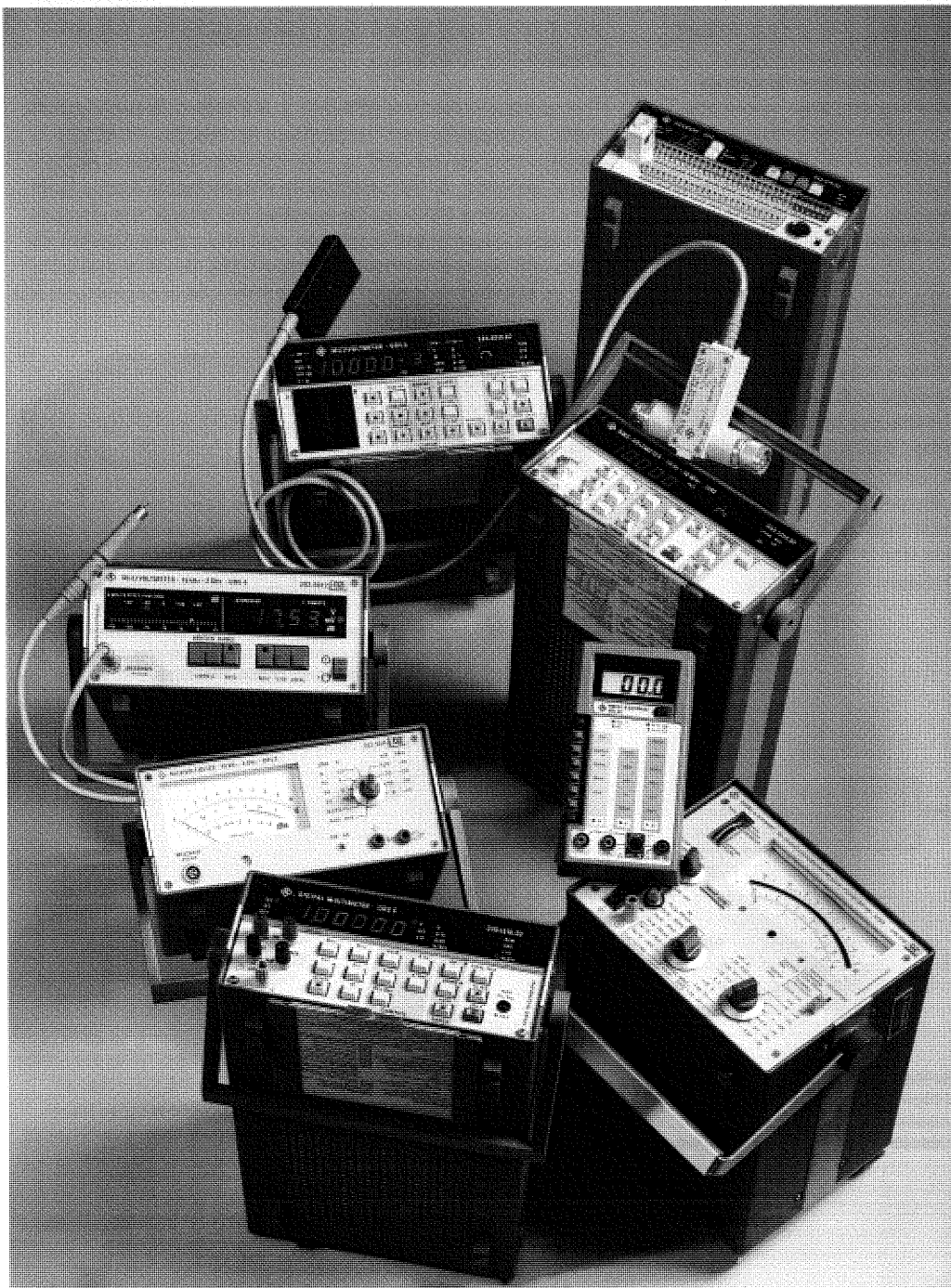

FIG 5 Power meter NAP for frequency range 25 to 1000 MHz measures 20 mW to 1,100 W with four detachable power heads.

Whether 0.2 μV or 40000 V, 1 pA or 1000 A, Rohde & Schwarz has the right measuring instrument for all values within these limits. Instruments of various accuracy classes from simple handheld multimeters to high-precision system voltmeters are available, no matter whether DC or RF signals up to 18 GHz are to be measured. The multimeters are also capable of resistance measurements from m Ω to M Ω .

RF, AF and DC voltmeters from Rohde & Schwarz



Voltmeters are part of the basic equipment of any test bench in all fields of engineering. The wide range of different applications is reflected in various demands for accuracy, resolution, measurement speed, size, price, etc. The R&S line of voltmeters (FIG 1) includes the right instrument for any application.

FIG 1
Rohde & Schwarz voltmeter line with Scanner UVZ (at the back).

DC voltmeters and multimeters

The analog **DC Microvoltmeter UIG** is able to indicate values as small as $0.2 \mu\text{V}$ or 1 pA . This permits, for instance, the detection of minute reverse currents in semiconductors or unwanted thermoelectric voltages in circuits or at contacts. The UIG is supplied from a battery of course, making it suitable for completely off-earth operation.

The group of digital multimeters (DMMs) permits measurements above $1 \mu\text{V}$ to be made. The upper range limit of 1000 V may be extended to 40 kV with the aid of a high-voltage probe. Using clamp-on probes currents up to 1000 A can be measured without tapping cables.

For mobile use and service there are the high-grade **Digital Multimeters UDL 33 and UDL 4**. The star among the DMMs is the $5\frac{1}{2}$ -digit, microprocessor-controlled **Digital Multimeter UDS 5**. It stores calibration data for all subranges, and these values are considered in the accurate determination of measurement results. Furthermore, in the most sensitive measurement range linearity corrections produce an indicated value that is to a very large extent free from any errors caused by the inherent noise of the instrument. Other tasks of the microprocessor that does all this are continuous offset monitoring and correction as well as functional checking of the individual subassemblies and the processing of any error messages. This ensures the high accuracy and longterm stability of the UDS 5.

High sensitivity and immunity to interference in a measuring instrument are always at the expense of the measurement rate, but it is precisely speed that is of great importance in automatic test systems. For this reason the measurement rate of the UDS 5 can be varied and optimally matched to the respective application. This is a feature of all microprocessor-controlled R&S voltmeters by the way. Very low-frequency AC voltages (below 10 Hz) are sampled in point-by-point measurements using the fast UDS 5 ($80 \text{ measurements/s}$). Calculation of the rms value is made by a system controller with freely selectable integration time (FIG 2). Thus the entire frequency range down to DC voltages is covered.

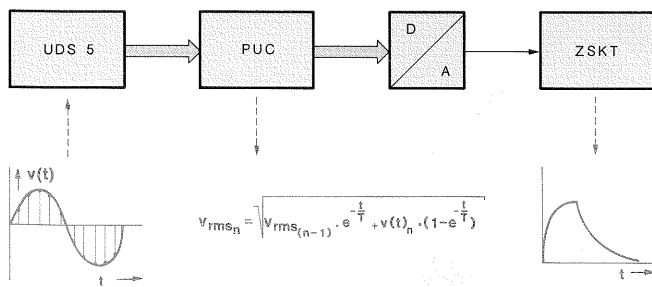

FIG 2 Determining rms value of very low-frequency signals in point-by-point measurements using high-speed Digital Multimeter UDS 5. Time response of rms value calculated by controller may be recorded via D/A converter (here transient response and decay after switching signal on and off).

AF and broadband instruments

The $4\frac{1}{2}$ -digit **RMS Voltmeter URE** with its special rectifier circuit permits true-rms measurements with a wide bandwidth in the frequency range 10 Hz to 20 MHz – and this up to 30 times per second. Series of measurements, as required for determining the transmission characteristics of twoports for instance, can be carried out rapidly and exactly with this instrument. Similar to the UDS 5, the fast measurement mode of the URE permits rms values as well as the maximum and minimum of signals modulated at low frequencies to be determined.

Among the AF measuring instruments from R&S the **Psophometer UPGR** is particularly worth mentioning. This psophometer, which is also designed for mobile use, permits weighted and unweighted noise measurements according to CCIR, CCITT and DIN standards to be carried out besides wideband measurements up to 100 kHz . Because of its excellent accuracy and wide measurement range the UPGR is highly appreciated by postal authorities and radio-broadcasting studios.

The new **Audio Analyzer UPA** (FIG 3) is a system-capable psophometer. In conjunction with appropriate options this IEC/IEEE-bus psophometer can be used as a low-distortion generator, psophometer, distortion, SINAD and wow-and-flutter meter. A large number of weighting filters can be switched into circuit. The absolute or relative values of test results are read off on three different displays with digital and analog indications. The inputs and outputs can be selected via internal relays as balanced or unbalanced and with different input impedances.

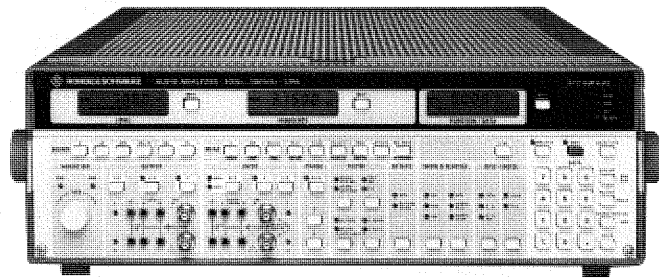

FIG 3 Audio Analyzer UPA is a system-capable psophometer which, together with various options, can be used as a low-distortion AF generator, distortion, SINAD or wow-and-flutter meter and, of course, as a psophometer.

can be selected via internal relays as balanced or unbalanced and with different input impedances.

RF voltmeters

Rohde & Schwarz has been producing RF voltmeters for as long as the company itself has existed. From the very beginning the instruments have exhibited exceptional characteristics. Decades of experience and consistent use of the latest technologies have gone into perfecting these RF voltmeters. The present **series URV, URV 3 and URV 4** are being used all over the world. One of the rea-

sons for this popularity is the large variety of available probes and their special circuitry (bridge compensation of rectifier diodes and their linearizing effect), permitting an interchange of probes.

The youngest member of this family, the URV 5, may with good reason be described as the most modern RF voltmeter presently on the world market. With this instrument a new generation of "intelligent" probes is being used for the first time. What is so special about them is that the data determined in their calibration are stored in an EPROM fitted in the plug and continually used as correction values during measurements. This applies to level and frequency as well as to temperature. The result is unequalled accuracy and – closely related to this – excellent repeatability of test results. Digital memories for storing the calibration data are not affected by mechanical influences or climatic conditions; they are insensitive to shock and will not age. The accuracy is maintained over long periods of time; regular recalibration is not required. This means that the technique of digital calibration reduces the costs for the customer.

The microprocessor in the URV 5 not only handles the usual control and monitoring tasks, it also evaluates the measurement data at both inputs almost simultaneously, relates them and calculates their level differences either in dB or % as required. Different probes may be connected to the two channels, even a combination of an RF and a DC probe is possible. Thus not only the attenuation characteristics of twoports, filters or lines, but also the transient response of converters, demodulators, etc can all be measured in a single process. Long measurement sequences may be evaluated by a controller via the built-in IEC/IEEE bus. Six measurement rates with a maximum of 25 measurements/s can be selected.

Scanners

The need to measure voltages or currents simultaneously at several points of a system occurs quite often. Changing connections all the time is out of the question, at least as far as series measurements are concerned. In cases like this a checkpoint selector can avoid the considerable cost involved in providing whole batteries of voltmeters. With the aid of such a scanner the required connections between source and instrument can be established in no time at all (FIG 3). A scanner may be used for measuring any parameters that a digital multimeter can handle (up into the MHz range).

The **Scanner UVZ** (see FIG 1) has 48 freely selectable switching contacts grouped in either three- or six-pole channels. The built-in IEC/IEEE bus is an essential part of this unit, permitting the high switching rates to be made full use of. Via this IEC/IEEE bus several channels may be programmed simultaneously. As many scanners can be stacked as there are IEC/IEEE-bus addresses available. This opens up a wide range of applications. Other special features – recently certified by the Federal-German office of standards – are the extremely low thermoelectric voltages (fractions of μV) and the low-capacitance design.

Alfred Weinberger

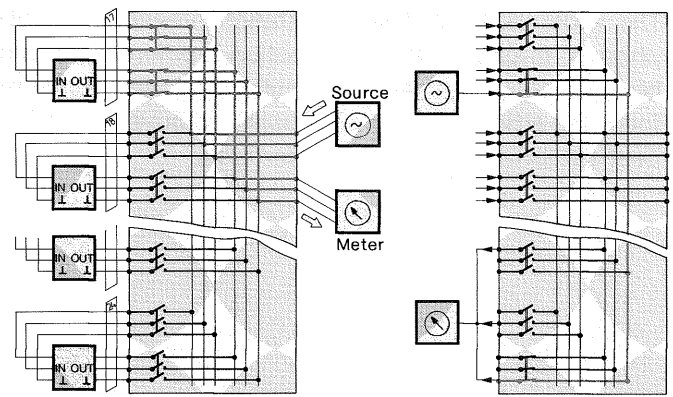

FIG 4 Left: basic circuit layout using Scanner UVZ to measure filter bank. Low-capacitance design of UVZ permits transmission of input and output signals in same channel. Up to eight twoports (+ guard) may be switched with one scanner. Right: switching of individual lines: In IEC/IEEE-bus operation UVZ is able to activate several channels simultaneously. It thus offers 39 single-pole channels; 48 channels may be added with each additional scanner.

R & S VOLTMETERS

DC Microvoltmeter UIG	0.2 μV to 320 V (30 kV) 1 pA to 320 mA
Digital Multimeter UDS 5	1 μV to 1200 V 100 nA to 1.6 A 1 m Ω to 20 M Ω
Digital Multimeter UDL 33	100 μV to 1000 V 1 μA to 10 A 100 m Ω to 20 M Ω
Digital Multimeter UDL 4	10 μV to 1200 V 10 nA to 2 A
RMS Voltmeter URE	50 μV to 300 V (DC, 10 Hz to 20 MHz)
Psophometer UPGR	3 μV to 350 V (15 Hz to 100 kHz)
Audio Analyzer UPA	1 μV to 300 V (10 Hz to 100 kHz)
RF DC Millivoltmeter URV	50 μV to 1050 V (DC, 10 kHz to 2 GHz)
Millivoltmeter URV 3	700 μV to 1050 V (10 kHz to 2 GHz)
Millivoltmeter URV 4	700 μV to 1000 V (10 kHz to 2 GHz)
Millivoltmeter URV 5	200 μV to 1000 V (DC, 9 kHz to 18 GHz)

The wide choice of instrumentation presently available for testing radiotelephones, ranging from a combination of different instruments right up to comprehensive test sets, makes it difficult for the user to select suitable equipment. The following article will give both user and buyer some assistance in choosing the best equipment for their requirements.

Multi-function test set or discrete instrumentation?

Each aspect of work in radiotelephony engineering, whether it be development, production, acceptance tests, quality assurance or repair, makes **different demands** on the measurement equipment used. For example, the development engineer wants a signal generator to have a wide dynamic range and low noise in order to examine a new circuit right down to the last detail while a service technician is satisfied with more moderate performance. On the other hand, ease of operation combined with quick results is most important in the servicing workshop – there is no time here for the whimsical but often necessary exercises of the ambitious development engineer.

Modern measuring equipment offers a **high standard of operating facilities** and **excellent technical specifications** by incorporating up-to-date technology like **synthesizer circuits** and **microprocessors**. But for each application there must be a compromise between the required performance and the overall cost of the equipment. The financial outlay cannot simply be expressed by the purchase price because contributory factors must be taken into account such as **reliability** (maintenance costs), **speed of measurement** (total throughput) and **ease of operation** (reflected in the level of training or education of the operator).

Instrument intelligence simplifies operation

Nearly all modern measuring instruments incorporate a microprocessor which endows the equipment with more or less **intelligent functions** without having to use an external control computer. Signal generators can therefore **store** a wide variety of **settings**, which can be called up when required by pressing a button. Voltmeters not only give readings in the usual units of measurement (V, mV, dBm) but also in relative units (dB and $\Delta\%$ with reference to a chosen datum).

FIG 1 shows a setup assembled from the single pieces of equipment necessary for measurements in radiotelephony. Seen as a whole, such a setup appears to have a high degree of intelligence, but one must note that the **intrinsic intelligence is so distributed** that it is hardly of any use when making measurements that are typical in radiotelephony. Each interaction between the different instruments has to be from outside the setup – either manually or automatically from a computer over an IEC/IEEE bus.

In contrast to having individual units of equipment, the multi-function test set is actually a combination of all the instruments needed for measurements on radiotelephones. FIG 2 shows how this results in a form of **“centralized” intelligence**. Using this method, the microprocessor embodied in the test set can process complicated series of measurements which require the coordination of several instruments, and it can do this **without** any manual or automatic **control from outside**. In addition, there is an integral interface for controlling the functions of the radio, thereby ensuring selection of the correct mode of operation (eg transmission/reception, squelch on/off, etc) for each measurement. If the test set has a **special memory area for the customer’s own programs** (eg Autorun Control/Printer Interface CMT-B5), it is possible to take an **entire sequence of measurements** and **record** them **fully automatically** on a printer without having to use an external computer.

Technical specifications as the deciding factor

The evaluation of suitable test sets from different manufacturers often starts with a comparison of the most salient technical features. For sets within the same price range, this is certainly a useful way of deciding which is the better set. However, the first and fore-

FIG 1 Test setup comprising single items of equipment has distributed intelligence: instruments can only interact with one another if there is outside control (man or machine).

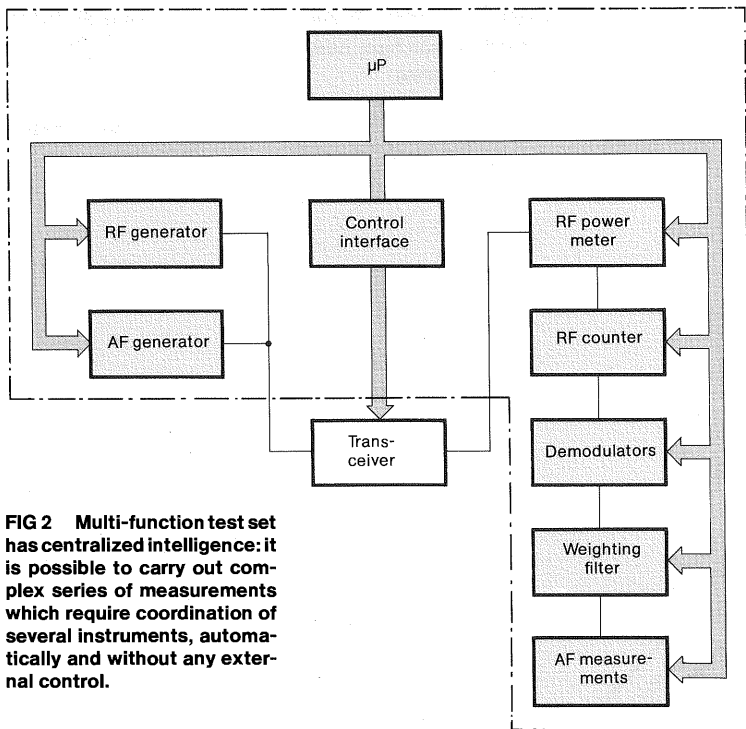
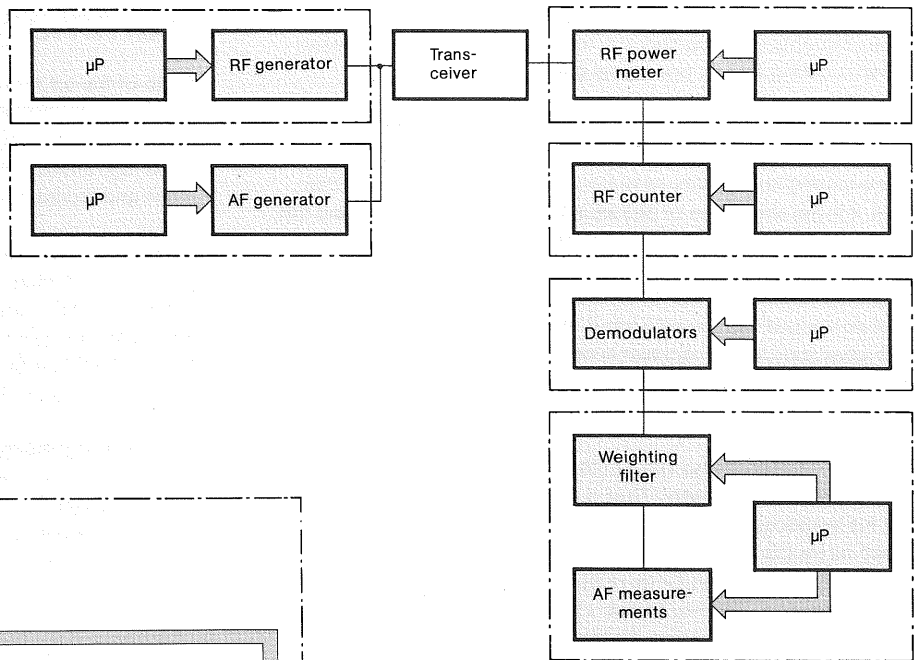

FIG 2 Multi-function test set has centralized intelligence: it is possible to carry out complex series of measurements which require coordination of several instruments, automatically and without any external control.

most consideration should be the suitability of a set for the intended task of measurement rather than just the level of the technical data.

It is important, especially when assembling test sets using discrete items of equipment, to ensure that the performance of the instruments is mutually compatible. For example, the extra cost of an audio analyzer measuring SINAD values up to 65 dB cannot be justified as long as the accompanying signal generator has modulation distortion of 1%, which limits SINAD measurement to a maximum of 40 dB. Users who assemble their own combination of measuring equipment are ultimately responsible for seeing that the performance of the individual instruments is effectively achieved in practice.

In a multi-function test set, the job of matching the data has already been done by the designer of the equipment.

Even the electrical connections between the different instruments can have a marked negative effect on the specified data. A classic example of this is when an accurate and sensitive RF power meter

is used. To measure the typical power output of radio equipment (from 2 to 50 W), attenuator pads must be included in the test circuit. Careful assembly of the measurement apparatus and extra work on calibration will be needed to ensure that the high accuracy of the power meter is not lost through uncertainties caused by reflection or attenuation of the signal. With an integrated test set, this has already been taken into account in the design of the equipment. The user can plug his radio straight into the test set, knowing that he can rely on the accuracy laid down in the data sheet without corrections to the readings.

Is it worthwhile moving to a test system?

Both the multi-function test set and the simple combination of discrete measuring instruments offers testing capability which, as a rule, is quite sufficient for the needs of production, repair and

maintenance. This equipment allows all the so-called in-channel measurements to be carried out, meaning those receiver measurements calling for just one signal generator.

The postal regulations of most countries require an even more extensive range of measurements in the development, acceptance testing and quality assurance of radio equipment. In this work, it is the simulation of disturbances that takes priority and this is achieved by employing a second radio-frequency signal generator so that measurements can be made of adjacent-channel selectivity, intermodulation, etc. Measurements to determine the interference caused by the radio itself also form part of these more extensive tests. A test receiver is necessary for this task (see NEWS special 1 "Signal-strength and interference measurements").

Test stations may not be used exclusively for measurements on radiotelephony equipment. Thus a manufacturer might want to test his broadcast receivers or stereo equipment at the same bench as his CB and mobile-radio products. The extra workload provides a good reason for developing a simple test set into a complex system. The key to this is the now indispensable IEC 625/IEEE 488 interface bus. All kinds of equipment can be operated over the bus from a central controller, thus combining the instruments to a complete system operated from the computer. Even when a system is chosen, it may still make good sense to use the multi-function test set as the heart of the installation. Its performance is good enough for a much wider range of measurements and, in addition, the switch matrix can save much effort during system integration. Finally, it greatly simplifies the software if all the functions of an instrument are combined at one address on the bus.

Even in the context of a system it will often be possible to use resident, intelligent measuring routines of the multi-function test set. The decision, therefore, to build a measuring system out of discrete instruments can only be justified where there are stringent requirements regarding the degree of flexibility, the scope of testing and the accuracy of the measurements.

Summary

State-of-the-art measurement technology offers equipment with excellent specifications and operating features which were inconceivable some years ago. Even a manual test set is distinguished by its high intelligence in the form of semi-automatic measurement and stored settings.

Test sets with an integral autorun control can even perform complete tests on radio equipment and record the results without the assistance of an external computer. Comprehensive measurement systems can be assembled without any great difficulty on the IEC/IEEE bus by using a multi-function test set together with additional instruments.

For the utmost flexibility, high accuracy and the widest scope of testing, measurement systems can also be assembled using top-quality discrete instruments. To give a better overall view, the table relates the criteria which have been discussed to the possible equipment configurations.

David Picken

		Manual multi-function test set	Multi-function with autorun control	Measuring system test set and extra instruments	Measuring system comprising discrete instrumentation	Measuring system comprising
Development	Circuit development	●				○
	Continuous tests (eg temperature cycles)				●	
	PTT acceptance					●
Production	Module alignment	○		●		
	Equipment alignment			●		
	Final equipment test			○	●	○
	Quality assurance					●
Service	Incoming/outgoing inspection			●	○	
	Routine maintenance			●		
	Repair	●				

● Recommended solution ○ Possible solution

TABLE for choosing most suitable test configuration for work in development, production and servicing.



application notes

Automatic test assemblies for laboratory and acceptance testing

Two examples illustrate concepts of automatic test assemblies suitable for testing modules and for final and acceptance tests on **AM, FM, ϕ M and SSB transceivers**. These test systems were conceived and supplied as part of customer contracts. The two system concepts differ essentially in the scope of measurement capabilities, the adaptation of the test item and the software itself. The basic measurement quality is the same in both

systems since it is determined by published standards and the technically advanced state of the test items. FIG 1 shows an automatic test assembly for military maintenance level 3/4.

The tasks to be fulfilled can be divided into two groups, ie testing of modules and final units in the laboratory and acceptance testing on completed units.

The laboratory test assembly

Transceiver tests using a **laboratory test assembly** are needed at all stages of the development process, eg basic **investigations on modules** such as filters, duplexers, oscillators and digital control circuits or on **subassemblies** such as IF boards, RF output amplifiers and synthesizers

FIG 1 Automatic test assembly in laboratory for testing modules and acceptance tests on transceivers.

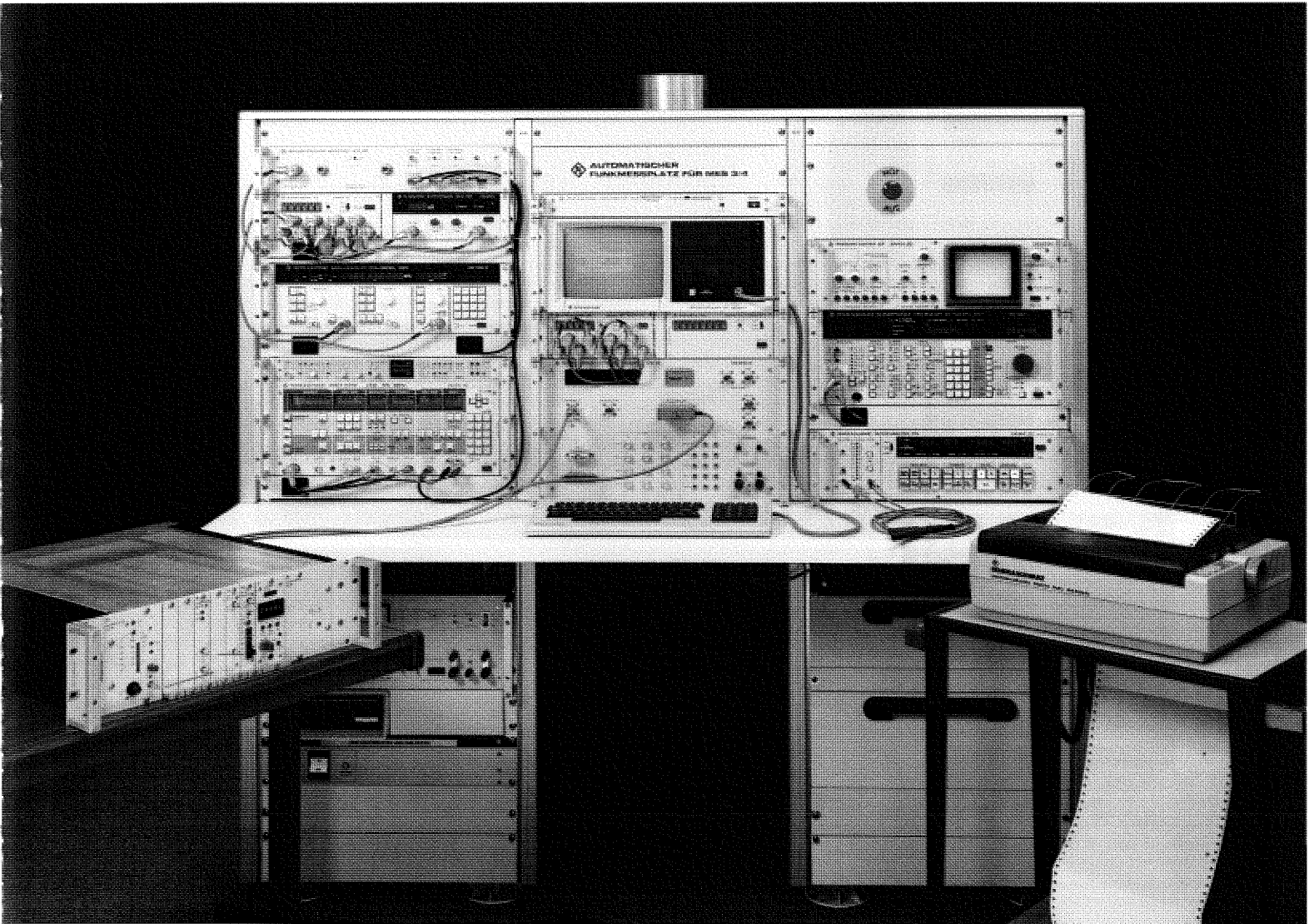

through to transmitter and receiver sections or **complete transceivers**.

At this time those characteristics of modules and transceivers are of particular interest that are not measured later in the final test of batch-produced units. This is important in the case of characteristics which are attained in the end-product through specific measures in development and cannot be integrated into the end-product, regardless of the complexity of measurements made at a later stage. Other transceiver characteristics are determined in the series final test by indirect measurements since direct measurements are too complex in this case.

Selective RF measurements and most **impedance measurements** are examples of this group of characteristics. The latter are performed with vector-analyzer test assemblies in the laboratory whereas in the final test RF power measurements under matched conditions suffice.

In the course of development and for repairs the object of tests is often just a single module. As modern transceivers are mostly **digitally** controlled internally, the test system must supply the control inputs with appropriate signals since the modules cannot otherwise function properly. The same also applies to the **provi-**

sion of analog signals to the modules that are not apparent in the complete transceiver. The signal paths from and to the modules must be flexible and if anything generously dimensioned in comparison to the requirements for the final test of transceivers.

During development the defined interface characteristics are controlled step by step and recorded in order to document every stage of development. As far as the measuring technique is concerned, this means that in most cases a parameter is tested merely as a function of one or several input parameters for a specified hardware status. These measurement procedures are relatively simple and can frequently be repeated, **logging in the form of graphs** being the preferred method of documentation.

The system software must satisfy requirements for simple callup of a variety of measurement functions and for recording in terms of graphs and tables. The **system instrumentation** must be able to accommodate the connection of the test item equally **as a system unit within the framework of the transceiver tests** and **as a stand-alone unit to the required extent**.

Following the laboratory testing of modules, the complete unit is tested for **rated values** at the end of the development stage. This is performed in the laboratory at a **greater test depth** than stipulated by published standards. The manufacturer thereby obtains **greater reliability** for his **data-sheet specifications**.

The system software for this type of measurement must be capable of permitting a multitude of partly **complex, single measurements** to be run in **freely selectable sequences** without the burden of extensive programming and debugging.

Apart from computer-controlled test runs on modules and final units, it should also be possible for laboratory test assemblies to carry out **manual measurements** for the **rapid check** of test methods or one-off checks that do not call for certification.

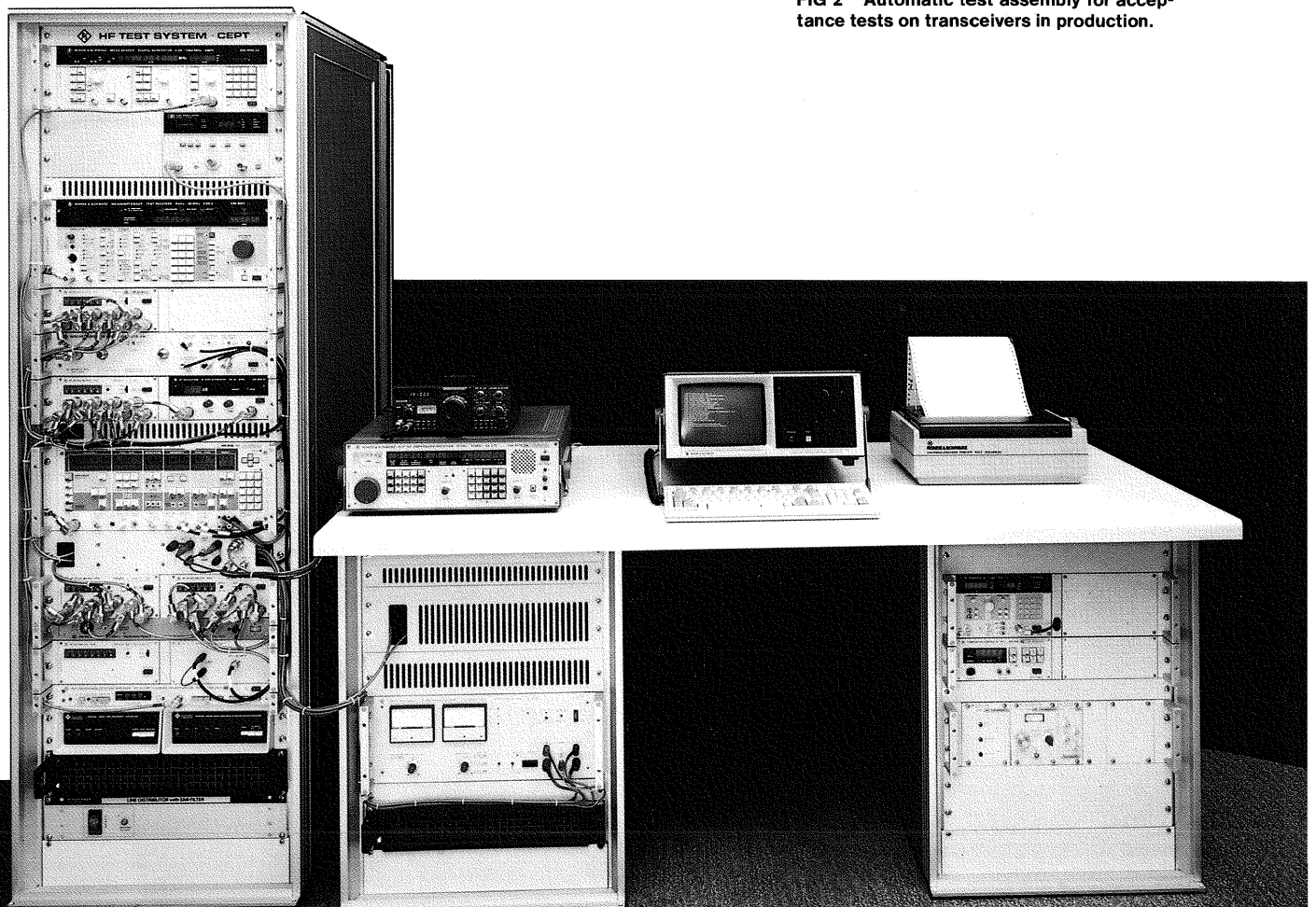

FIG 2 Automatic test assembly for acceptance tests on transceivers in production.

The acceptance test assembly

In contrast to the laboratory test assembly, the **acceptance test assembly** for transceivers has a simpler configuration, ie it does not need the high degree of flexibility for adapting the test item within the system, and vector analysis is in most cases not required.

If the acceptance test system is conceived for only one transceiver family and

writing of programs at different depths of testing. Example: all measurements in line with **CEPT recommendations** or only selected parts of them.

Practical examples

During the course of 1984 and 1985 the following automatic systems for testing modules and final units in the laboratory (FIG 1) and for acceptance testing in line

● Test system for acceptance tests in production

Brief details: measurements on AM, FM, ϕ M and SSB transceivers up to 100 W, frequency range 400 kHz to 1 GHz, two-signal measurements up to 1360 MHz, sideband analyses with 100-Hz test bandwidth, adjacent-channel power meter with 86 dB dynamic range, selective RF measurements from 9 kHz to 30 MHz (especially SSB).

The configuration of the two test systems is **tailored** to customer requirements.

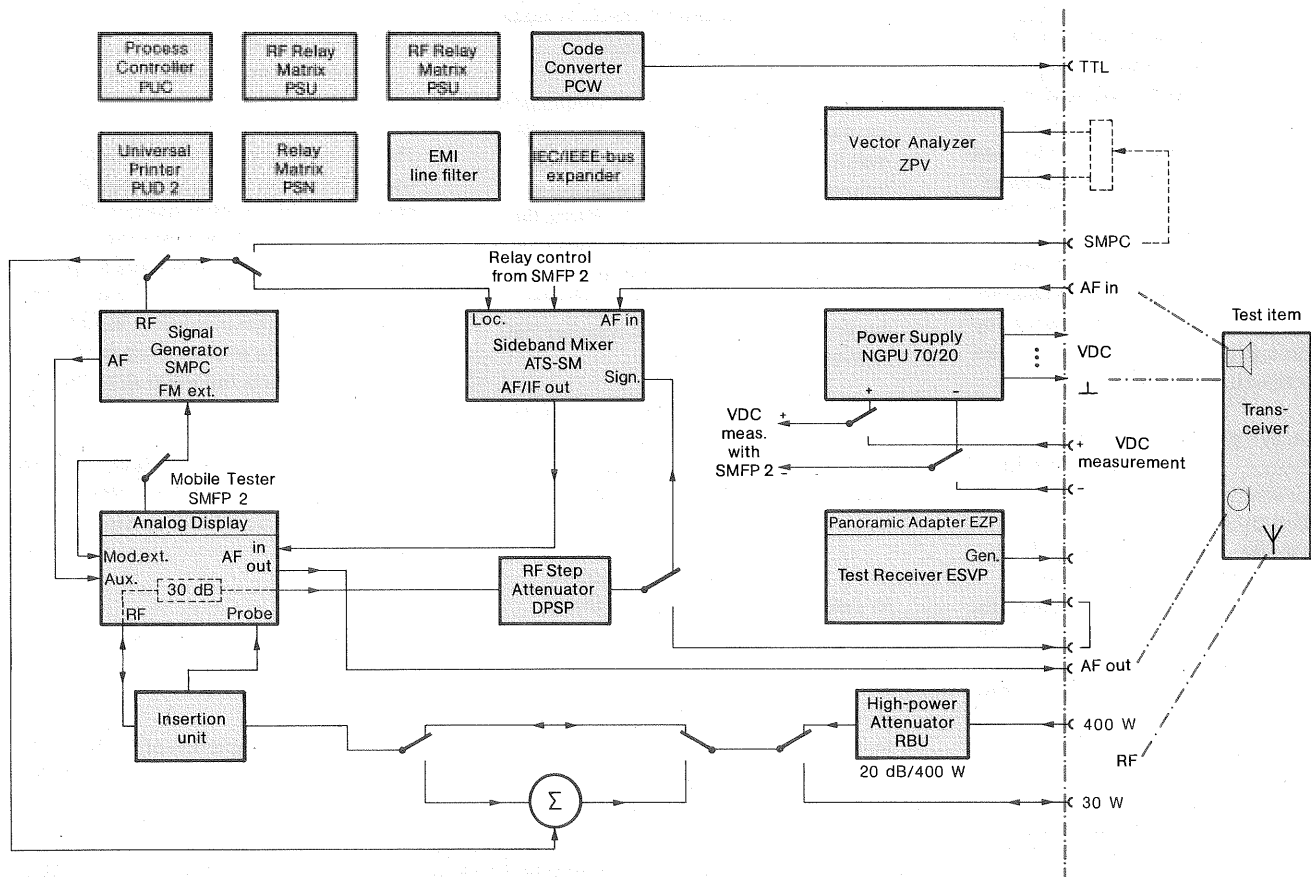

FIG 3 Block diagram of automatic test assembly as shown in figure 1.

is planned for use over an extended period of time, it can be of advantage to incorporate a **transceiver-specific test adapter** into the system. The test-item **interfacing** of a system for official acceptance testing must preferably have **general application** since test items are expected to be constantly changed.

Acceptance tests are run at the manufacturer's and at an officially approved test centre (eg type testing) in line with **standards in force**. In this case, just as for the laboratory test assembly, it is imperative that measurements be **reproducible** and produced with the highest accuracy. The system software must afford the simple

with CEPT (FIG 2) were supplied and put into operation:

● Test system for modules and final laboratory test on transceivers

Brief details: measurements on AM, FM, ϕ M and SSB transceivers and modules up to 400 W; frequency range 400 kHz to 1 GHz, two-signal measurements up to 1360 MHz, sideband analyses with 100-Hz test bandwidth, selective measurements from 20 to 1300 MHz, vector analyses from 100 kHz to 1 GHz. The system can be retrofitted for mobile use.

Whilst the first system is optimized for VHF and UHF transceivers and modules, the second system mainly finds application for SSB units. Common features of the test systems are described below.

All test systems essentially consist of three elements:

- measuring instruments,
- hardware integration,
- software and documentation.

The selection of the measuring instruments is dictated by the required **system applications and measurement standards**, whereas the total efficiency of the system is determined by the **intelligence**

of the measuring units, the ergonomics of hardware integration, the quality of system software and its documentation.

The well-proven **Mobile Tester SMFP 2** serves in both systems as the central measuring instrument for all usual transceiver tests. The system program is therefore considerably simplified and shortened because the SMFP 2 automatically performs a **multitude of complex test routines**. For the occasional manual measurement the SMFP 2 is ideal, especially in combination with the **Analog Display SMFS-B9**.

The **Test Receivers ESH 3** (9 kHz to 30 MHz) and **ESVP** (20 to 1300 MHz) perform selective measurements and, with the incorporated calibration facility and microprocessor-controlled test routines, measurement capabilities and precision of the highest standard are ensured (see **NEWS special 1** "Signal-strength and interference measurements"). The spectrum of applications ranges from twoport measurements with automatic frequency scan through to frequency-compensated measurements of spurious signals.

A further system component is the low-noise **Signal Generator SMPC**. This supplies, for example, test signals with 0.1-Hz resolution for SSB receivers, interfering signals for two-signal measurements on VHF and UHF transceivers in line with CEPT. It also functions as a local oscillator for the **Precision Sideband Mixer ATS-SM** or **Adjacent-channel Power Meter NKS** and as a signal source for the **Vector Analyzer ZPV**. Naturally, the SMPC also serves as a general-purpose signal source between 5 kHz and 1360 MHz.

The **Generator SPN** serves as a second AF source for SSB intermodulation measurements. Equally important are the peripheral units:

- **RF Relay Matrix PSU and Relay Matrix PSN** (AF and DC) for switching signal paths,
- programmable **Power Supplies NGPU 70/20**,
- **RF Step Attenuator DPSP** (0 to 139 dB, 1 W) and **High-power Attenuator RBU** (20 dB, 100 or 400 W),
- **Code Converter PCW** as TTL control-signal source,
- **Universal impact and Ink-jet Printers PUD 2/3** (graphics capability)

as well as an **IEC/IEEE-bus expander** providing for the isolated connection of further bus devices.

Hardware integration

In both systems the integration of the units into racks was conceived in accordance with customer stipulations and implemented from the points of view of ergonomics, measuring technique and safety. Units most frequently used are set at eye level, allowing optimal access especially for program writing and manual control. For reliable performance of two-signal measurements for example, all RF cables are **double-shielded** and made as short as possible. **Reproducible signal conditions** are ensured by fixing in cable ducts or through cable clamps.

All units and measuring-rack components are earthed in line with **VDE** (Federal-German Electrical Engineers Association) requirements. The AC power supply is applied to the system via **EMI filters**, thus preventing any external noise from affecting the test routines. An emergency switch quickly isolates all units with the exception of the **Process Controller PUC** from the AC power supply.

The test system for modules and final test is fitted with the universal system **Connection Panel ATS-SP** (FIG 4), offering all the connectors required for the adaptation of a test item:

- RF inputs/outputs 30 and 400 W,
- output of Signal Generator SMPC,
- input of Test Receiver ESVP,
- freely assignable RF and AF contacts,
- TTL control outputs of PCW,
- DC power supply,
- multipoint connector for AF, DC, relay and BCD control signals,

- **IEC/IEEE-bus connector** for hooking up additional measuring devices.

An **elapsed-time meter** helps keep track of calibration intervals and replacement/cleaning of air filters.

In the adaptation of the test item, the multipoint connector allows modules or complete transceivers to be connected up without producing a "jungle" of cables. For the adaptation of a typical transceiver including the digital control of the transceiver's control section, all that is needed are three cabled connections:

- RF input and output,
- multipoint connector,
- DC power supply.

The system can be retrofitted for mobile use by replacing the cabinet legs with shock-absorbing rubber runners. Shock absorbers are fitted between the rear of the cabinet and the shelter wall for protection against vibration and possible tilting in the direction of travel. A flexible duct through the enclosed top section of the rack conducts the warm air to the outside.

The system for acceptance tests does not require the versatility of the system connection panel; such facilities can be retrofitted however.

**Know-how + experience
= system software**

Apart from the adaptation of the test item, the two systems also differ in the software

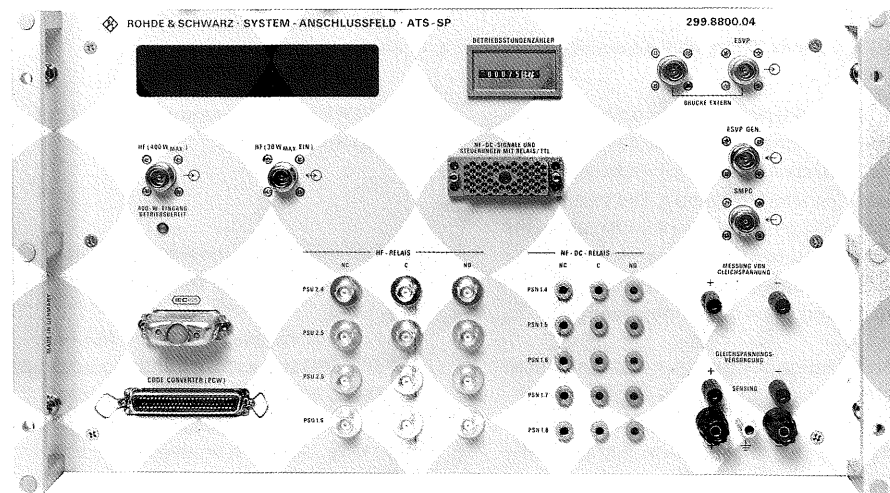

FIG 4 System Connection Panel ATS-SP for automatic test assembly for module and acceptance testing.

concept. The building-block structure of the system software is identical throughout. Whereas the laboratory test system for modules is required not only for complete transceiver tests but often for simple, one-shot test routines, ie general RF measurements such as vector analysis or selective twoport measurements, the acceptance test system finds application almost exclusively in long test runs on transceivers.

This explains why the laboratory test system is provided with four software packages with a view to optimal utilization of the test assembly:

AM, FM, ϕ M transceiver tests, SSB transceiver tests, impedance measurements, selective RF measurements.

The acceptance test system is only provided with the first two software packages. In order to maintain the same software structure for different hardware configurations and to make the software itself transparent, the **concept of modular basic software** is applied to Rohde & Schwarz test systems.

Why modular basic software?

A particular test module remains the same even when used for widely differing applications, eg testing modules in the laboratory in contrast to acceptance test in final units. The difference lies in the overlay structure that determines access to the test modules, in other words in the form in which the user software is created.

At the outset, the user edits the module in the required sequence, assigns measurement parameters and specifies data output. The construction of **menu-controlled user software** is only meaningful if the requirements regarding extent and flexibility are known exactly. Otherwise, the system of plausibility and control checks for the software management will be too complex, meaning that possible extensions to the user software for increasing measuring capability may only be accomplished by specialists. In the case of the acceptance test system the menu concept was devised for the **SSB software package**. The underlying principle, however, remains that of the modular basic software as shown in FIG 5.

By keeping the test-driver module and device-driver module separate, measuring

instruments for a particular function can, if required, be changed rapidly. In this case it is only a matter of replacing the device driver for the required function and instrument initialization (interface bus) in the basic software package. The technical know-how inherent in the test-driver module can therefore continually be used unchanged and need not be "re-invented" To simplify the test-system user's task

sis programs also via host computers connected to form LANs. Data thus obtained can be directly transferred to production robots in the "factory of the future" and used in final test programs.

Hans-Joachim Jonas

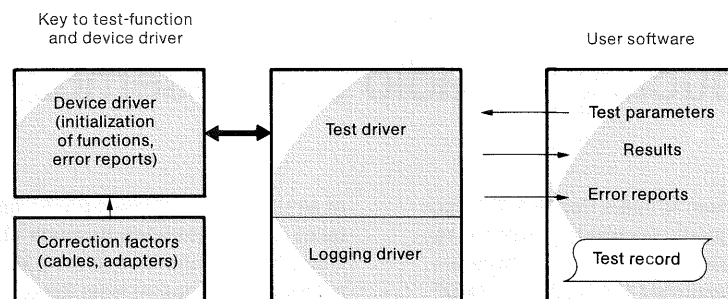

FIG 5 Block diagram of basic software concept.

when creating new device- and test-driver modules, the system controller must be configured optimally for this task. This is the case for the **Process Controllers PUC and PCA 5**, which are provided with an extended Basic especially for IEC/IEEE-bus commands. As the bus commands use virtually plain-text notation (eg IEC OUT for outputting on the bus or IEC DCL for IEC DEVICE CLEAR), it is simple to write an appropriate driver or to follow programs written by others.

The growing test system

With a view to exploiting all the capabilities of the test system, a complex field such as transceiver testing in the laboratory and during acceptance tests calls for engagement on the part of the user. Rohde & Schwarz supplied for both systems the necessary tools: **basic software packages, utilities for selftest and data management, system documentation and training**. Since technology is under continuous development, R & S is there to provide after-sales support.

The test systems described can be linked to a **central computer** for further processing of the measurement data. For the laboratory test system this represents the leadup to the "lab of the future", which will afford **more efficient and faster development** with the use of synthesis and analy-



interviews

Radio test assemblies from Rohde & Schwarz in everyday use and what their users think of them – those are the subjects of the thirteen interviews on the pages that follow. But first a look at the production of radio test assemblies at the R&S plant in Memmingen, Allgäu.

Production of radio test assemblies

For more than 15 years Rohde & Schwarz has been producing highly successful radio test assemblies. The earlier generations of equipment such as SMDA/SMDF and SMDU were followed by SMFP 2 and SMFS 2, several thousand of which have already been sold. The following description of the manufacturing process refers to these two types of equipment.

At all stages of equipment production mistakes can unfortunately be made when inserting components, soldering and assembling. Extensive tests during production help to eliminate these errors in good time. **Tight feedback** throughout production **minimizes** potential sources of error.

In R&S instrument production the insertion of components is automated to approx. 70%. During insertion the identity of the components on the banderole is checked on a sequencer. The finished printed circuit boards (PCBs) are subsequently passed on to **automatic testers** for preliminary checking.

Test philosophy

The first stage in the production of any electronic equipment is the testing of the chosen components, since there is a rule that the costs at the next production stage rise by a factor of 10. Therefore defective components must be detected as early as possible.



▲ **Wilfried Kalmus is a product-group manager and has been responsible for the manufacture of radio test assemblies and RF signal generators for more than 16 years.**

◀ **Final-inspection bay for Mobile Testers SMFP 2 and SMFS 2.**

Ways of testing PCBs

1. **Wiring tester** for checking all types of motherboards.
2. **In-circuit testing**. An in-circuit tester checks the functioning and tolerances of components already integrated into the circuit. This basic test takes approx. one to two minutes and ensures that a PCB is at least 90% free of errors.
3. **Digital performance test**. Digital PCBs are compared in performance to a sample PCB. Owing to this procedure programming and troubleshooting can be effected very rapidly.

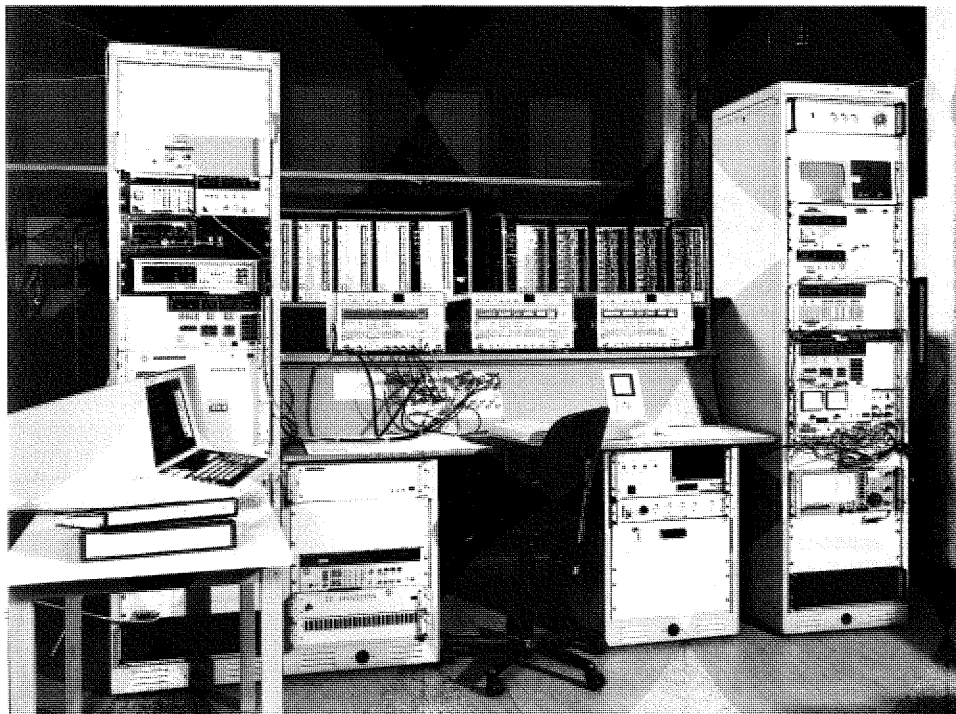

4. **Analog performance test.** The test assemblies required for analog performance testing are developed and produced by Rohde & Schwarz itself. In addition to test functions the programs include alignment instructions. This means that the interface specifications set for the PCBs must be aligned, checked and recorded. As a consequence, boards can be replaced later on during final inspection and servicing without any readjustment.

Final inspection

In the final stage mechanical parts and electronic boards are combined to produce radio test assemblies. By taking random samples **quality assurance** also checks the mechanical quality of the finished equipment.

The entire testing procedure is laid down in the test sequence plan shown here. **R&S works standards** prescribe trimming instructions (HVB 400) and a test report (HVB 410) in addition to this test sequence (HVB 405).

Trimming instructions are necessary to optimize product quality and minimize production costs. They are also the basis for preparing test reports and extracts are included in manuals to assist servicing.

For keeping records of the final inspection of modules, devices and systems test reports must be drawn up. As a matter of principle, the rated values and tolerances measured during final inspection have to meet the specifications given in the respective data sheets (sales literature). The rules for testing on automatic equipment and for manual testing are more or less the same. Test reports are placed at the disposal of customers at their request.

Below the individual inspection stages are described in greater detail.

- **Turn-on test:** computer-controlled performance test ensuring that all functions are operative.
- **Burn-in test:** during this one-week test line-voltage values and temperatures are cycled through in the test chamber at +45°C in order to provoke, detect and eliminate early failures.

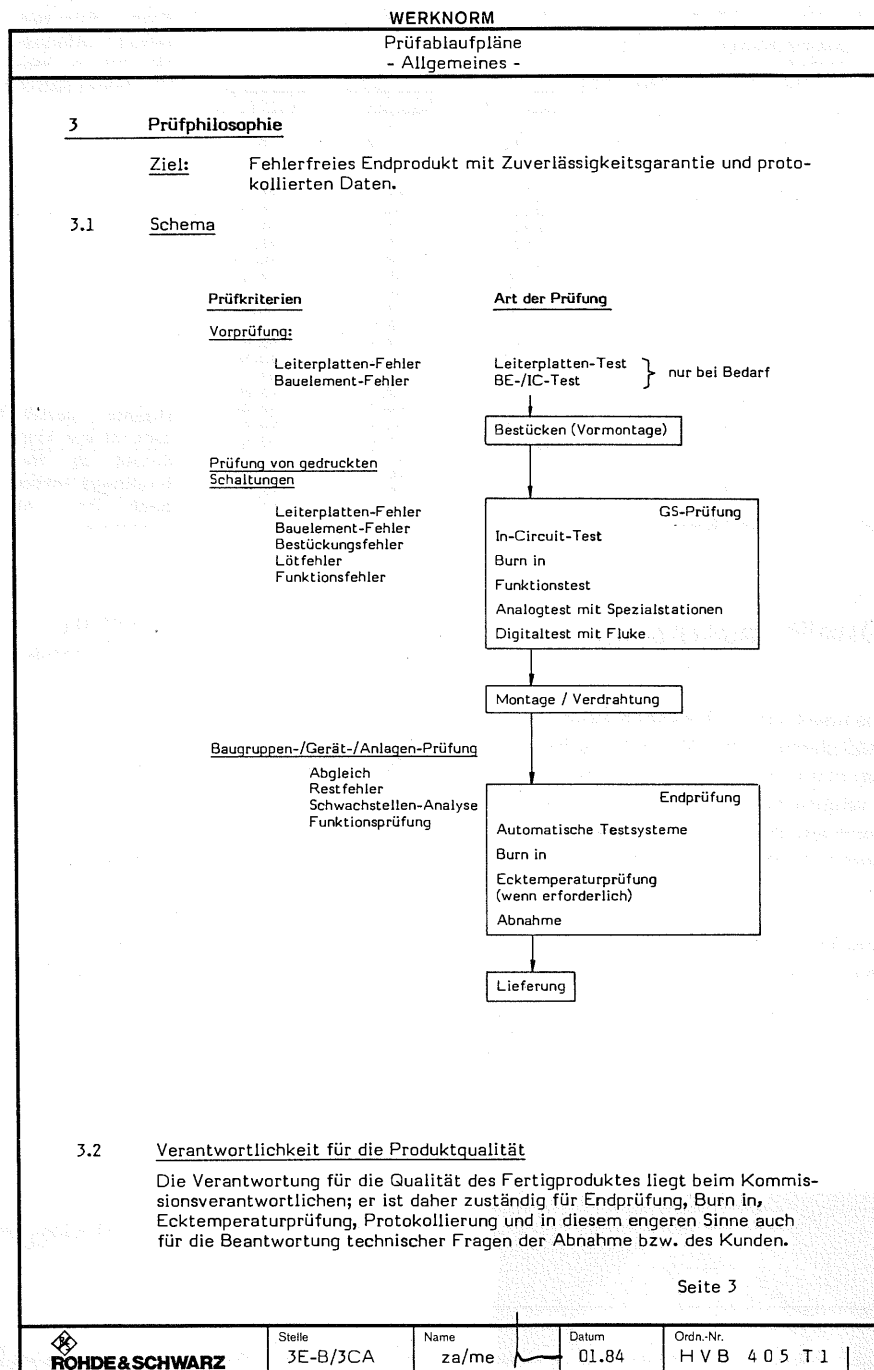

Test sequence plan acc. to R&S works standard HVB 405.

- **Generator alignment:** computer-controlled alignment and testing on the basis of more stringent specifications.
- **Receiver alignment:** semi-automatic testing and alignment on the basis of more stringent specifications.
- **Signal-purity check:** harmonics and spurious responses are automatically checked overnight on twelve SMFP 2/ SMFS 2.
- **Test I** is finished and set down in a report after these test cycles.
- **Reliability test:** test assemblies must prove their reliability in one week of continuous operation.
- **Test II:** the final or sales inspection ensures the outgoing quality. The final inspection report that serves as proof of quality is kept on file for up to three years.

DAEMPfungSTEST +13...-125dBm

F = 27.14MHz, REF. = 13dBm, INT. TOL.

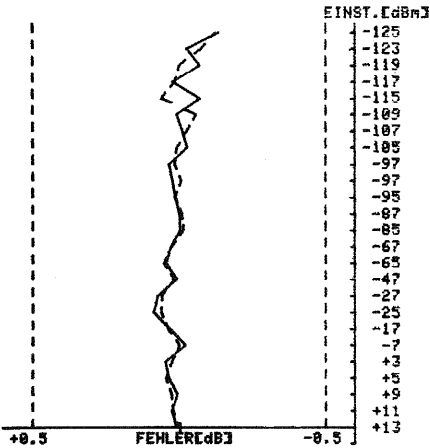

RF-OFF > 139dB I.O.

FEHLER [dB] MESSUNG I	FEHLER [dB] MESSUNG II
-0.13	-0.12
-0.03	-0.07
-0.07	0.00
+0.03	+0.02
-0.07	+0.06
+0.01	-0.06
-0.01	-0.02
-0.03	+0.01
+0.04	+0.02
+0.02	-0.01
+0.01	+0.02
0.00	-0.01
0.00	-0.01
+0.03	+0.03
+0.05	+0.05
+0.01	+0.02
+0.07	+0.06
+0.09	+0.06
+0.03	+0.04
-0.02	0.00
+0.05	+0.03
+0.04	+0.05
+0.01	+0.03
+0.03	+0.02
+0.01	0.00

Extract from test report: attenuation test on Mobile Tester SMFS 2.

QUALITÄTS ZERTIFIKAT

Sehr geehrter Kunde,
 Sie erhalten heute ein nach modernsten Qualitätssicherungsmethoden gefertigtes Rohde & Schwarz-Gerät. Es wurde in meiner Verantwortung endgeprüft.
 Sollten Sie trotzdem bei **Ersinbetriebnahme** Anläß zu einer Beanstandung haben, bitte ich Sie, die anhängende Karte ausgefüllt zurückzusenden und dem nächstliegenden R&S-Service mit der Reparatur des Gerätes zu beauftragen.
 Danke für Ihre Information!



MEK Meyer J.

Zustellen/zu empfangen:	BEANSTANDUNGEN	SHORTCOMINGS	Please tick off as reported
	Beschädigte Verpackung	<input type="checkbox"/> Packing damaged	
	Mechanische Mängel	<input type="checkbox"/> Mechanical faults	
	Elektrische Mängel	<input type="checkbox"/> Electrical faults	
	Vermutlich Transportschaden	<input type="checkbox"/> Damage probably due to transport	
	Zubehör unvollständig/fehlt	<input type="checkbox"/> Accessories not complete/missing	

Reparatur durch R&S-Service: Repair by R&S service center:

Weitere Informationen: Further information:

Datum/Date: Name: Unterschrift/Signature:

Firma/Company: Land/Country:

Adresse/Address:

Quality certificate of the kind issued by the final inspector for each item of equipment.

Quality assurance

The **quality analysis** of serial equipment (R&S standard QVP 050) is an additional way of ensuring quality. This is carried out at irregular intervals by quality assurance, which also determines the types of equipment to be inspected and the date of inspection.

According to the test sequence everything from the simulation of transport and packing conditions to the completeness

of accessories must be checked. The focus in quality analysis is on determining quality during operation.

Quality certificate

The final inspector makes out a quality certificate for each item of equipment tested. This certificate is the "formal connection" between production and the user. The certificate and the attached "Shortcomings" card furthermore ensure

that any defect detected by the customer on receipt of the equipment is immediately reported to the production plant, so that measures can be taken to improve quality in the future.

The system applied by Rohde & Schwarz for quality assurance is **approved by government authorities and civil organizations.**

Wilfried Kalmus



Hans Sulger, telecommunications engineer and senior project manager at Autophon in Solothurn.

At Autophon in Solothurn systems come out customized

Simulating complex radio systems

Switzerland's **Autophon AG** has acquired a solid reputation worldwide as a **communications specialist** since the company was established in 1922. The 15 employees of those early days are now 3500 in number and the product range includes units and systems from major areas of communication like voice, music, data and image transmission by wire and radio plus data-display and paging systems, pneumatic dispatch, cable and antenna installations. The company headquarters, development, production and central administration are based in **Solothurn**.

Autophon produces **radio sets** for the 4-m, 2-m and 70-cm bands, and of late also for 900 MHz. Then there are **car telephones** for the Swiss **NATEL** network. "Our real strength lies in **radio systems**", explained telecommunications engineer **Hans Sulger**, senior project manager at Autophon, "these are **tailored to users' special requirements**".

Such radio systems are **microprocessor-controlled** and the **control functions** can be **very complex**; thoroughly simulating these systems and maintaining them is

no easy job. "We looked for suitable radio test assemblies for a long time and then came across those from Rohde & Schwarz. Using them we can test our radio systems extremely fast and, above all, in a **reproducible** fashion". Mobile Testers SMFP 2 and Signal Generators like SMS and SMPD are consequently much in evidence at Autophon.

The **foundation for the measuring routines** was the **basic software** from R&S, which was adapted in parts to the special requirements at Autophon. Thus it was necessary, for instance, to perform a **deviation measurement reliably in just 300 ms**.

As an absolute novelty Autophon recently sold a radio system complete with an SMFP 2: "The customer is quite enthusiastic and considers it an enormous advantage. In future we'll continue to sell testers like this as an **integral part of our systems**".

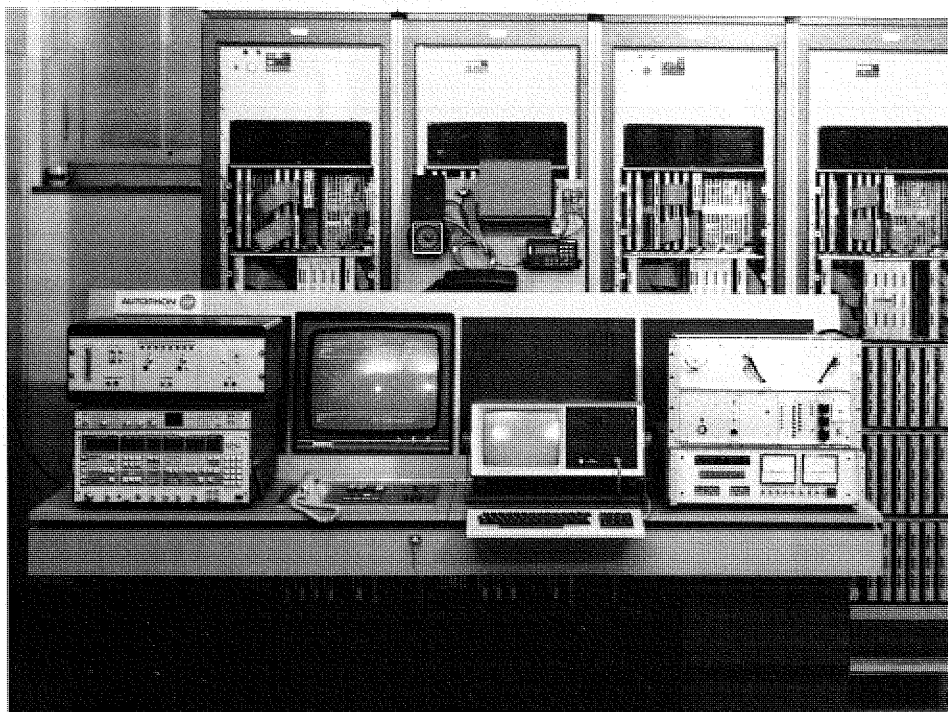

Computer-controlled radio centre as an example of the radio systems that Autophon develops and produces tailored to user requirements.

BBC markets radio sets worldwide from Kappelerhof in Baden Professional sets for professional customers

The worldwide concern **Brown, Boveri & Cie** (BBC) has been involved in radiocommunications since the 1930s – long enough to acquire a wealth of know-how. Its information and communications group nevertheless represents a relatively small part of the activities that have made BBC's worldwide reputation: generation, distribution and application of energy.

The communications division supplies large-scale communication systems to all parts of the world. Radiocommunication engineering and sales are based in **Turgi**, as are production and testing facilities.

The sales centre for radiocoms products, ie essentially mass sales by way of appointed dealers, is the **Kappelerhof** near **Baden**. From here Swiss dealers are supplied and importers in neighbouring countries. Among these products the **RT-41 series of mobile radios** is particularly successful and the concern is also



Claude E. Petignat, Swiss sales manager for BBC's radio sets and systems.

strongly engaged in Switzerland's **NATEL** car-telephone system: "BBC supplied all fixed stations for this and in mobile telephones we hold a market share of 50%", explained **Claude E. Petignat**, Swiss sales manager for radio sets and systems.

So that customers can be offered a wide range of radio equipment of all kinds, various special items of equipment are purchased and resold. **Personal radios for the 934-MHz band** were a success right from the start. "Switzerland was the first European country to offer this service. We adopted the Japanese system right away. Our unit has 40 channels: 39 for voice and one data channel. In the bands 4 m, 2 m and 70 cm our customers are entirely professional. With personal radio we also want to draw customers who can use the units professionally at an attractive price. The possibility of implementing extensive selective-calling programs by data telegrams means that you have to

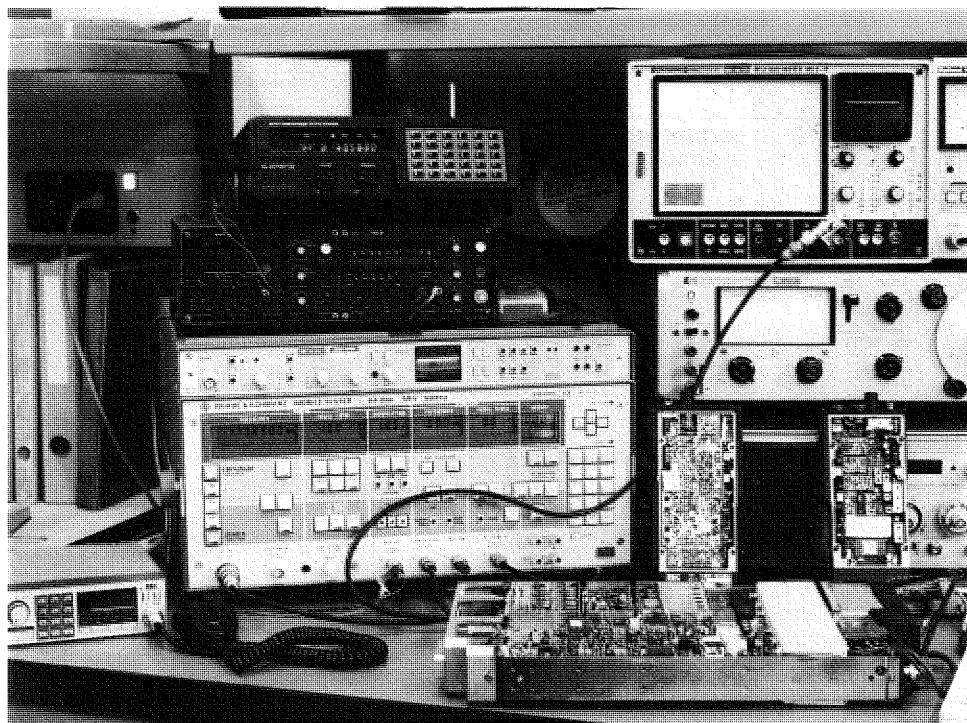

BBC is strong on the NATEL market and in personal radio (unit to the left of Mobile Tester SMFP 2).

get into **Hagelbarger code** when servicing – a typical case for Rohde & Schwarz's Radiocode Test Set SCUD. The radio sets themselves are thoroughly checked out by a Mobile Tester SMFP 2.

Of course we need **optimal measuring instrumentation** because of the diversity of our radio equipment. We do all we can to ensure that our technicians are able to work rationally and efficiently. I'm convinced of the worth of R&S's instrumentation".

The data telegrams of personal radios do not tax an SCUD to the full of course. At BBC it is mainly used to check the many kinds of signalling involved with NATEL units. Anyone, like BBC, installing all the fixed stations of such a network needs really unassailable measuring gear.

In Dübendorf Ericsson runs a comprehensive technical service Customized adaptation and speedy service

In the field of telecommunications Sweden's **Ericsson** ranks among the biggest concerns. Its product range is correspondingly large and varied: screen terminals, printers, radio sets, personal computers, paging systems, typewriters, intercom systems and lots more. In **Dübendorf** in Switzerland Ericsson has its central technical service, offering adaptation, maintenance and repair for the entire spectrum of equipment.

The wireless side of business, ie **radio sets and paging systems**, is mainly in the hands of **Arnold Stingel**. "Our products come to us from Sweden. For the Swiss market many an adaptation has to be devised, and that's what we do here. Servicing is also carried out from here, we don't send anything back to Sweden".

For what are often very different kinds of work Stingel uses instrumentation from

Rohde & Schwarz: Mobile Testers SMFP and SMFS 2 as an "individual" test assembly, Radiocode Test Set SCUD, Process Controller PPC. To make sure there are no ambiguities in the values measured, all test assemblies are linked to an **R&S frequency standard** (XSD 2 with XKE 2, XSRM-Z, XKE 2-Z1), which functions more or less as the central "pacemaker".

"Before we procured the R&S test assemblies we looked around at shows and exhibitions for a computer-controlled system – who made this sort of system and what the software situation was like. And we arrived at the conclusion that Rohde & Schwarz offers the most. We received the **basic software** and modified it somewhat, and thus we didn't have to

Arnold Stingel, technical manager for radio-communications at Ericsson in Dübendorf near Zürich.



start from scratch. Software today is a big cost factor and there's little sense in inventing the wheel a second time, so to speak".

Ericsson is particularly successful with its μ P-controlled C-600 mobile radio. The available frequencies and channels plus selective-calling codes are stored in a PROM, so the characteristics of these units are defined purely digitally. "The SCUD was purchased so that we had a selective-call measuring apparatus which can do everything we couldn't do before". Errors in selective calling now become clear straight away.

Ericsson conducts 100% **outgoing inspection**. The technicians who repair the units measure with the same test assembly (SMFS) as in the computer-controlled facility (SMFP) and work with the same routines. "In the R&S test assemblies there are a lot of things that run automatically and thus take some of the workload off our shoulders. We're well satisfied with them".

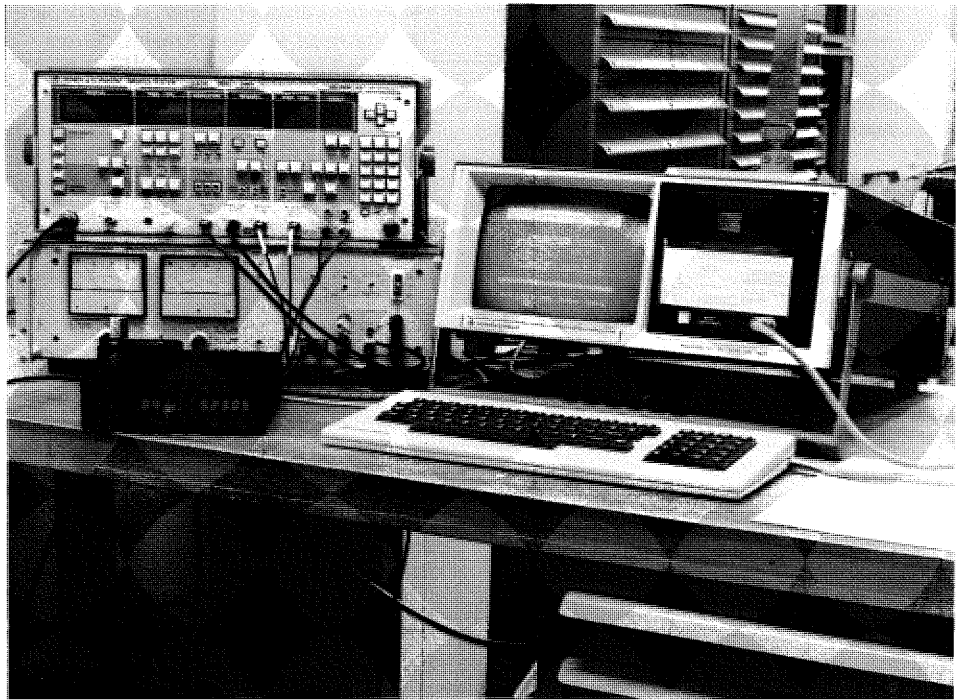

A C-600 mobile radio with μ P control being put through its paces by SMFP and SCUD.

ESG in Linz/Danube: energy supply, district heating and transport utilities Radiocommunications in service to the public

Things like reliability, safety and operational readiness take on special significance when they are spoken of in connection with an **energy-supply and transport utility like ESG in Linz/Danube**. Here communication is an indispensable aid, whether it be **computer communication over microwave links** for controlling transformer stations and load distribution or a **radio set in a tram or bus**. As is only sensible in such a large undertaking, all radio devices are maintained and repaired in ESG's **own workshops**, and the demands made of the measuring instrumentation are in direct relation to the **high level of responsibility** attached to them.

Engineer **Johann Reisinger**, who is chiefly responsible for radio operations within ESG, explained his work as follows: "Everything that has to do with radio is planned, acquired, installed and maintained in and by this department. We have

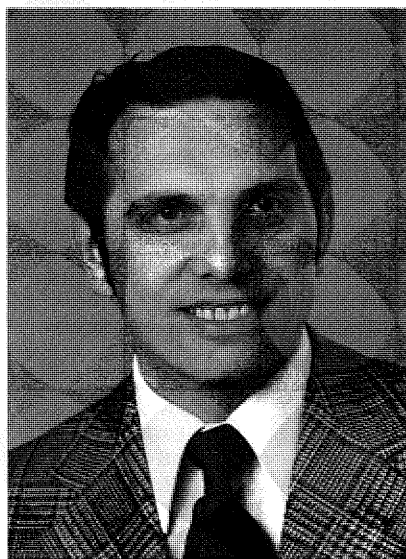

At ESG in Linz/Danube engineer **Johann Reisinger** is chiefly responsible for radio operations.

about **500 mobile radios** in use and numerous repeater stations; the operating frequencies go from the **4-meter band** up into the **1.5-GHz region**".

The range of equipment that has to be serviced is correspondingly diverse: mobile and handheld radios, paging and secondary-paging receivers, microwave links and repeater stations in the way of fixed installations.

With variety and range like this the radio group can hardly complain about lack of work, and its tools of the trade from Rohde & Schwarz are fully up to the mark: a Radiotelephone Test Assembly SMDA for servicing 2-m and 4-m units, a Mobile Tester SMFP plus Radiocode Test Set SCUD, Printer PUD and RF Relay Matrix PSU.

These are all managed by Process Controller PPC over an **IEC/IEEE bus**, and when

the SCUD is not working with the SMFP it monitors, by way of a VHF-UHF Receiver ESM 500, the call-tone sequences of ongoing radiocommunications as a sort of control instance. "The SCUD saves us an

enormous amount of time", stated departmental head, engineer Kmenta. "Errors that we wouldn't otherwise be able to locate are detected very simply by the SCUD".

Log of a battery test (NiCd battery of a handheld radiophone) produced with URE, PPC, PUD and a specially devised interface.

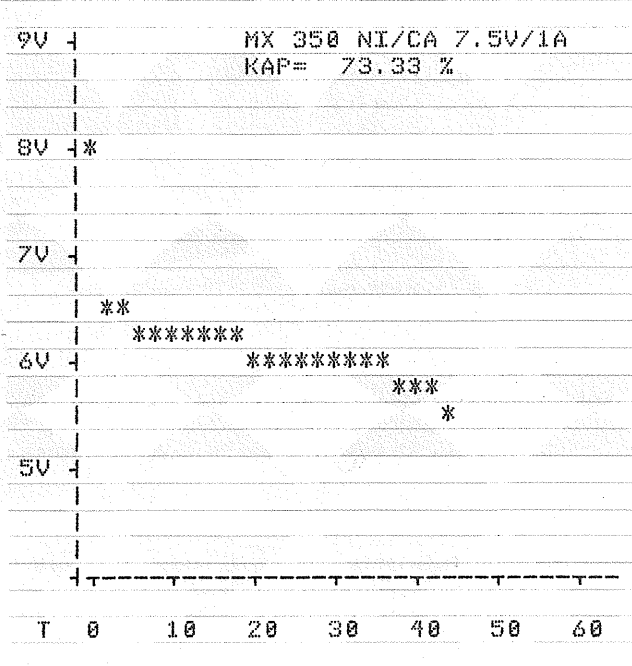

A view of part of ESG's radio repair facilities.

When a radio set arrives for repair, it is first put through its paces on the automatic tester (SMFP). "For simple tests we also have another assembly. But when we're looking for accuracy we use the SMFP". The software is composed of the standard R&S software and software specially written for the equipment concerned. SCUD uses the special R&S software SCUD-K1.

After its repair a set passes to final inspection, again on the automatic tester. The measured values are logged and also stored as statistics on floppy disks: "Thus we know precisely what errors occur in what equipment in the course of a year and very often we can then undertake preventive measures".

There is consequently lots for the instrumentation to do in an energy-supply and transport utility like ESG: "All our radio sets are in use for a high proportion of time and the conditions involved in energy supply can be very rough. The sets are exposed to high temperatures when our vehicles are standing in the sun, or the abrasion produced by trams causes metallic dust to be deposited in them, and so on". For field service, ie on microwave links and repeater stations too, ESG also takes along the compact and easy-to-use R&S Wattmeters NAU and NAUS when it comes to determining whether transmitters are producing the necessary RF power and how well an antenna is working (reflection, etc). For the growing tasks facing them in future ESG's radio technicians are looking to, among other things, the new Power Reflection Meter NAP so that they can fulfil their complex duties even faster and with greater precision.

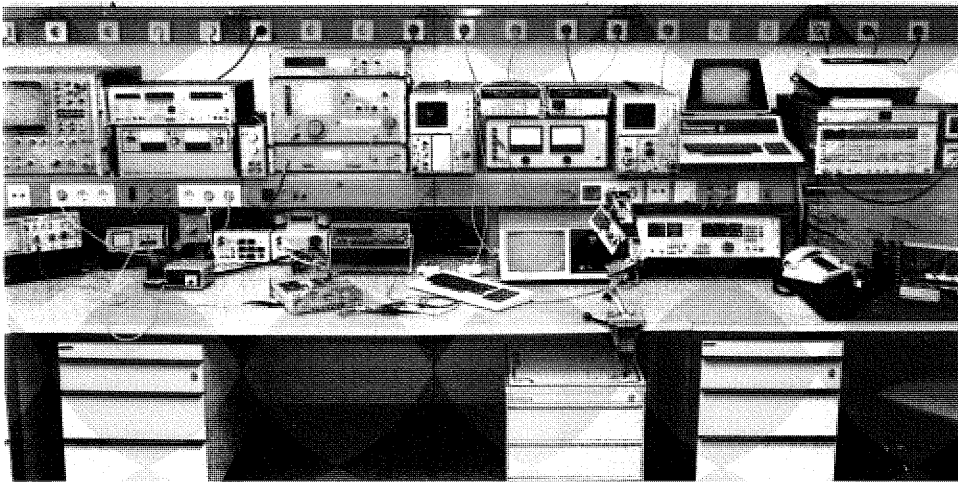

Log of transmitter and receiver data of a radio set, produced by SMFP, PPC and PUD.

ESG FT		TV 70 B		729712	
SENDER		EMFAENGER			
LEISTUNG (W)	5.34	SINAD (UV)	.318		
ABLAGE (HZ)	-160	ABLAGE (KHZ)	-.1		
STOERHUB (HZ)	.01	BANDBR. (KHZ)	13.2		
MOD. EMPF. (MV)	7	NF-HOERER (MV)	293.9		
KLIRRF. (%)	4.59	KLIRRF. (%)	3.19		
MAX. +HUB (KHZ)	2.36	SQUELCH + (UV)	.23 / .28		
MAX. -HUB (KHZ)	2.36	SQUELCH H (DB)	1.7		
NOTR.FR. (HZ)	2798	RUF AUSWERTUNG			
NOTR.HUB (KHZ)	3.44	U BATT	23.39		
NO-TX/RX (SEC)	10.6 / 6.7	STROM TX/RX	1.41 / .24		

A mecca of CB and personal radio: Jacob Trading in Othmarsingen

In-house testing guarantees the lead

Anyone interested in CB radio or, since of late, personal radio or simply looking for antennas, microphones, multirange receivers or VSWR bridges will find the right address in **Othmarsingen** in Switzerland: **Jacob Trading International**. The small company celebrated its tenth birthday in 1985 and has grown quite exceptionally during the relatively short period. It is well supported by a number of instruments from Rohde & Schwarz: two Mobile Testers SMFP and two SMFS 2 (plus analog display option), two Process Controllers PPC, a Radiocode Test Set SCUD, a Power Reflection Meter NAP and a Printer PUD 2.

At Jacob they are particularly proud of their own five **type-approved CB sets** series Mark I through Mark III, PC 404 and PC 1010, which in addition to AM and FM are also in part equipped for SSB (USB and LSB). "For SSB tests we take the SMFP and use a little trick", company owner **Ernst Jacob** told us. "We offset the receiver upwards by 1 kHz and thus obtain the difference between the two frequencies we're measuring. We do it on the transmitter too - we can measure modulation frequency response for SSB". For

this application R&S's **basic software** was slightly modified. More than 10,000 radio sets have been tested in this manner alone during the last two years.



Big in CB and personal radio: Ernst Jacob, owner of Jacob Trading International in Othmarsingen.



▲ **The type tests on Jacob's own five CB models are performed on these setups.**

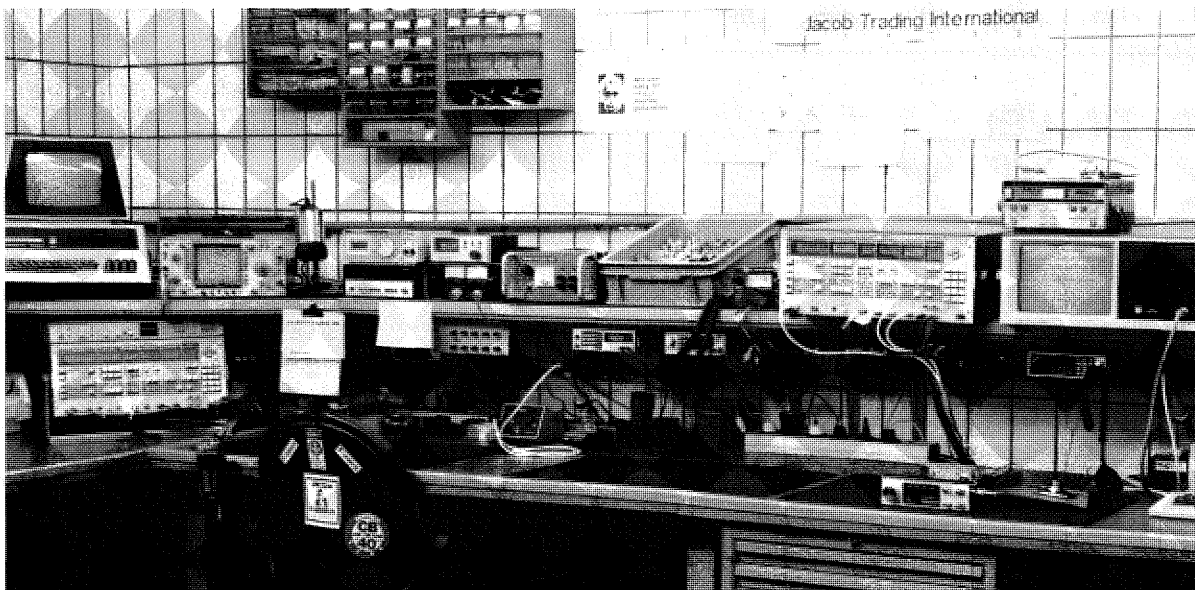

◀ **SMFS 2 (with analog display), SCUD and NAP form the nucleus of the personal-radio test assembly for 934 MHz.**

MESSPROTOKOLL SPRECHFUNKTEST

SENDERTEST		FM	AM	USB	LSB
KANALFREQUENZ	(MHZ)	27.085	27.085	27.086	27.084
SENDELEISTUNG (99.9 PEEK)	(W)	.5	.5	.78	.78
BEMESSENE FREQUENZ	(MHZ)	27.08505	27.08503	27.086	27.084
FREQUENZ-FEHLER	(HZ)	45	25	30	-10
NACHSARAKANALLEISTUNG	(UM)	5.74	0	0	0
MIKR.-EMPFINDLICHKEIT	(MV)	1	3.3	.5	.5
POS. MODULATION	(KHZ/%)	1.41	57.09	0	0
NEG. MODULATION	(KHZ/%)	1.38	57.19	0	0
POS. MOD.-BEGRENZUNG	(KHZ/%)	2.59	90.79	0	0
NEG. MOD.-BEGRENZUNG	(KHZ/%)	2.56	89.09	0	0
KLIRRFAKTOR @ 300 HZ	(%)	3.79	1.5	0	0
KLIRRFAKTOR @ 1 KHZ	(%)	2.19	.79	0	0
SENDER-S/N	(DB)	34.3	51.5	0	0
MODULATIONSFREQUENZGANG					
.4 KHZ	(DB)	-7.6	-7.6	-4.8	-6.5
.5 KHZ	(DB)	-5.3	-5.1	-2.5	-4.2
.6 KHZ	(DB)	-3.4	-3.3	-1.4	-2.6
.7 KHZ	(DB)	-2.5	-2.1	-.9	-1.4
1 KHZ	(DB)	0	0	-.1	-.1
1.25 KHZ	(DB)	1.1	.6	.3	.2
1.5 KHZ	(DB)	1.9	.8	.5	.3
2 KHZ	(DB)	2.6	.5	.4	.2
2.3 KHZ	(DB)	.9	0	0	-.3
2.5 KHZ	(DB)	-1.3	-.3	0	-.8
3 KHZ	(DB)	-7.5	-1.4	.2	-1.1
EMPFÄNGERTEST					
KANALFREQUENZ	(MHZ)	27.085	27.085	27.086	27.084
S/N @ 1 MV HF	(DB)	36.3	36.5	0	0
SINAD @ 1 UV HF	(DB)	20.3	21.7	18.5	26
EMPFINDL. F. 10-DB-SINAD	(UV)	0	0	.165	.125
EMPFINDL. F. 20-DB-SINAD	(UV)	.782	0	0	0
EMPFINDL. F. 10-DB-S/N	(UV)	0	.337	0	0
KLIRRFAKTOR @ 1 KHZ	(%)	5.5	5.09	11.5	4.29
SQUELCH: HYSTERESE	(DB)	.4	0	0	0
SQUELCH: OBERE SCHWELLE	(UV)	.88	0	0	0
SQUELCH: UNTERE SCHWELLE	(UV)	.84	0	0	0
NF-FREQUENZGANG					
.3 KHZ	(DB)	-20	-18.3	-22.8	-17
.4 KHZ	(DB)	-11.5	-11.1	-13.2	-9.7
.5 KHZ	(DB)	-6.3	-7.1	-7.5	-5.3
.7 KHZ	(DB)	-1.6	-2.8	-2.1	-1.4
1 KHZ	(DB)	-.1	-.1	0	0
1.25 KHZ	(DB)	-.1	-.9	-.2	-.1
1.5 KHZ	(DB)	-3.1	-3.1	-1.9	-2.4
2 KHZ	(DB)	-8.7	-9.7	-5.9	-6.5
2.3 KHZ	(DB)	-11.8	-16.6	-7.9	-8.5
2.5 KHZ	(DB)	-13.6	-21.7	-9.1	-9.6
3 KHZ	(DB)	-17.4	-25.7	-11	-11.3

Typical test report for a radio set, here the Mark III.

Jacob is also very much engaged in the new personal radio in the UHF band 934 MHz. The SCUD is used to make the complicated signalling of the data telegrams in Hagelbarger code transparent. The market is flourishing and there is a lot to do: "Sooner or later we'll be needing another SCUD". The SCUD is additionally used for selective-call signalling (five-tone sequence, etc).

Where there are special needs for software, Rohde & Schwarz offers the assistance of its specialists. "The Hagelbarger code that's used in UHF units goes a long way into machine language and we don't have time to get down properly to problems of this kind. R&S's people have helped us here with their experience and we were glad that we could use the prepared software after slight modifications".

At Jacob they are very satisfied with their R&S instrumentation: "You always measure the same, whether it's Monday morning or Friday afternoon. And with a little technical understanding anyone can work the instruments. For satisfying the testing requirements stipulated by the PTT there's no better-value solution than an R&S measuring setup". Jacob looks ahead to coming equipment generations with every confidence: "We're well equipped and ready to take on anything".

Radio-set maintenance by the thousands at the KMV in Bern

Test system proven under rough conditions

If you operate handheld radios in their ten thousands and have to keep a few thousand onboard radio installations operational, you naturally need reliable measuring aids for their maintenance. At the KMV in Bern, the ordnance administration of the Swiss military department, the highest demands in all of Europe are made of radio equipment and measuring instrumentation, meaning that any radio testing equipment which is introduced must be absolutely faultless and flawless - even at -25°C.

All kinds of Rohde & Schwarz radio test equipment can be found in use with the KMV: SMDHs procured 15 years ago, SMDUs and SMPUs, SMFPs and of late also SMFP 2 and SMFS 2. With the newer equipment Process Controllers PUC are also employed. "The situation here is like this: when an item of equipment is introduced, it generally has to do reliable serv-

Dr. sc. techn. Jürg Wettstein, departmental head at KMV in Bern, bears overall responsibility for electronics.



ice for between ten and 20 years", is how Dr. sc. techn. **Jürg Wettstein** put it, who is a departmental head at the KMV. He is responsible for the maintenance of electronic material and radar installations in the Swiss army. "The operational reliability of the new SMFP 2 and SMFS 2 is particularly good". Which is no wonder, because before acquiring them Dr. Wettstein's engineers conducted **extensive trials in rough environmental conditions**. The verification of the radio test sets by Dr. Wettstein started up when the development phase of the equipment had barely ended. In other words, before market introduction the Mobile Testers SMFP 2 and SMFS 2 had already been thoroughly put through their paces for a period of one and a half years and approved for use.

"Procuring the R&S testers has proved very worthwhile for us", continued Dr. Wettstein. "The manual testing of a handheld radio used to take us more than half an hour, but now we only need one and a half minutes. And for onboard radio installations, what the SMFP and PUC can now do in 15 minutes used to be a job lasting an hour. We're naturally very pleased with these new test setups".

There is a special advantage in the fact that an **onboard radio installation** can be left in the vehicle for testing and no longer has to be removed, as used to be the case. A **custom application** has been created, fairly revolutionary in form, made up of the following functional units:

1. a mobile test system with the Mobile Tester SMFP as its nucleus, a Process Controller PUC, an adapter and a printer for hardcopy results;
2. a portable measuring equipment, con-

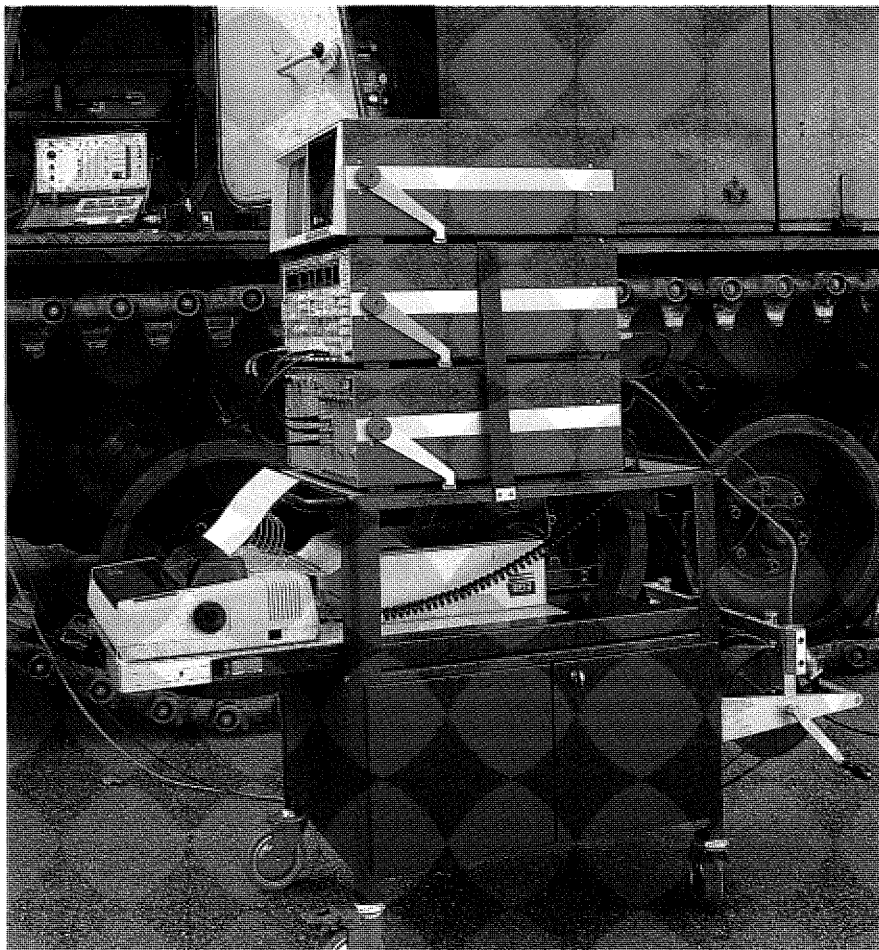

Mobile radio-set testing system with Mobile Tester SMFP and Process Controller PUC from Rohde & Schwarz plus adapter and printer. The portable measuring equipment with the control unit and RF measuring head is placed in the vehicle next to the radio installation that is to be tested.

sisting of a control unit and a measuring head for RF power and reflection.

The portable measuring equipment is placed in the vehicle next to the radio installation that is to be tested, while the

mobile test system can be left standing up to 50 m away. Depending on the type of vehicle concerned, the portable measuring equipment can be set up in 3 to 5 min. Defective radio equipment can subsequently be dismantled and repaired on an SMFS 2. A **final inspection** is made after the equipment has been reinstalled.

"With these testers we have managed to achieve a clear improvement in the quality of our radio apparatus. In the first tests using the equipment we had 30 to 40% faults on our radios. This was because our engineers and technicians **judged the values differently in earlier measurements**. But now we have **uniform and exact series of measurements**". Switzerland insists on reliability and precision – not only in its watches.

The control unit of the portable measuring equipment as a means of communication between the operator and the test system.

Photos: Martin Bani (2)

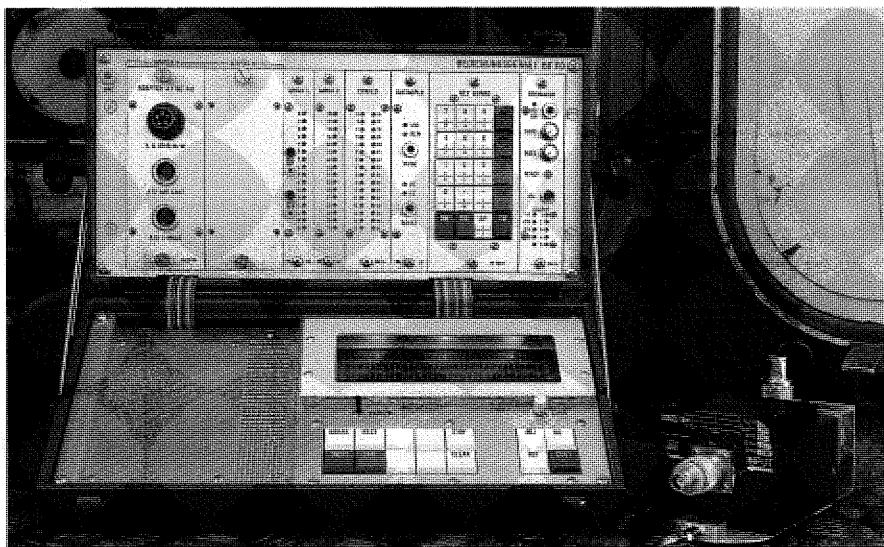



Hannu Ansio is the test manager of Nordic Division at Mobira Oy in Salo, Finland.

The Finnish Mobira Oy company is one of Scandinavia's major designers and manufacturers of radio equipment, a wide range of products coming from its four plants Aankoski, Espoo, Oulu and Salo, such as radiophones of different kinds, transceivers, personal-paging receivers plus all the associated stationary fixtures and base stations. The customers for this equipment are private persons, small businesses like taxi operators, corporations responsible for running public transport and on up to companies or administrations requiring complete, turnkey projects.

In the town of Salo, about one and a half hours by car from Helsinki, personal-paging receivers and mobile phones for cellular networks like AMPS, NMT and TACS are developed and manufactured. At this plant Hannu Ansio is the test manager and responsible for the procurement and installation of automatic test equipment in the production area. He adapted in good time to the big worldwide demand for cellular mobiles by looking for an instrument supplier whose measuring systems were up to the high standards called for in the development, production and quality assurance of such complex radiophones. In the early summer of 1984 Rohde & Schwarz was able to present a very flexible system composed of Radiocode Test Set SCUD, Mobile Tester SMFP 2, Programmable Power Supply NGPU plus ready software for thoroughly checking out mobile phones for cellular-radio networks.

With this system it is possible to run complete tests either under manual control or managed over an IEC bus, and it can be

High quality from Mobira in Europe's north Of AMPS, NMT, TACS and Co.

matched to production requirements in a Listener/Talker mode. The measuring accuracy, the speed and especially the reliability of the system were decisive factors where Ansio was concerned: "Sometimes our tests run round the clock, six days a week. We've no room for downtime in a schedule like that".

If the worst should come to the worst however, assistance is available and very close. The R&S representative Orbis Oy has its offices and instrumentation service in nearby Helsinki. This is a comforting thought for the test manager because he and his team are responsible for running and maintaining the testing facilities that will ensure a high-grade end-product. In the final part of this process all radio sets

go through temperature chambers, where they are tested under extreme climatic conditions and checked for adherence to specification. This takes some time but it can be managed fully automatically.

The problem of software for the signalling measurement routines that are called for – a very complex matter because of the complicated procedures in the different cellular-radio networks – has largely been solved in R&S's software packages for AMPS, NMT and TACS. Thus the team has been able to concentrate on the main task, that of integrating the AMPS, NMT and TACS test systems into the manufacturing environment.

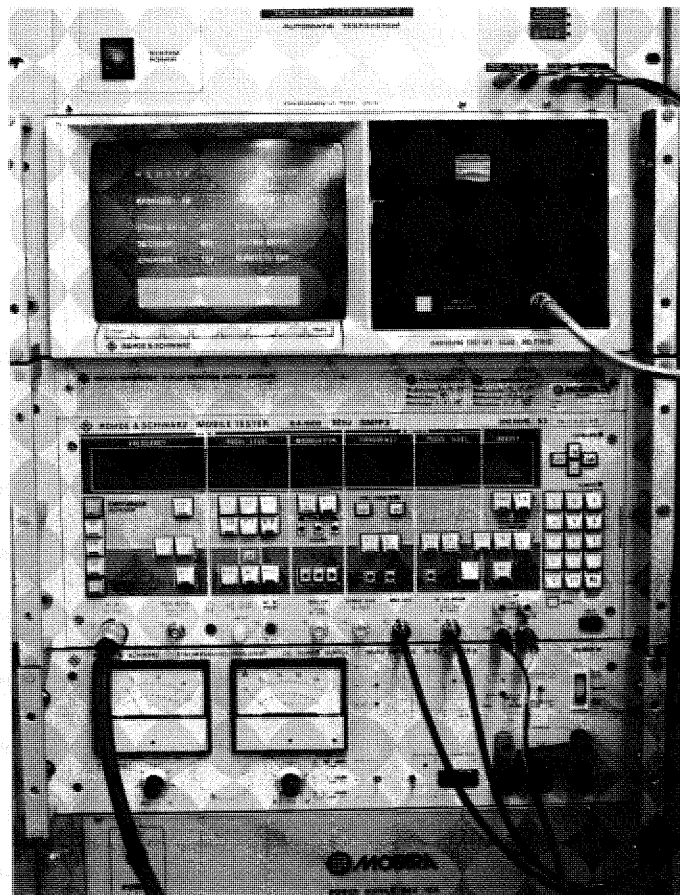

Rohde & Schwarz system for testing cellular-radio mobiles as used on the production lines at Mobira Oy.

From pager to fixed station: Motorola in Taunusstein

World fame starts in development

As a producer of electronic equipment, systems and components **Motorola** is now one of the hundred biggest industrial undertakings in the USA. The company employs some 90,000 people at production plants in 16 countries and in sales organizations in 110 countries.

In the area of radio sets and systems Motorola has won itself a high reputation worldwide. In **Taunusstein**, not far from Wiesbaden, mobile radios, fixed stations, handheld radiophones, signalling and alarm receivers, mobile and portable radio-data sets plus complex systems have been developed for more than ten years now. **Klaus Pai**, Dipl.-Ing., of product development works with SMFP and SMFP 2 Mobile Testers from Rohde & Schwarz: "These test assemblies can do just about everything that's required in radiotelephone measurements. We use them, for instance, to measure the sensitivity, selectivity, large-signal rejection, modulation

characteristics, output power, adjacent-channel power and frequency stability of radio sets of every kind according to the **prescribed measuring procedures of the different postal authorities**. We've also written some programs for routines that serve for testing synthesizers, VCOs and squelch circuits during their development".

For measuring the adjacent-channel power of radio sets intended for Britain and France, which work on a **channel grid of 12.5 kHz**, Pai additionally uses R&S Signal Generators SMPC: "We've had very good results using the SMPC. With its low sideband noise the measuring limit here is at about **90 dB**, and that really is good".

Instrumentation is controlled by a computer over an **IEC/IEEE bus**. "A very interesting application of the SMFP for instance is the **direct control of synthesizers**. Thus it's possible to carry out all the

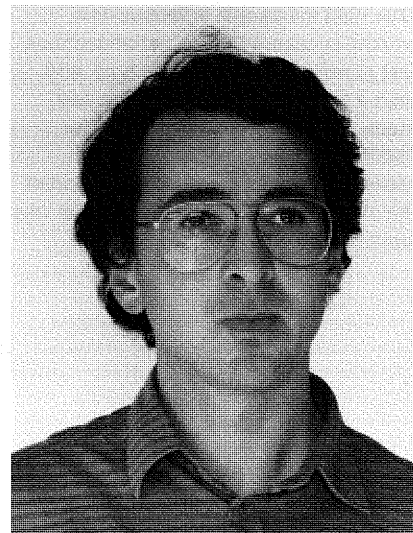

Klaus Pai, Dipl.-Ing. (FH), is a development engineer at Motorola in Taunusstein.

previously mentioned measurements within a freely selectable frequency band. The software that we've created for this is specially tailored to individual units and types of synthesizer and it's too structured for use with other units. I don't find it meaningful to produce a global program for this".

The workbench of a radio-set designer: Mobile Tester SMFP 2, Digital Multimeter UDS 5, two Signal Generators SMPC plus a programmable Power Supply NGPU.

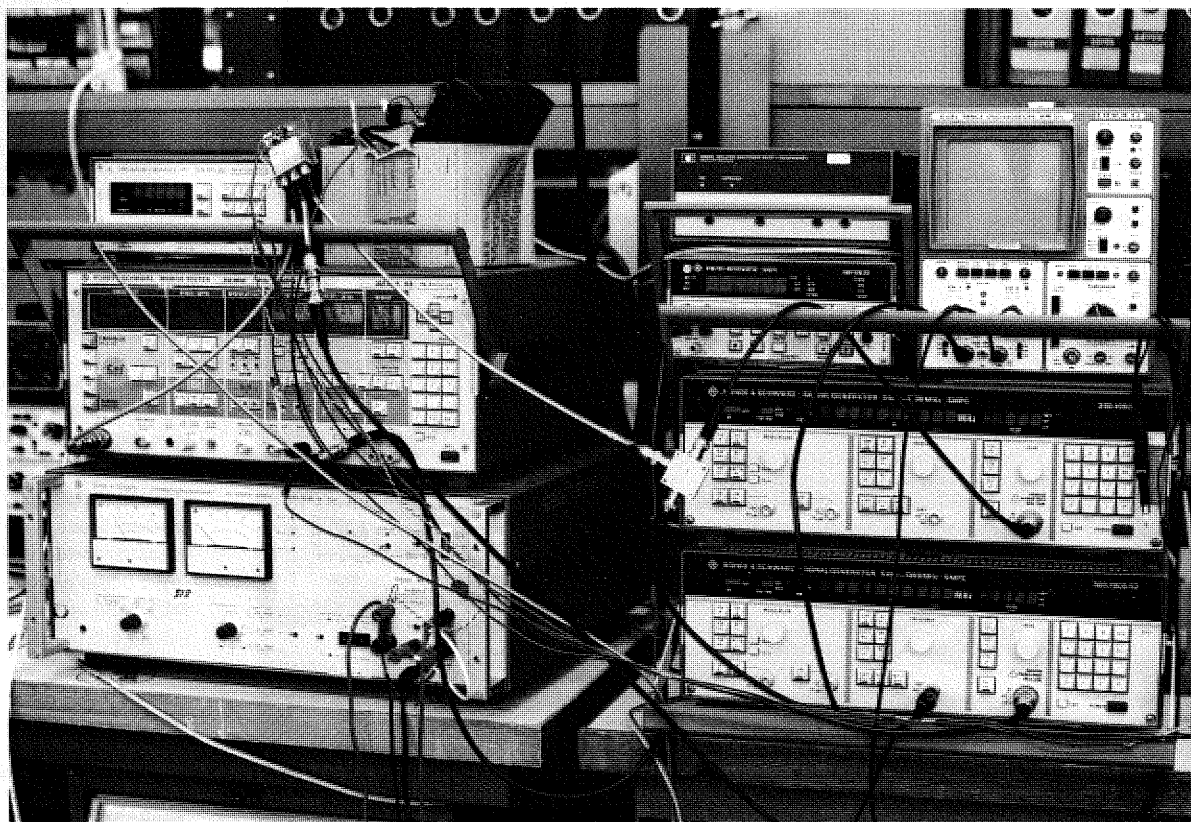

Until 1983 the people in Taunusstein worked successfully with radiotelephone test assemblies of the SMDU type, and then a fast but efficient transition was made to the SMFP and SMFP 2. "The SMFP is very much an allround test assembly and can handle a major part of the measurement chores that arise in very short times".

Blocking Bandmitte [dB]

T [°C]	-10.0 MHz	-1.0 MHz	-0.1 MHz	+0.1 MHz	+1.0 MHz	+10.0 MHz
-20.0°	104.2	100.4	84.4	84.6	100.6	104.2
-5.0°	104.2	101.0	93.0	93.0	100.8	104.2
+10.0°	104.2	100.8	95.0	95.4	100.6	104.2
+25.0°	104.2	101.6	96.2	96.2	102.2	104.2
+40.0°	104.2	102.2	96.2	95.0	102.2	104.2
+55.0°	103.8	102.2	96.2	96.0	102.2	104.2

Typical results from a blocking measurement on a mobile radio at intervals of between 100 kHz and 10 MHz above and below the receive frequency in a temperature range of -20 to +55°C.

In Grödig Pfitzner produces radiophones for big customers

A lot to do in the test-shop

If you want to survive in the hard-fought market for VHF and UHF radiotelephones, you not only need good equipment but also to produce it in series that can be adapted to different user needs speedily and cost-effectively. What is more, if your production is geared to big customers, quite considerable demands will be made of the testing aids you use.

At its Grödig works near Salzburg, Pfitzner, an affiliate of H. Pfitzner Nachrichten-

technik GmbH in Frankfurt, produces primarily mobile radios and fixed radio installations. The major customers are authorities and institutions like fire brigades, police forces, rural constabularies, energy utilities, and a large quantity is also exported.

Engineer Reinhard Lütte, executive secretary at the Grödig plant, had good reasons for procuring R&S radio test systems: "With the appearance of the SMFP



Engineer Reinhard Lütte is executive secretary at the Grödig works of H. Pfitzner Nachrichtentechnik GmbH.

on the market, there was just the compact test assembly we were looking for. This was not only our own decision in Grödig but also one shared by the company in West Germany and by our branches abroad. In the definition of acceptance measurements it was also found that most of our customers likewise work with R&S radio test systems, computer-controlled setups in particular".

Here a PUC-controlled SMFP 2 is examining a mobile radio from the T-8000 family. The results are logged by a PUD 3.



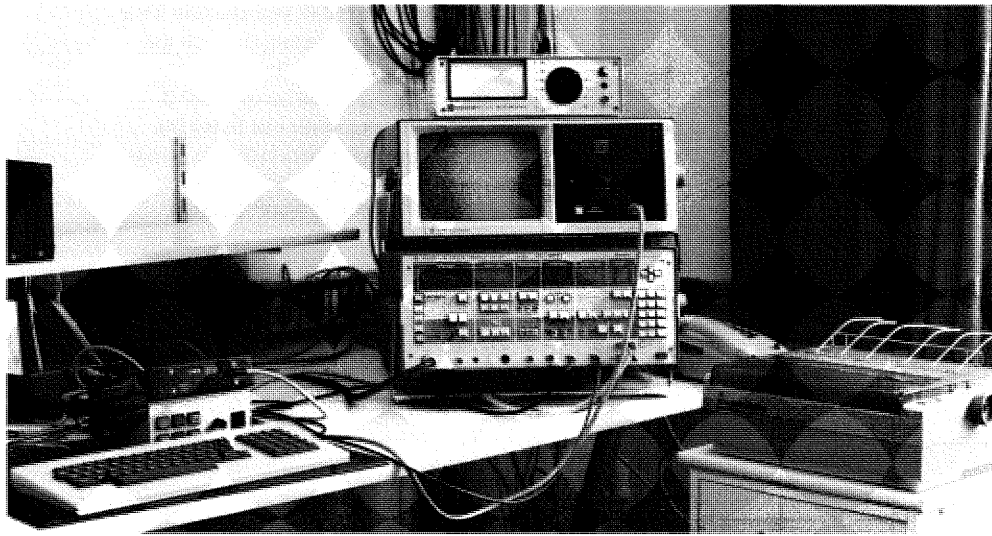

Another test assembly in action: SMFP plus Process Controller PPC.

In Grödig there are consequently SMFP and SMFP 2 testers for measuring 200 to 300 radio sets daily, some of these sets going through the procedures several times. The test assemblies are controlled

by Process Controllers PPC and PUC; the basic software and in part the application software come from Rohde & Schwarz, whilst the "finer points" are harmonized with the particular customer. "The contact

with our headquarters and with our customers is such that we exchange floppies with data so that we can immediately compensate tolerances in measurements. Thus **high quality** can be expected of our radios. The advantage is simply that everyone knows from everyone else what measuring aids he's using and at what level we're all working".

Currently two special equipment series are being produced: first there is the T-8000 family for 4 m, 2 m and 70 cm, and then there is the TMC-82, likewise for all bands. The T-8000 is a simplex or semi-duplex unit with PROM-based channel programming, while TMC-82 is processor-controlled, ie software.

"The assembly of the electronic modules is in part farmed out to another company and we concentrate on **assembling ready units and test operations**". Once the units have gone through the various continuous tests, like an **active burn-in** for instance, and passed the R&S test assemblies without fault, they are given the green light.

Swiss PTT: free test campaign for NATEL car telephones

A firm grip on complex signalling

The **NATEL car-telephone network** has been in operation in **Switzerland** since the end of 1977. There are 4500 subscribers in network A and network B will, **after extension**, have **9000 subscribers**. In the setting up and clearing down of car-telephone calls as well as during the actual call (when a subscriber drives into a tunnel, etc) there are **complicated signalling procedures**, which can now be measured **for the first time strictly in line with specifications** using Mobile Tester SMFP 2 (full-duplex capability) and Radiocode Test Set SCUD.

In order to obtain a representative impression of the technical state of private NATEL sets, the **general PTT administration in Bern** announced a free and voluntary test campaign in Zürich. Some 800 subscribers took up the invitation and their sets were fully checked out within four weeks.

"In carrying out this campaign we were only interested in factors that are critical for the system, like signalling, RF power, receiver sensitivity", explained **Rudolf Ritter**, Dipl.-Ing. (HTL), responsible for mobile-radio operations at the general PTT administration in Bern. "With R&S's SMFP 2/SCUD test system it's now become possible, for example, to analyze a subscriber's identification in terms of frequency of the various tones, amplitude and burst length, and strictly according to specifications".

That is saying something, because as many as **eight different frequencies** (instead of normally five) are measured in a subscriber identification of **350 ms**. "And then there's the **clearing signal**, more or less the **going on-hook**; this, according to specifications, should be $100 \text{ ms} \pm 10 \text{ ms}$. In practice you find that it ranges from 0 to 200 ms".

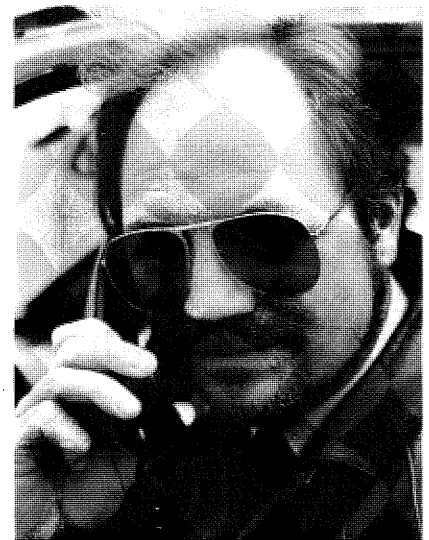

Rudolf Ritter, Dipl.-Ing. (HTL), of the general PTT administration in Bern is responsible for mobile radio.



Remote measurement as a special application: the test setup is in the hut, contact to the car telephone is by way of a 10-meter cable and a special interface (devised by the PTT).

Measurement of the clearing signal has become possible with SCUD. The problem used to be that different people applied different standards when testing. This produced statistics with a poor confidence level. "Now we have relatively hard results of course, which means good statistics".

Software support by Rohde & Schwarz was especially praised by Ritter: "We got very good support for some machine instructions, without which none of this would have been possible. And now everything's true to standard and specification". SCUD was originally acquired especially for NATEL applications, but it is due to get a lot more work from about 1987 onwards when the NMT network starts up. This will be a system for 120,000 subscribers, with some 450 transmitting stations and a total of 4000 channels.

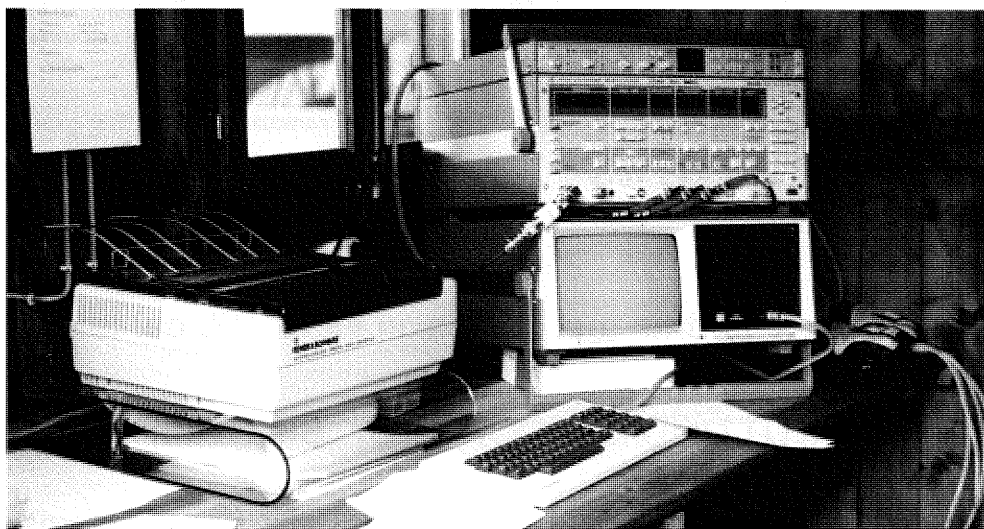

There's space in the smallest hut: SMFP 2 and SCUD fit snugly in the corner while, close at hand, PUD 3 produces hardcopy results.

The PVE in Vienna: planning, operations, maintenance

Putting equipment to the acid test

The matters that concern the office for defence engineering in Vienna range from physics through to mechanical engineering. It is directly responsible to the Austrian ministry of defence and is divided up into specialist sections. One of these is the testing and research establishment for low-voltage and power engineering in

Vienna, known as PVE for short. This is the central instance for planning, operations and maintenance in the field it covers.

Helmuth Buchsbaum has been a testing technician and acceptance official at the PVE for more than 20 years: "All radio sets have to come through here, for instance,

"When you look at NMT, you see that it's a centrally controlled system in which the exchange says what's to be done. A measuring facility made up of SMFP 2 and SCUD consequently has to tell the radio mobiles what to do. In NATEL things are the other way round – there the mobiles say what they want". In other words: the PTT makes high demands of its instrumentation, and has not at all been disappointed by the SMFP 2/SCUD combination.

from their introduction through to their retirement". For his measurements he uses an R&S Mobile Tester SMFP 2, linked to a Process Controller PUC. Power comes from a programmable DC Power Supply NGPU. Acceptance measurements are conducted in a shielded cabin so that the values measured remain free of any envi-

VHF-COMMUNICATION EQUIPMENT
TYPE CSF-60A FLEETPHONE 60W

MEASUREMENTS

MI-31680 transmitter-receiver
 ser. number: 2573

MI-31683 Power supply
 power input :

transmit(350W) :	360
standby(100W) :	123
line voltage(V) :	220

transmitter section

rf-power (60W/50ohms)	60.4
rf-frequency (MHz)	38.20009
frequency-offset (Hz)	90
mod. sensitivity	
for +/-15kHz swing at 1kHz af (mV)	31.4
Pos.modulation (kHz)	12.6
neg.modulation (kHz)	17.5
S/N ratio (>45dB)	65
harmonic radiation (dB)	40
audio response (0.3-3kHz;+1to-3dB)	-7.6/+1.7
distortion :	
with limiting(100mV,1kHz,12%)	10.9
without limiting(10mV,1kHz,4%)	5.5

receiver section

rf-frequency (MHz)	38.2
mid.frequ.offset (kHz)	.7
squelch-sensitivity(uV)	.12
quieting sens. (.4uV;20dB)	.33
selectivity (kHz)	
-6 dB	26
-20 dB	37.6
-40 dB	47.5
-60 dB	56.9
channel selection (+/-40kHz;100 dB)	>100/>100
audio response (.3-3.5kHz;+1to-6dB)	-12.3/+1.7
audio output (3ohms,10%dist.;W)	.99



Helmuth Buchsbaum is a testing technician and acceptance official for radio equipment at the PVE in Vienna.

◀ Typical test report for a radio set, printed out by an R&S PUD 2.

In the shielded cabin: a PRC-77 being tested by SMFP 2 and PUC. ▼

ronmental influences. The test setup also occasionally goes on the road: "For the recent introduction of a new system of radio sets for the army we used the R&S setup for quality testing at the producer's plant".

For this newly commissioned system there is now the task of creating appropriate software. "We intend, based on a given flowchart, to have the testing software from status measurement through to troubleshooting at module level written by RSÖ (Rohde & Schwarz Austria) for our instrumentation".

The PVE has had a long period of familiarity with R&S instruments. It still uses the first R&S radio test set SMDA, and signal generators like SMLR are still in regular use. It is not easy to part with old and trusty friends.

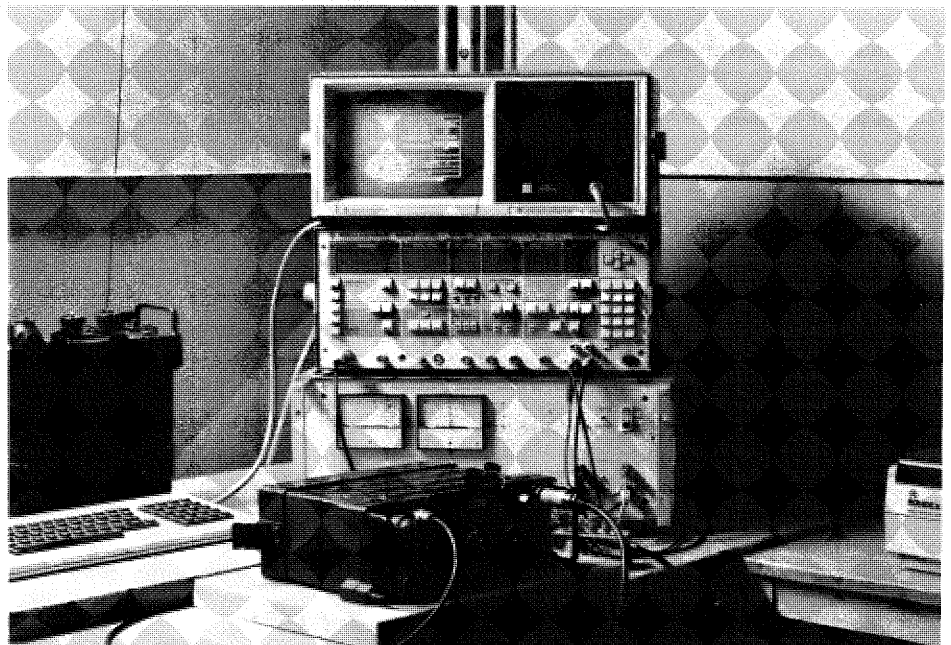

Quality assurance with emphasis in Flensburg

Storno calling – over



Engineer Kjeld Bülow Thomsen is quality-control manager at Storno Electric in the Flensburg works.

Test setup for NMT units: two Radiocode Test Sets SCUD and a duplex Mobile Tester SMFP 2 get to the bottom of the matter.

This is where car telephones have to show what they are worth. The computer-controlled SMFP 2 are integrated into a test system devised by Storno.

The name **Store Nordiske** is closely associated with the big telegraph lines of the north: the company still operates lines like that from Europe to China, right across the Soviet Union. In its search for new fields of activity the company founded **Storno** in 1948 for the production of mobile radios. Storno, based in Copenhagen, employs some 2000 persons.

In the **Flensburg works**, established in 1967, some 600 persons are currently engaged in the production of all mobile and base stations of the range. These include car telephones for the Nordic networks and, since recently, also for network C. Engineer Kjeld Bülow Thomsen is responsible for quality control for goods inward inspection and the maintenance and calibration of measuring instruments

and also for the development of test systems for new products. "We test ICs and we test crystals 100% with Rohde & Schwarz's Vector Analyzer ZPV. For the equipment in network C very high frequency accuracy is called for, 1 ppm for transmitters alone".

Thomsen uses a great deal of **computer control** and **computer networks**. For the testing of radio sets he has set up new test lines with 16 R&S Mobile Testers SMFP and SMFS 2 plus 15 Radiocode Test Sets SCUD for selective-calling and car-telephone simulation. "To be able to supply TACS units for example, special calibration systems and quality-control measures are necessary, otherwise you won't even be certified as a supplier".

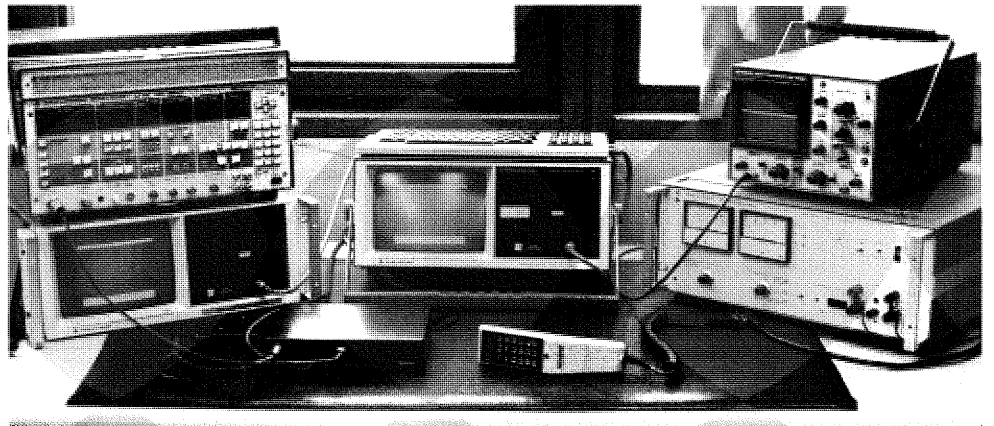

For radiocommunications Storno produces units whose system specifications are given by the control unit; the radio itself is a standard item and is tested as such. Here R&S-produced software is primarily used, for NMT units too. But there is not only a lot of software in the test systems nowadays but also in the processor-controlled radio sets: "The software of future equipment families will be very elaborate. We'll soon be working with 256K EPROMs so that we can get the software into the units at all".

As early as equipment development Thomsen ensures that subsequent testing effort will be as small as possible, because

testing time is expensive. "Today, in the electronics industry of the western world, a yield of about 50% is usual for ready prints and units. But that isn't good enough; at Storno we already have yields of more than 90%. Good workmanship, all-pervading quality assurance and reliable measuring instrumentation must of course produce better results: "Less than one percent of our units have a fault when they are unpacked, like a small scratch on the housing or a button that sticks".

Before units arrive in the hands of customers – some 85% of production is exported – they go through a six-hour burn-in. Here Thomsen keeps elaborate statistics about what fails and when.



High-grade measurement engineering on and under the bench: SMFP 2 integrated into the test system, SCUD, SMS, NGPU.

Rational testing methods shorten approval procedures at ZZF

Measuring when the day is done

The fast expansion and growth of telecommunications services plus the introduction of new forms of communication produced a stormy development in terminal sets. Domestic and foreign producers are swamping the market. The scope, the complexity and the significance of the approval procedures for private telecoms facilities are consequently also growing.

This trend led on 1 July 1982 to the creation of the **central office for approvals in telecommunications (ZZF)**, based in **Saarbrücken**. This is the specialized point of application for approvals in telecommunications, a task that was previously handled by the **telecommunications engineering centre (FTZ)** in Darmstadt.

In section T4-8 of the ZZF Karl Koch, Dipl.-Ing., is concerned with radio systems in public networks such as Rhine radio, the radiotelephone service, the European



Receiver measurements are a speciality of Karl Koch, Dipl.-Ing., of section T4-8 of the ZZF in Saarbrücken.

radio-paging service and receiver measurements on systems in private radio (pagers, taxi radio, police radio, etc) in as much as they are prescribed in directives. For mastering these wide-ranging measuring tasks Koch mainly uses instrumentation from Rohde & Schwarz: a Mobile Tester SMFP, a Process Controller PUC, two Signal Generators SMPC and two RF Relay Matrices PSU.

With the transfer of the SMFP and PUC from the FTZ, the ZZF changed from analog to IEC-bus instrumentation. "The automation of measurements had not only become necessary because of the constant increase in the amount of work facing us", explained Koch. "With an automatic test system we can also measure outside of normal working hours, something which we do in particular when it comes to measuring spurious responses in the range 100 kHz through

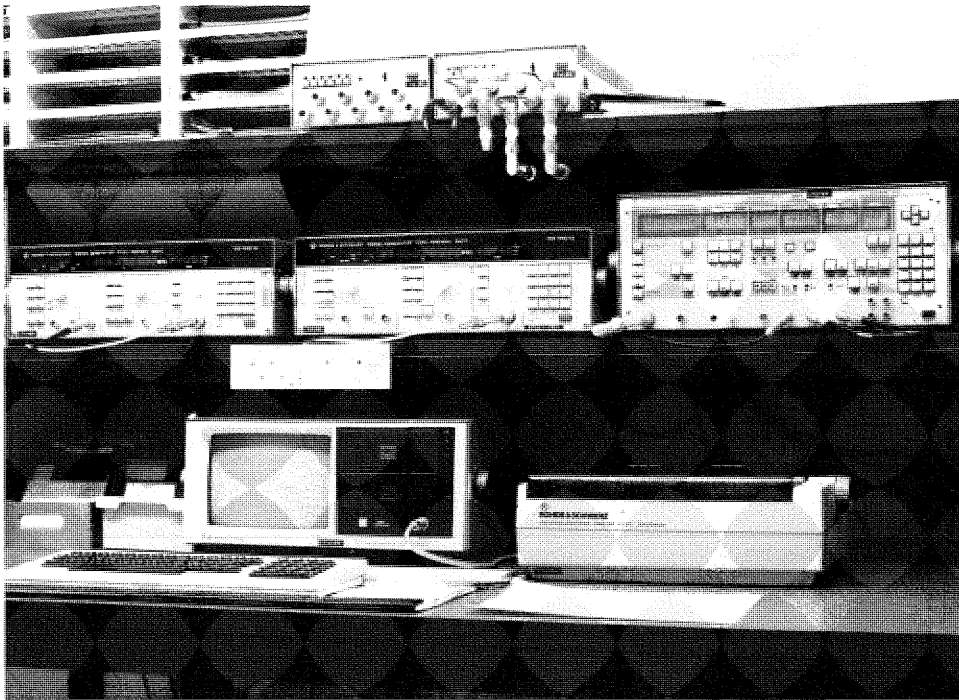

Equipment for public and private land mobile radio is thoroughly examined here for certification.

1000 MHz". Outside of normal working hours also means the weekend or parts of it. Such measurements of spurious responses can take something like 32 to 35 hours, depending on how many weak points are found and measured. First the noise quieting is tested throughout the frequency spectrum in increments of

5 kHz. "If there is quieting that's not caused by harmonics or subharmonics of the generator, optimization is made in 1-kHz increments to find the greatest degradation and then the level is varied until the reference quieting level is found. With this procedure, time-consuming as it is, one simply tries to play it safe.

Basically the Federal-German PTT is interested in seeing **economic use** of the frequencies that it makes available. This means that for certain radio systems, for example, a **minimum sensitivity** is prescribed so that transmitted energy can be kept as small as possible. With radio equipment that is operated in a public network, it is not only the active interference of a transmitter and receiver that is of interest but also the transmission quality of the entire system. "Thus we measure adjacent-channel selectivity and, something which at present is only prescribed for receivers, intermodulation ratio. In the foreseeable future we'll also be measuring **transmitter intermodulation ratio**, because with increasing density of radio stations and the field strengths that go along with this, transmitter intermodulation cannot be ruled out, which again appears as spurious emission. This can be a problem with **cordless telephones** in particular".

Koch, who has become **specialized in receiver measurements**, has been working with the two SMPCs since March 1983: "For the measurement of spurious responses in particular you naturally need signal sources that have **negligibly small harmonics** and large spurious rejection on the one hand and are also **very low in sideband noise** for measurements close to the carrier. A special advantage of the SMPC is its internal AF synthesizer, because then you can measure AF response without an additional generator".